

My robot

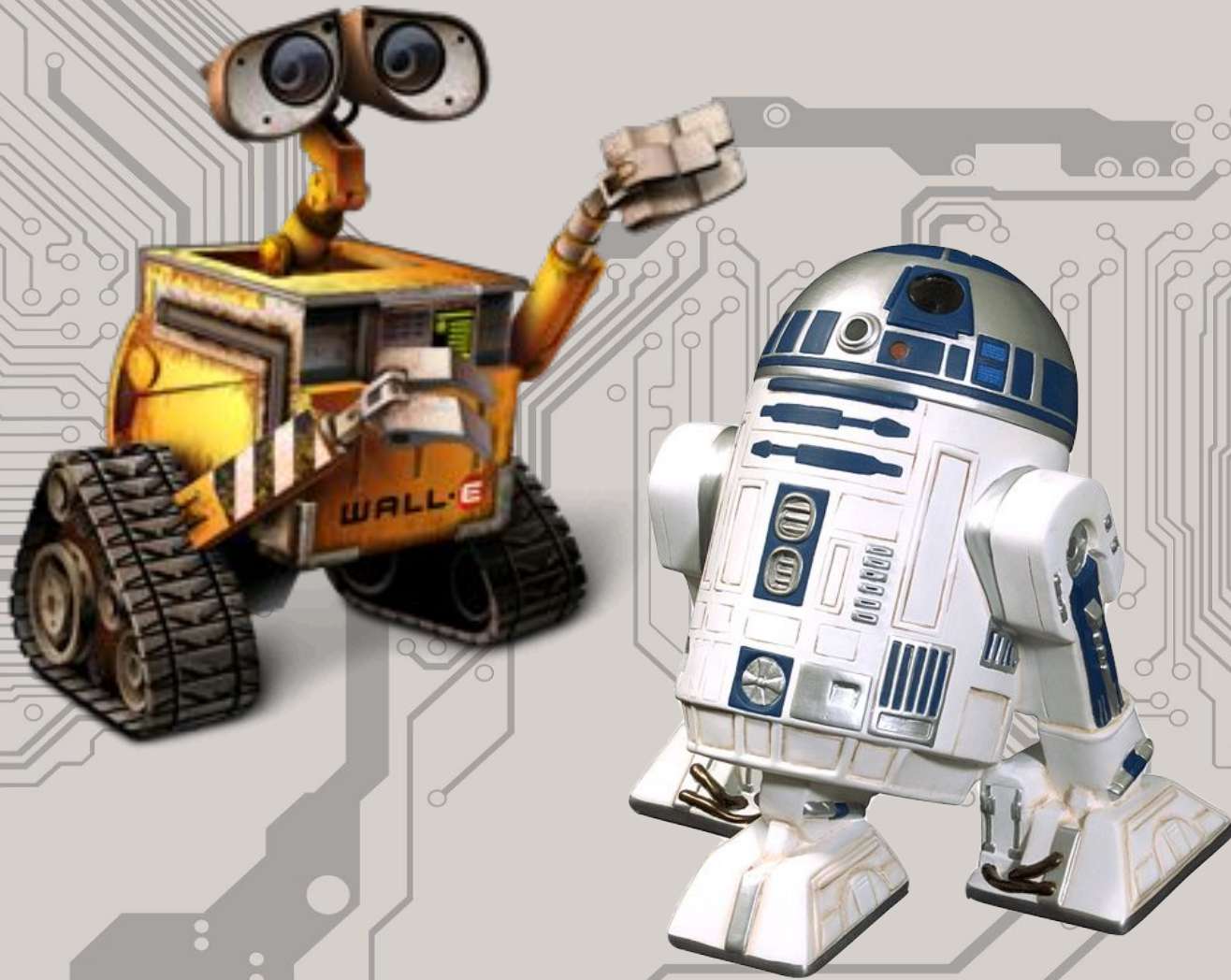

Student: Markelov Ilya

Grade: 8" B"

School: №7

Teacher: Tolchenova

M. A.

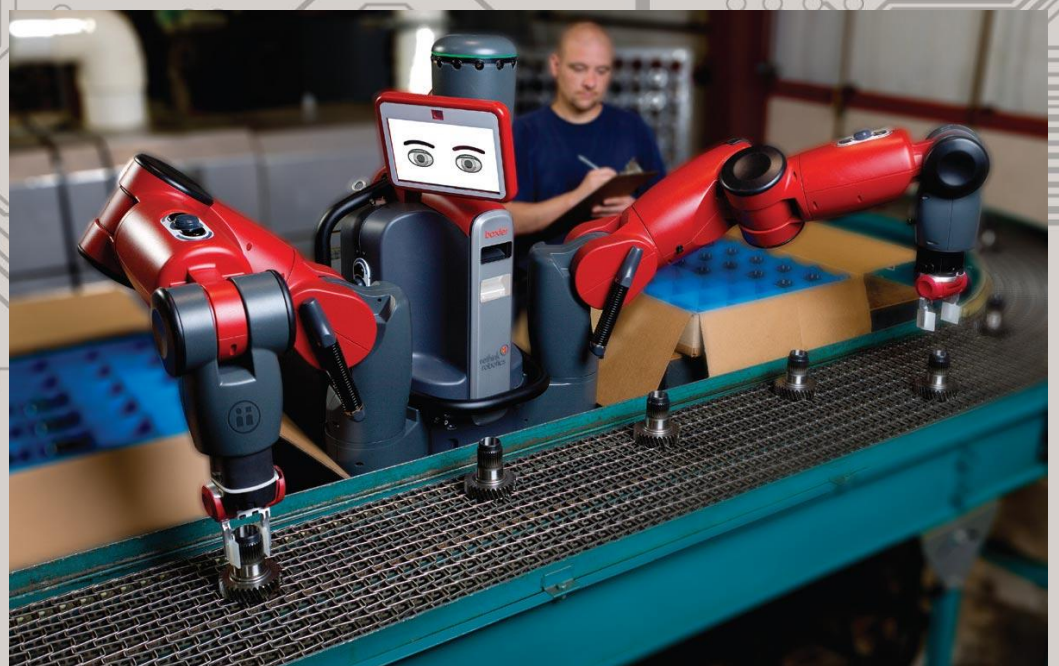

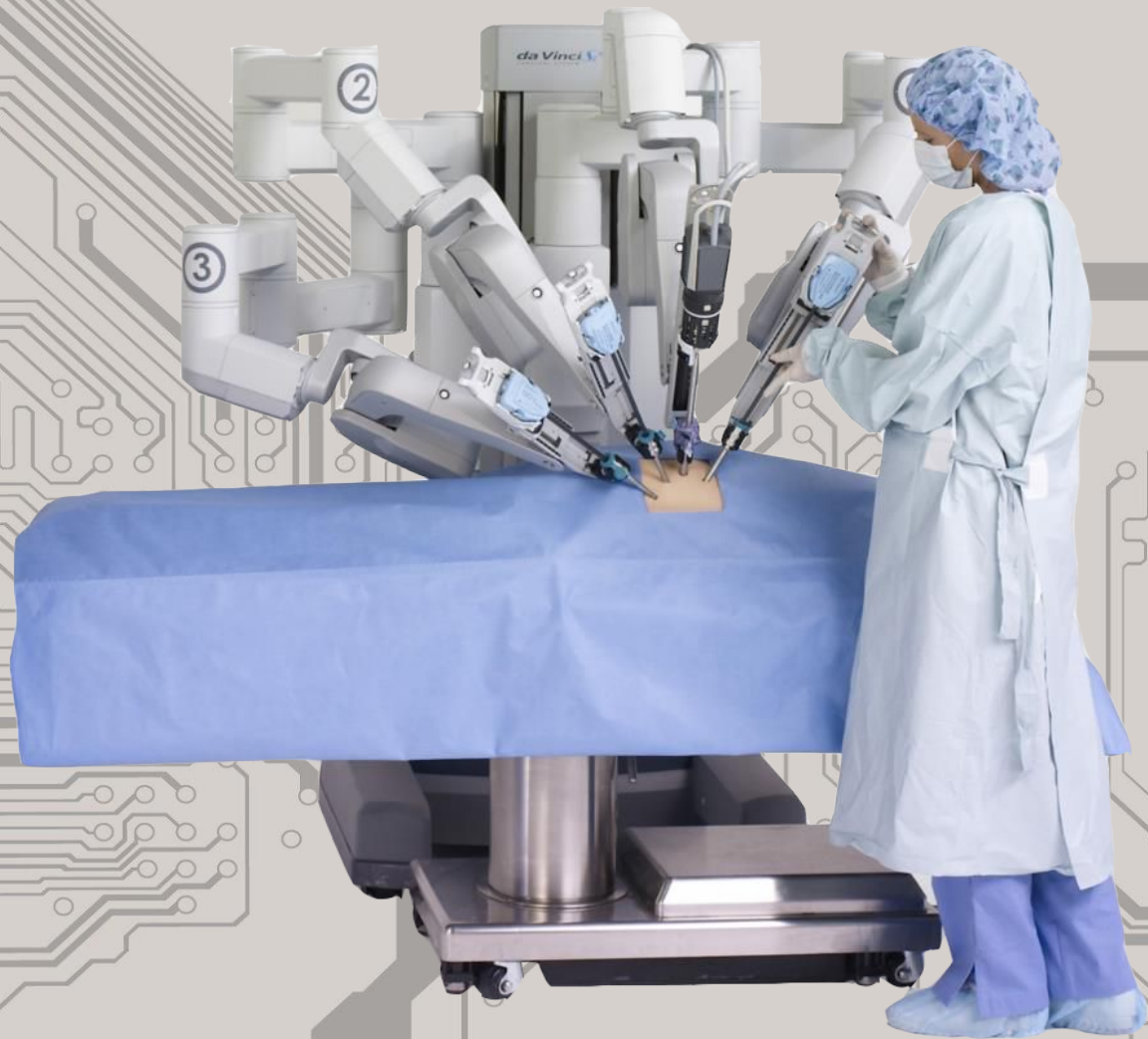



The aim of my work:

- Learn more about robotics
- Make my own robot





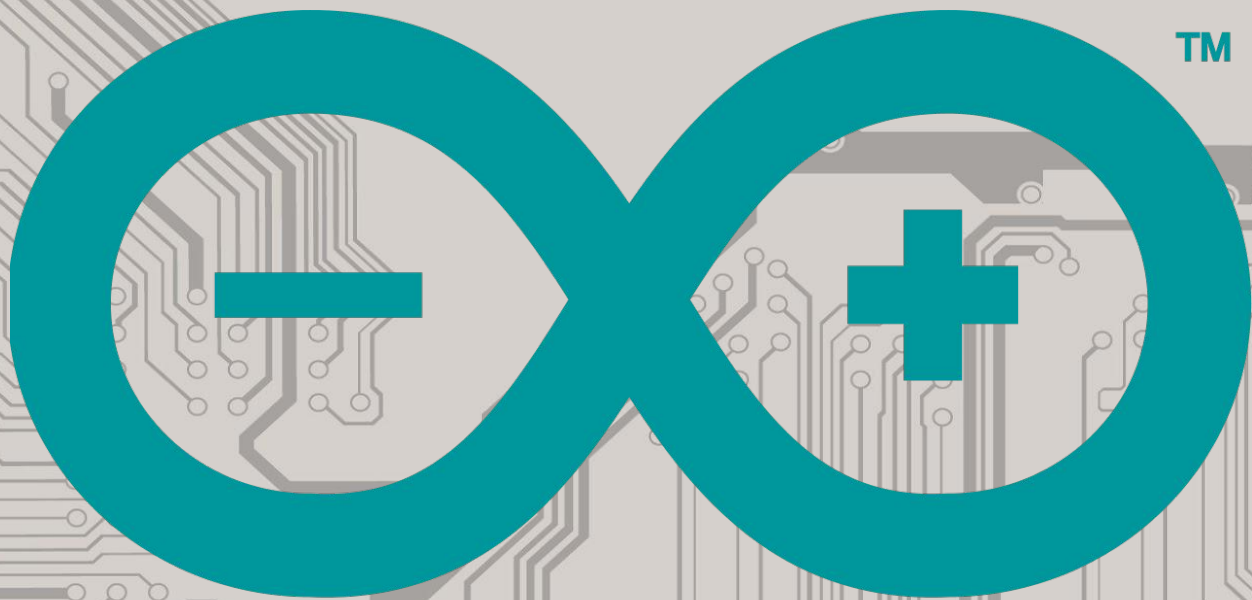

TM

ARDUINO

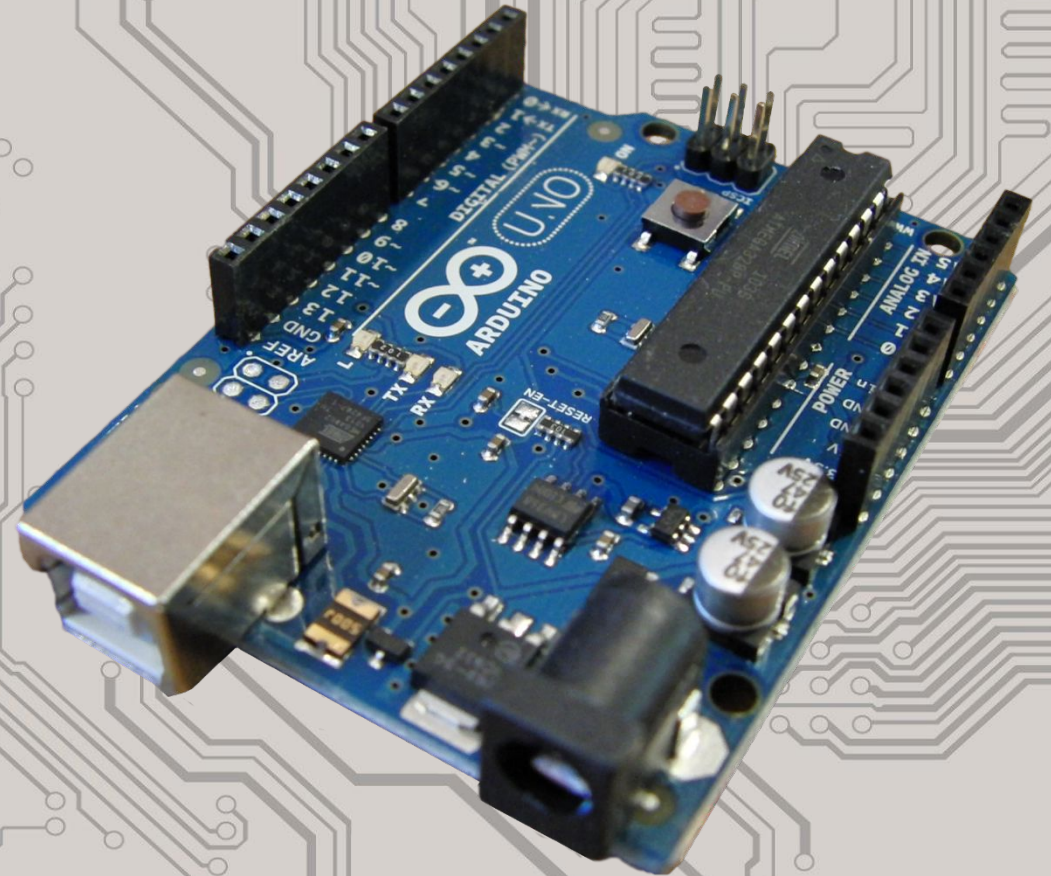



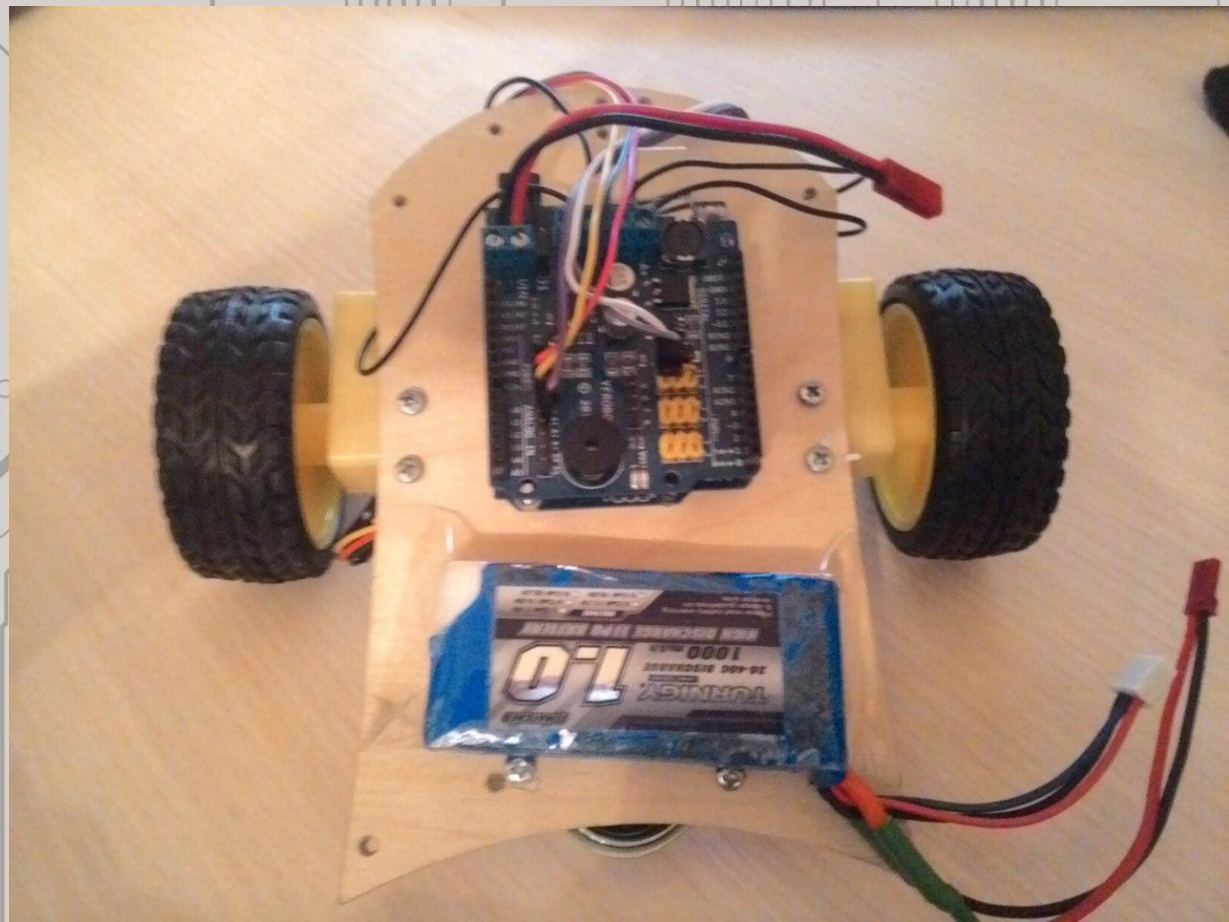
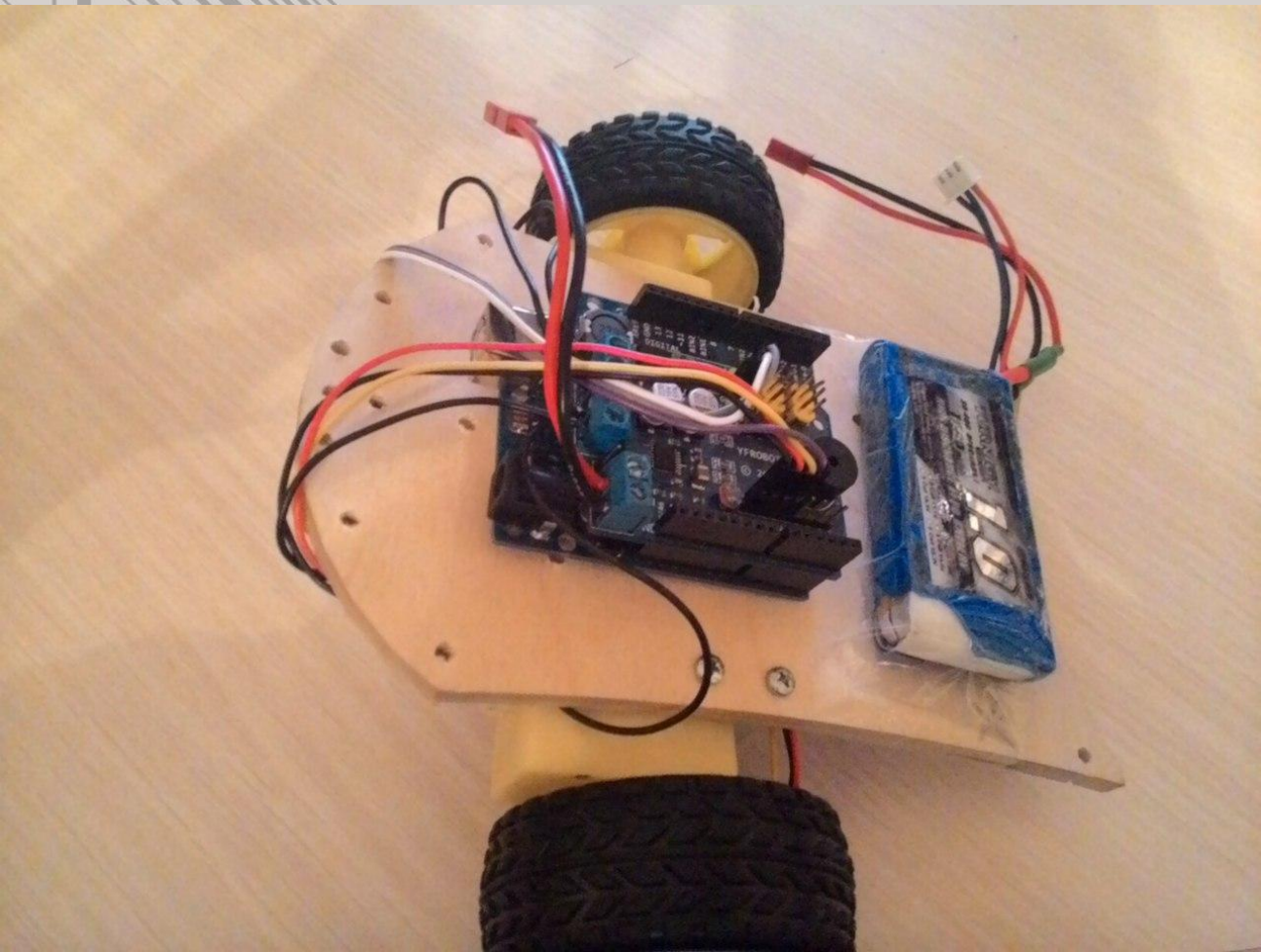

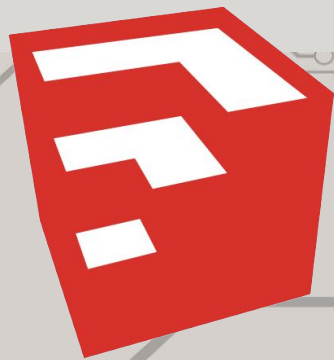
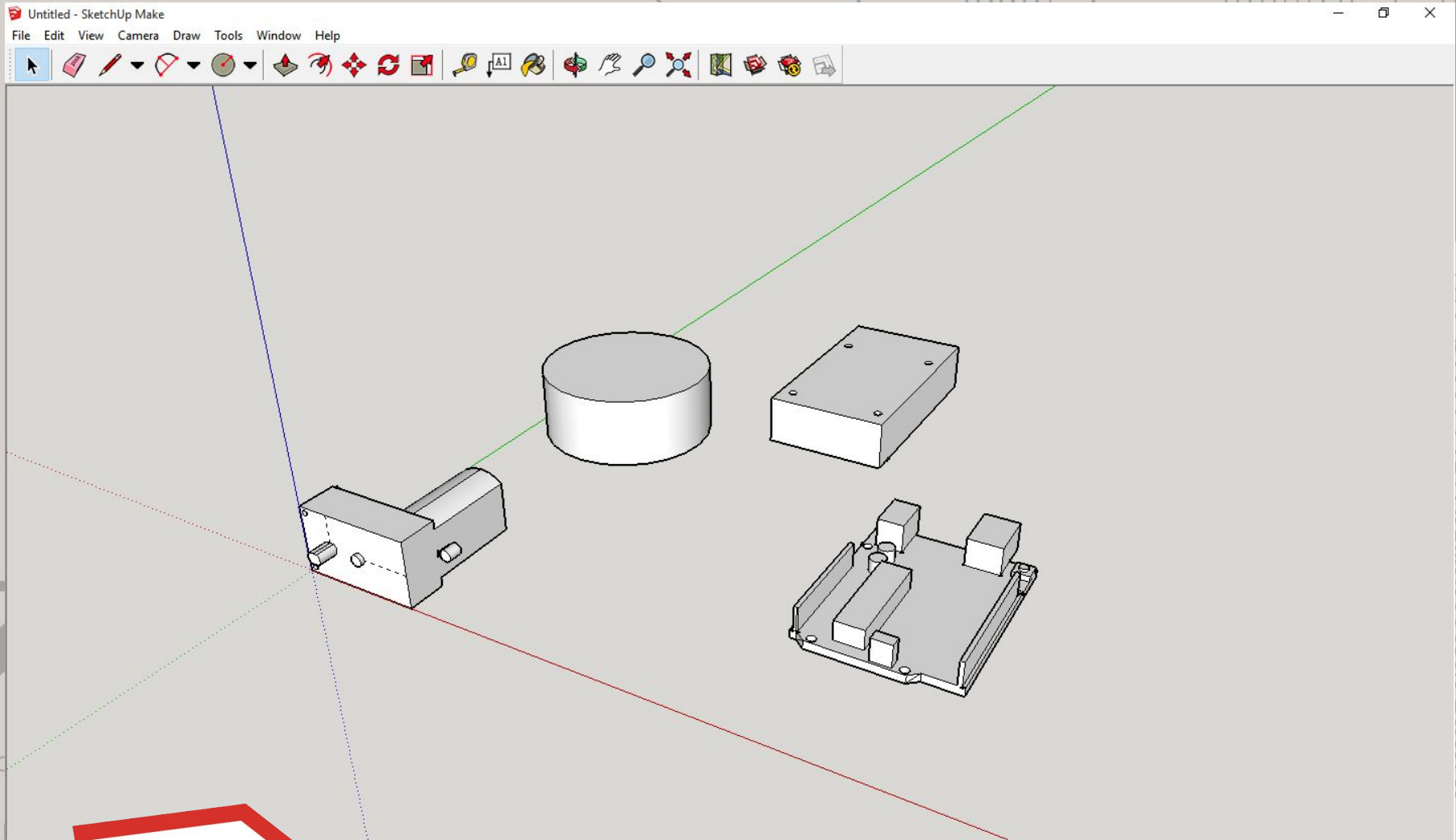

SketchUp

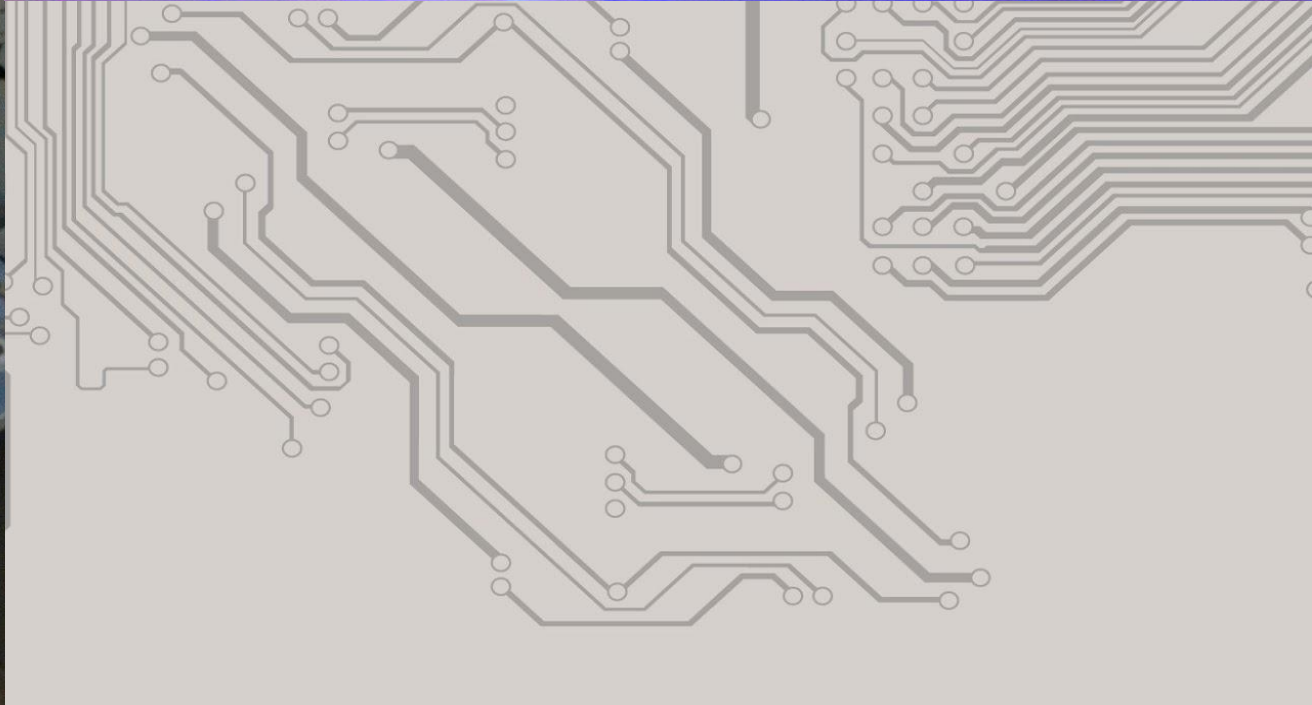
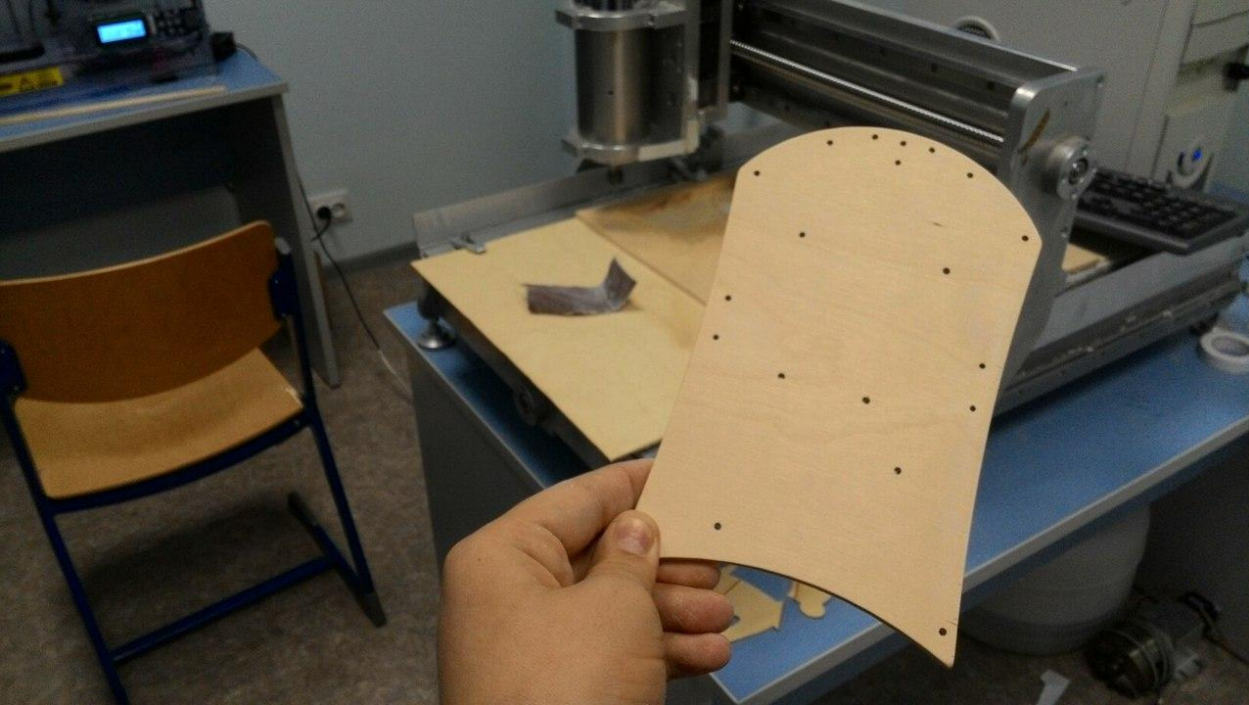
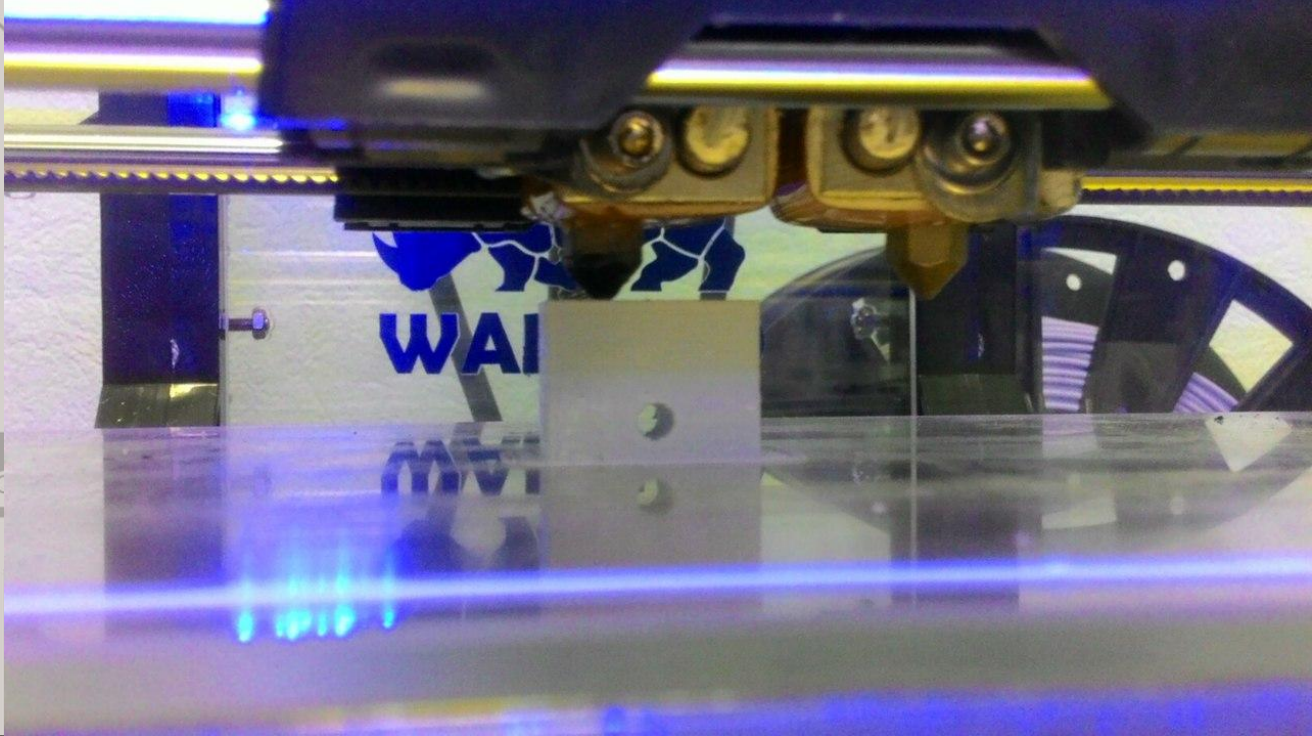
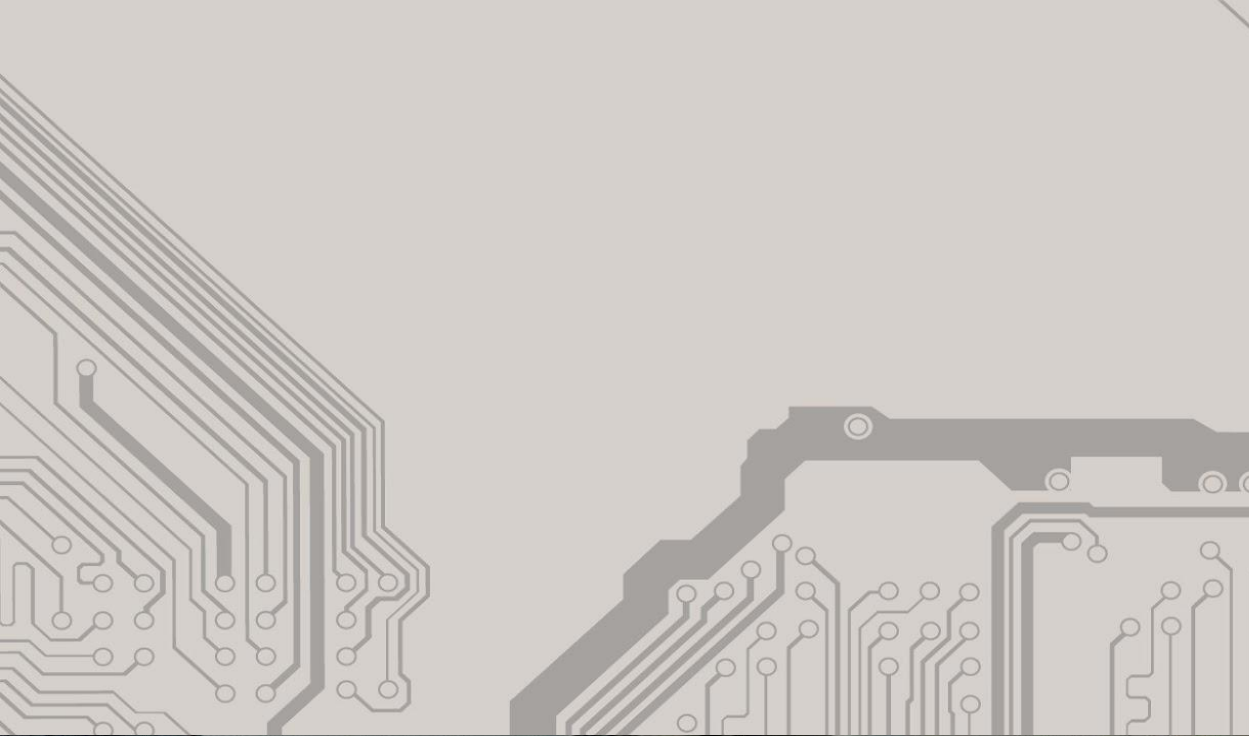

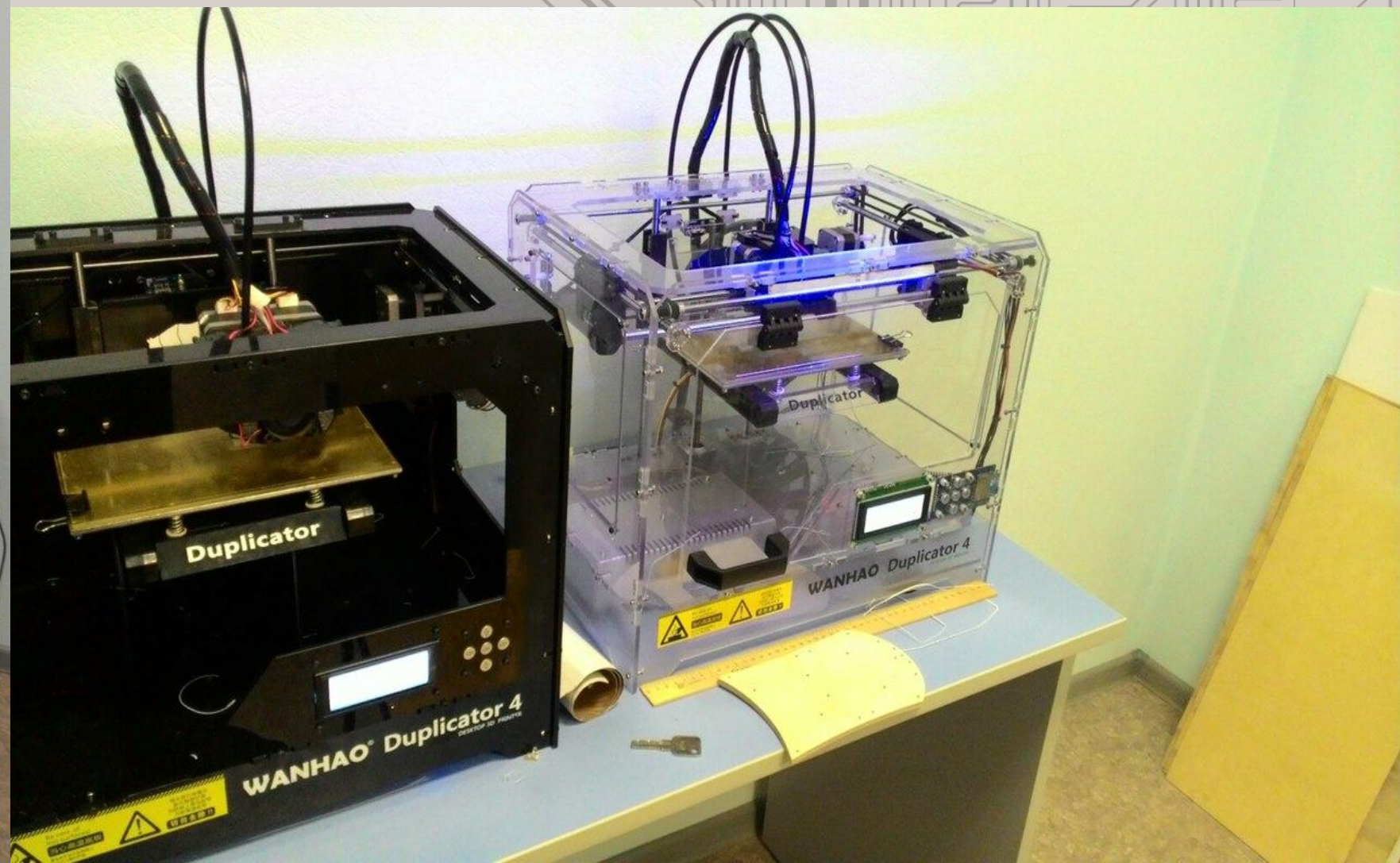

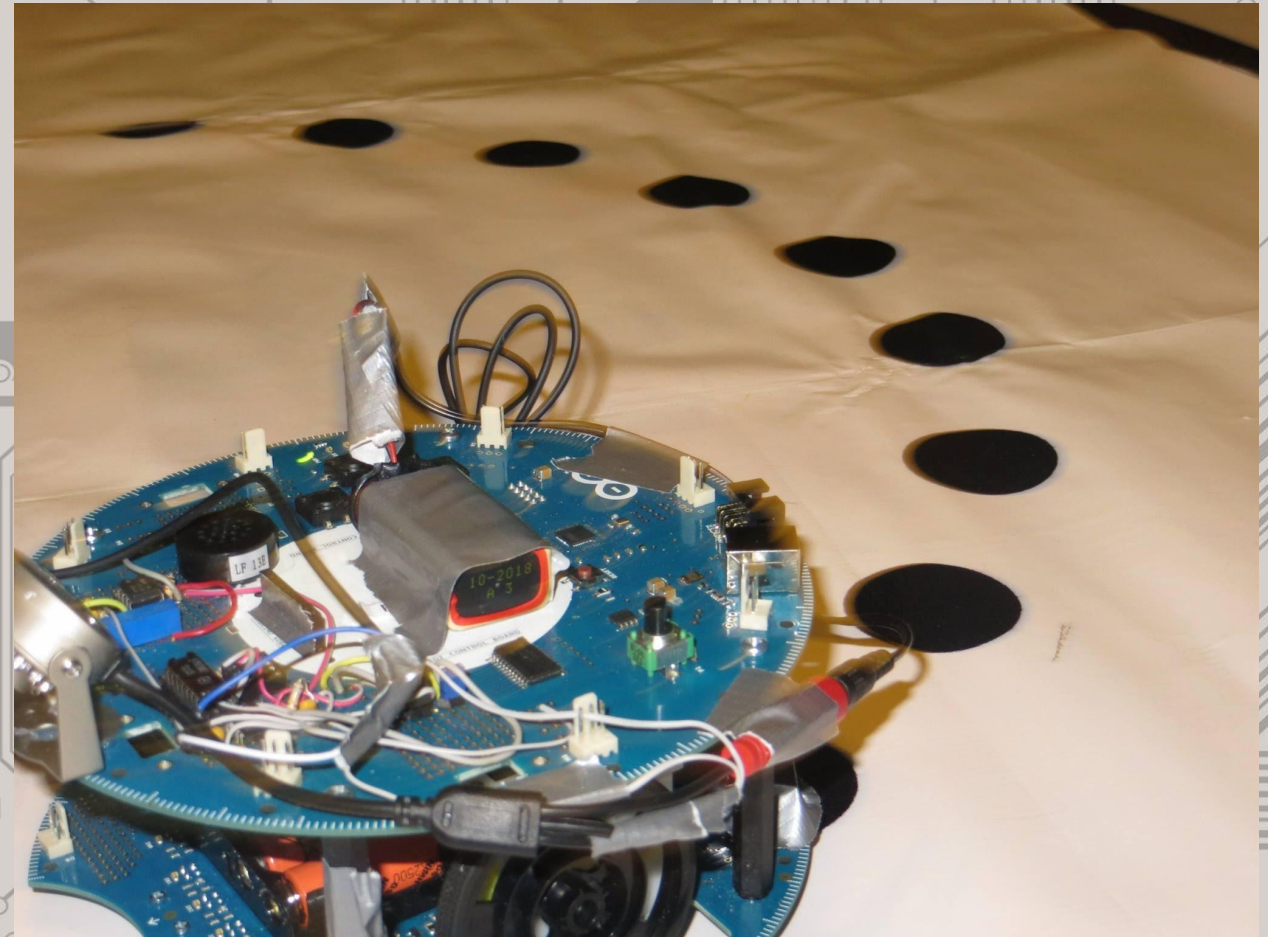
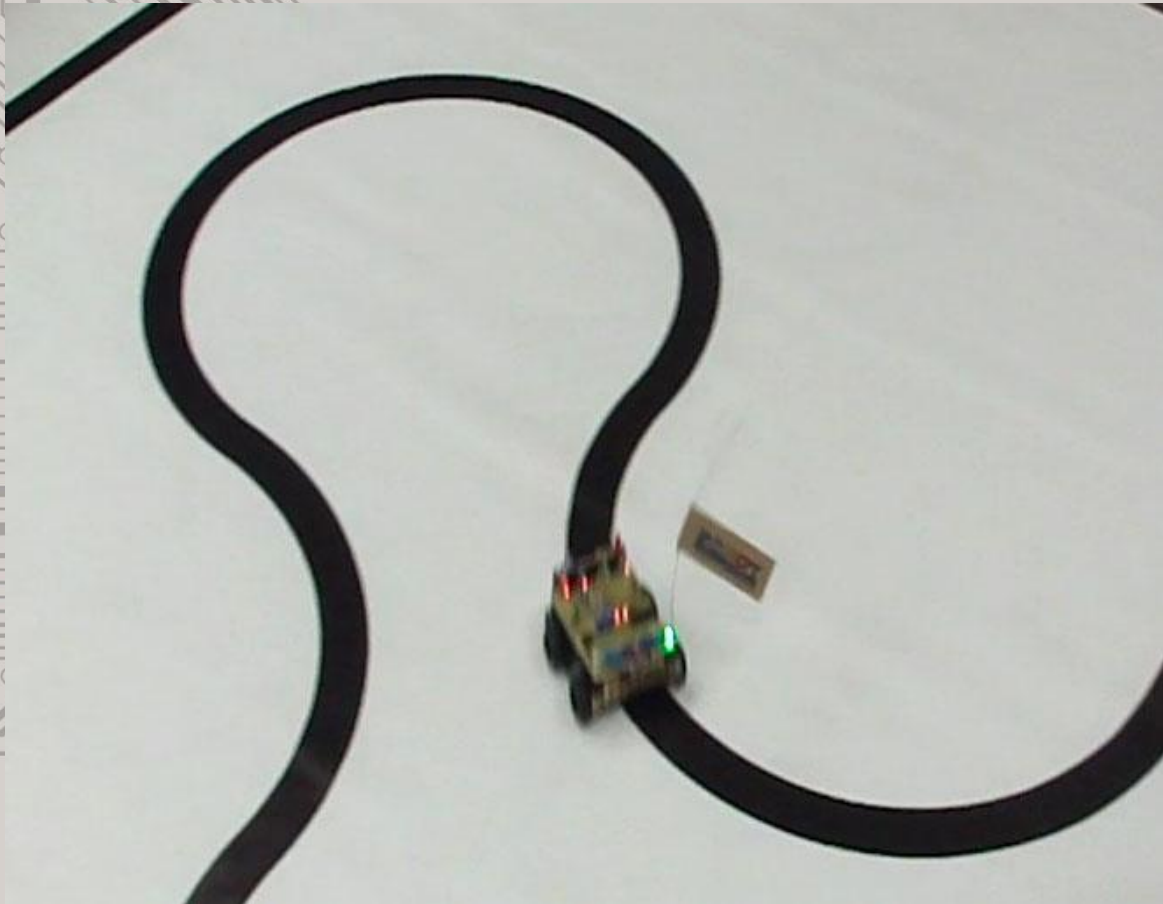



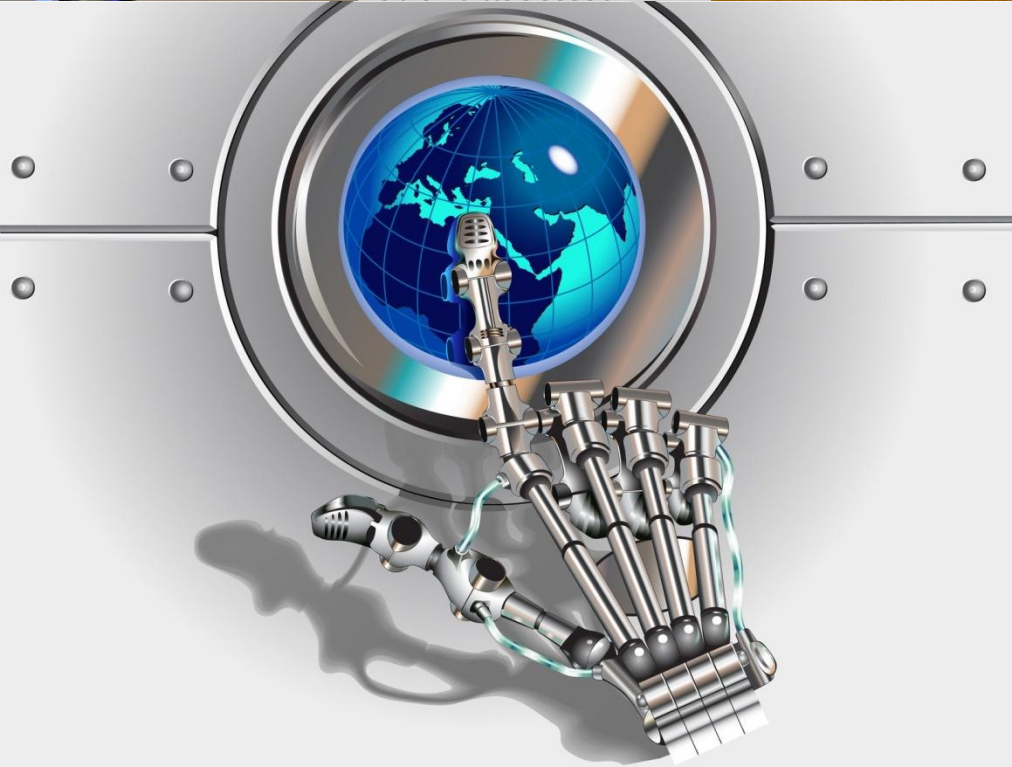
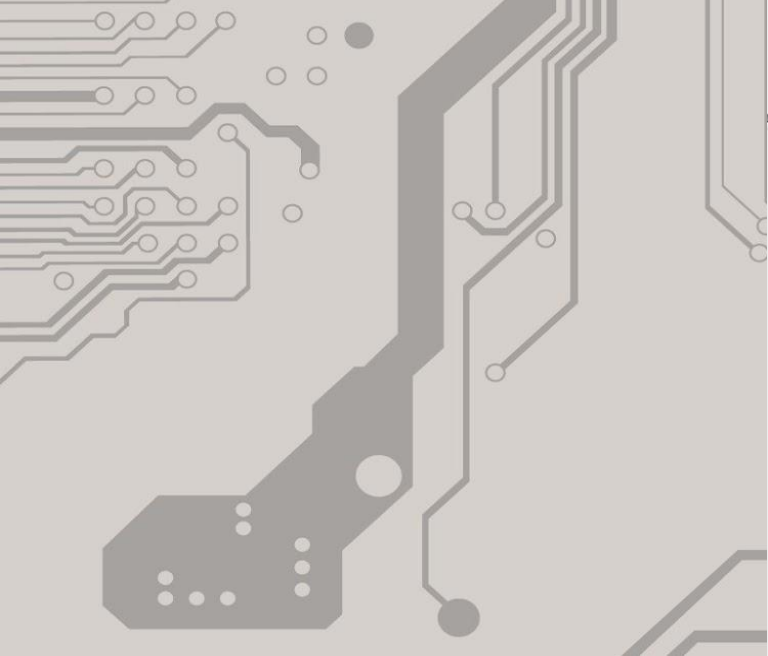

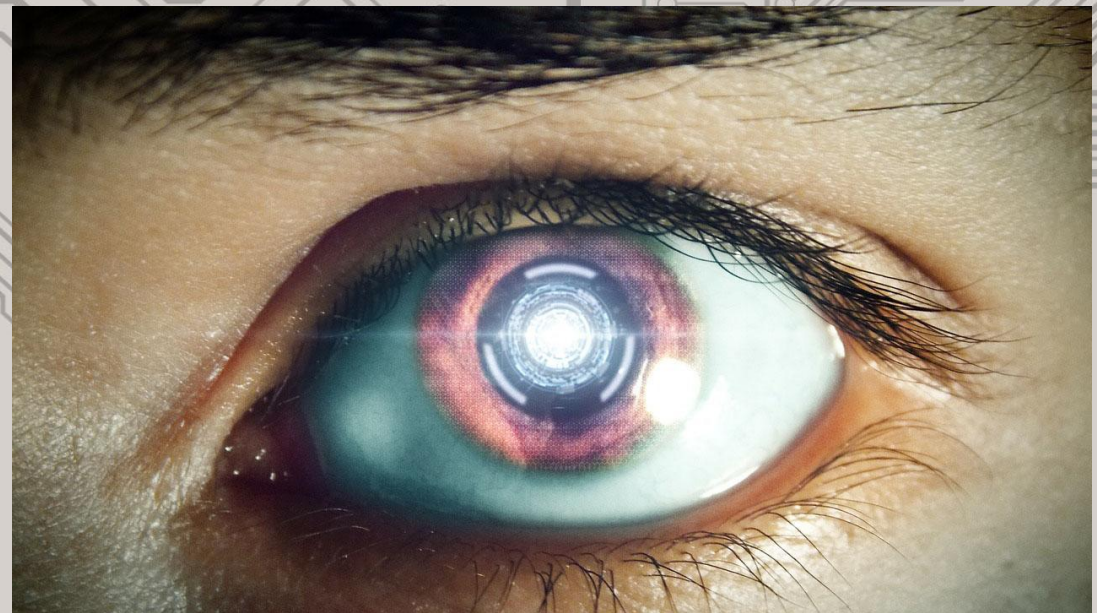
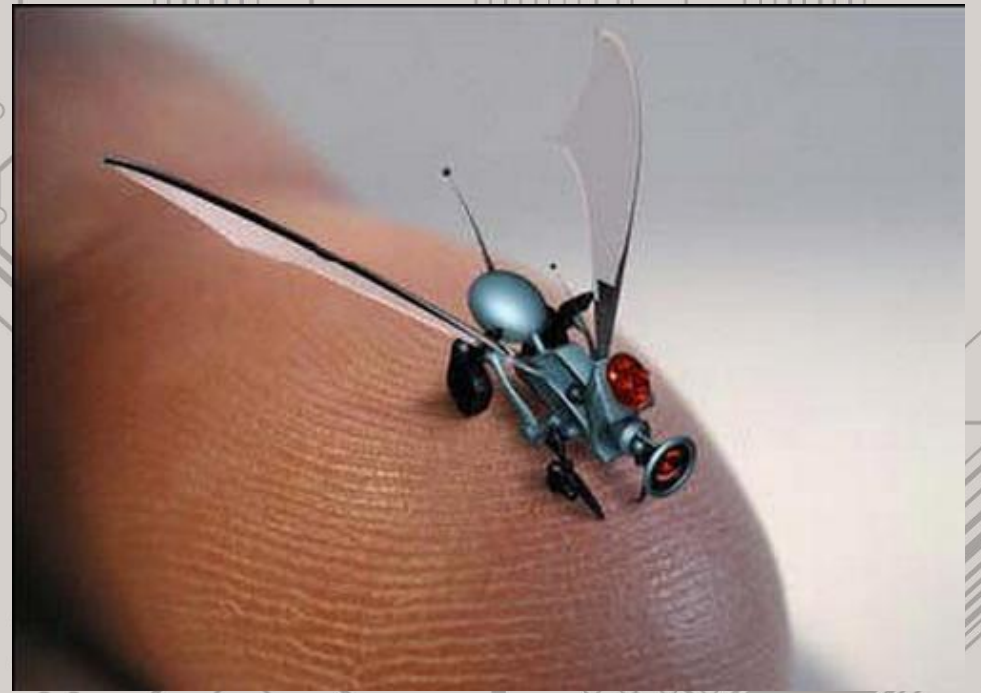
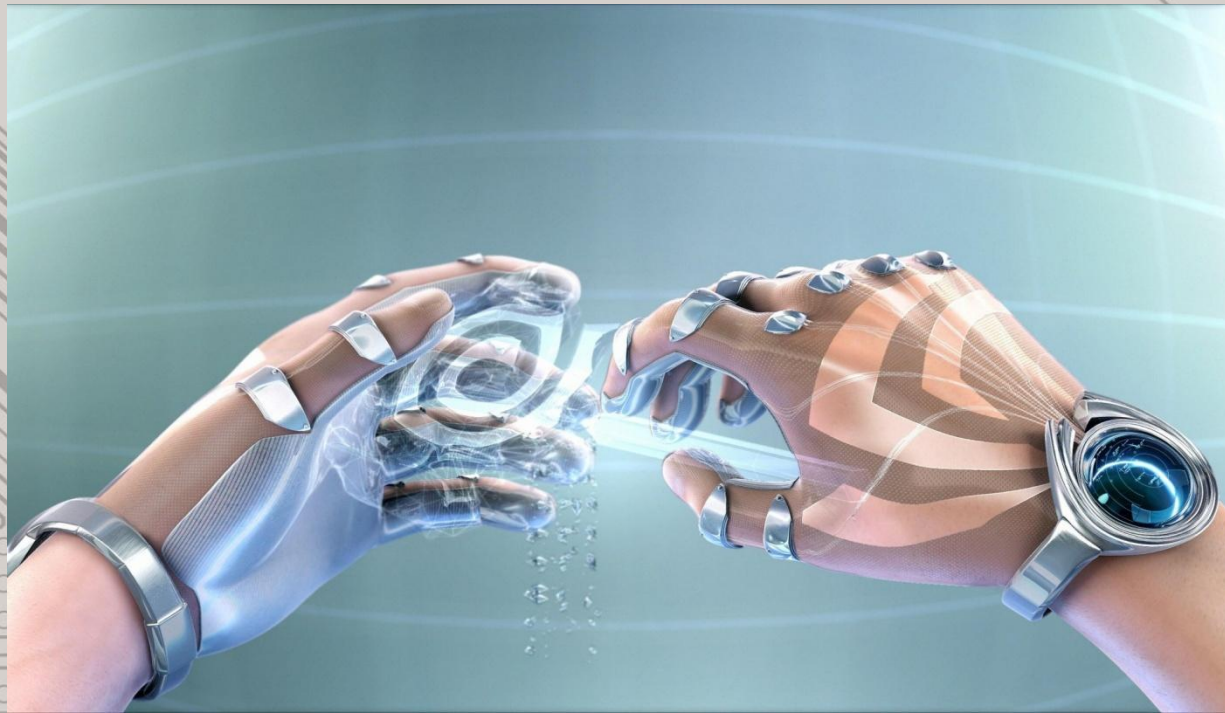

Thanks for your attention!

