

# Gene Expression Systems in Prokaryotes and Eukaryotes

- Expression studies
- Expression in Prokaryotes (Bacteria)
- Expression in Eukaryotes

# Gene Expression Systems in Prokaryotes and Eukaryotes

## Expression studies:

### 1. Analyzing Transcription

- Northern blot
- Micro array
- real-time PCR
- Primer extension

### 2. In vivo Expression studies

Use of report genes to study regulatory elements

### 3. Analyzing Translation

- Western blot - immuno assays
- 2D electrophoresis
- proteomics

# Studying Transcription

## Microarray technique - DNA chips

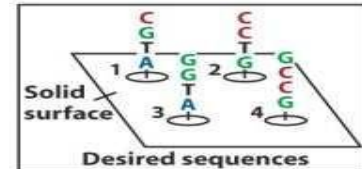
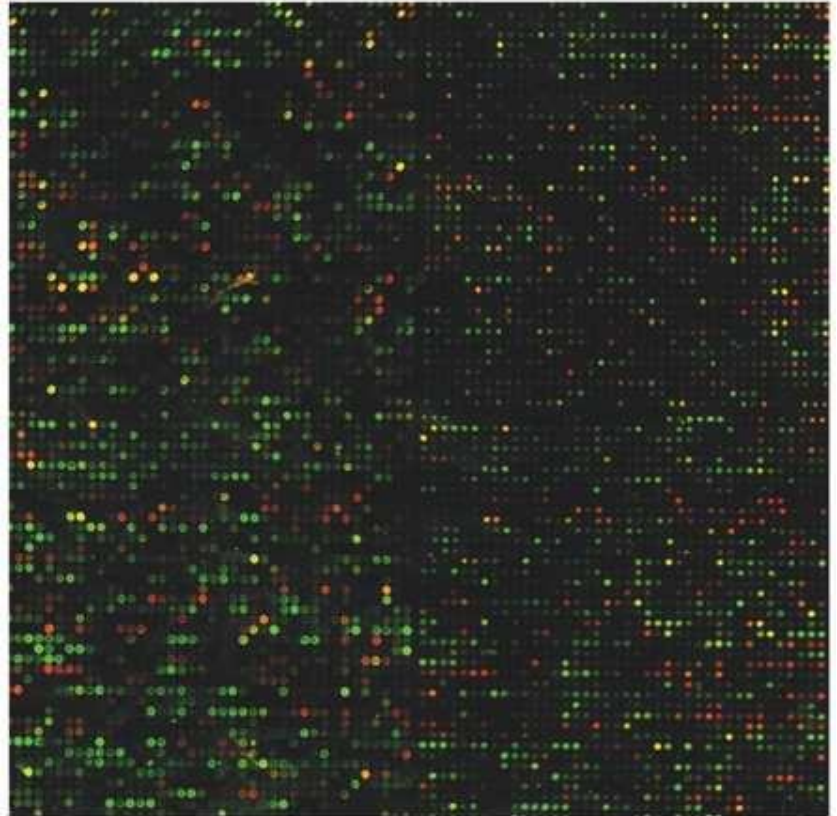
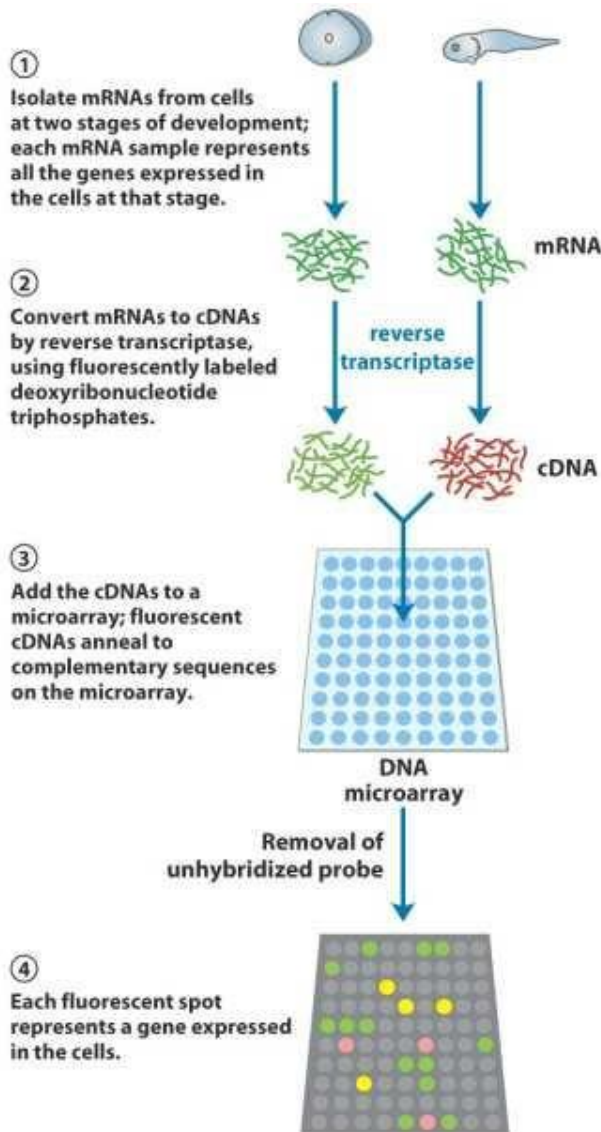

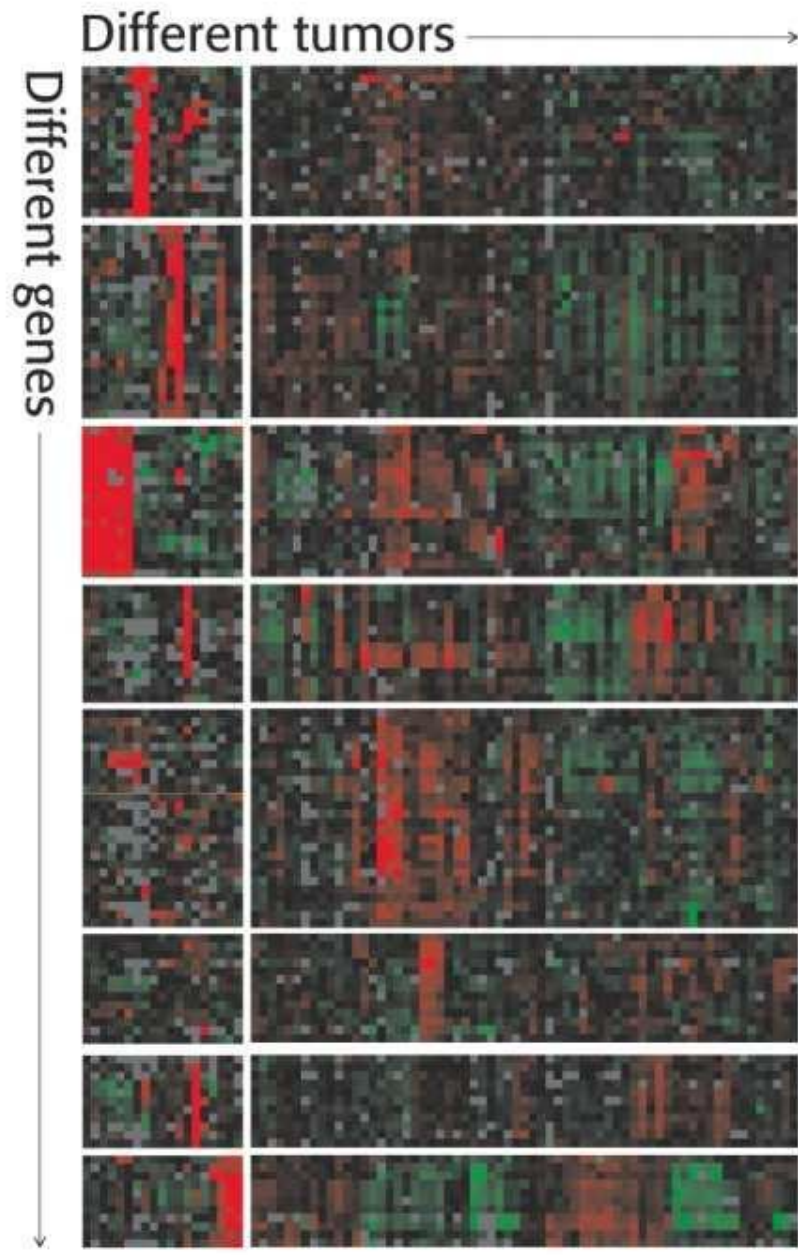

# Studying Transcription

## Primer Extension

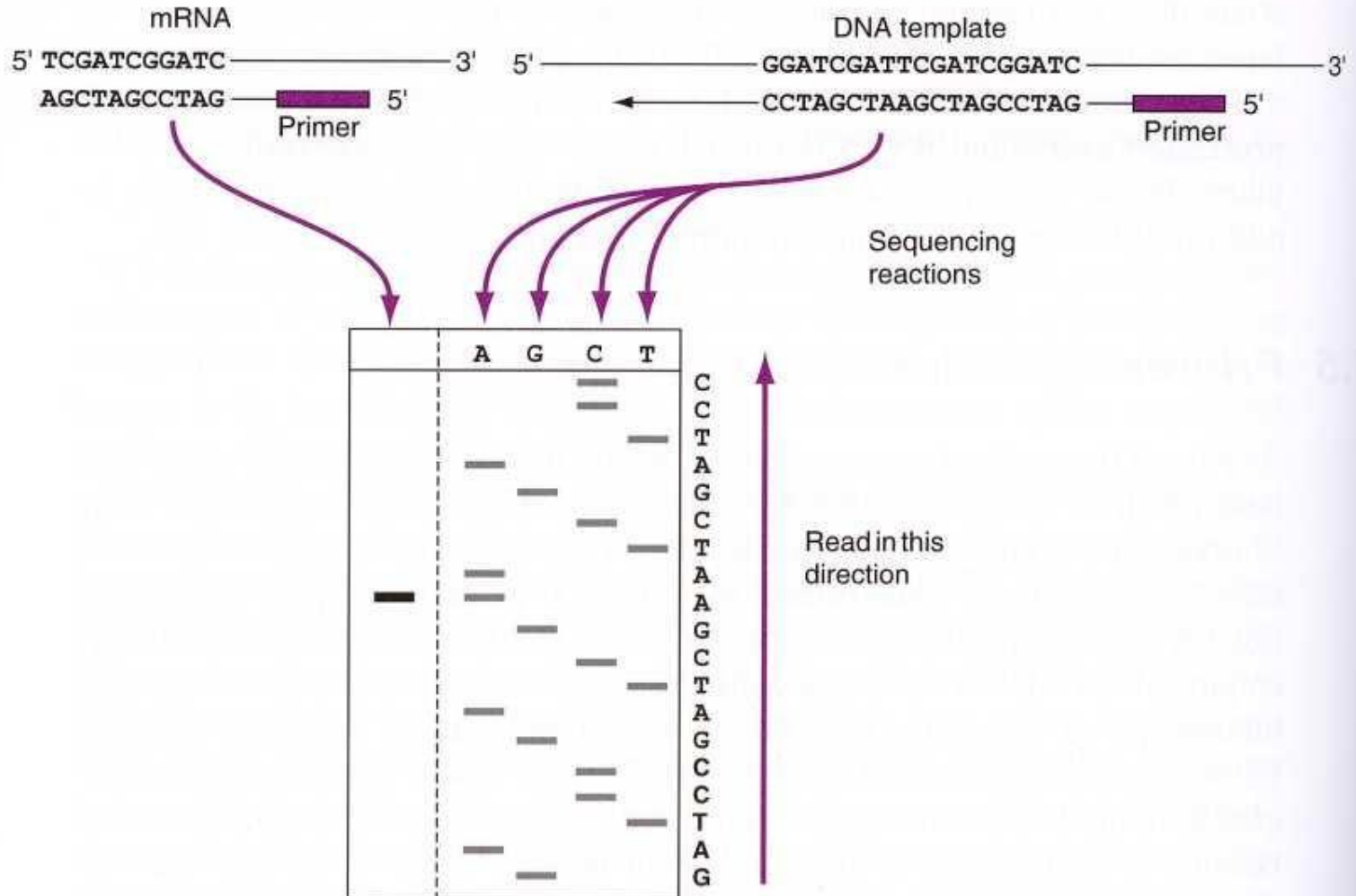

# Promoter Studies

Used reporter genes:

- *Lac Z*
- *GFP*
- *Luciferase*

## (a) Reporter-gene construct

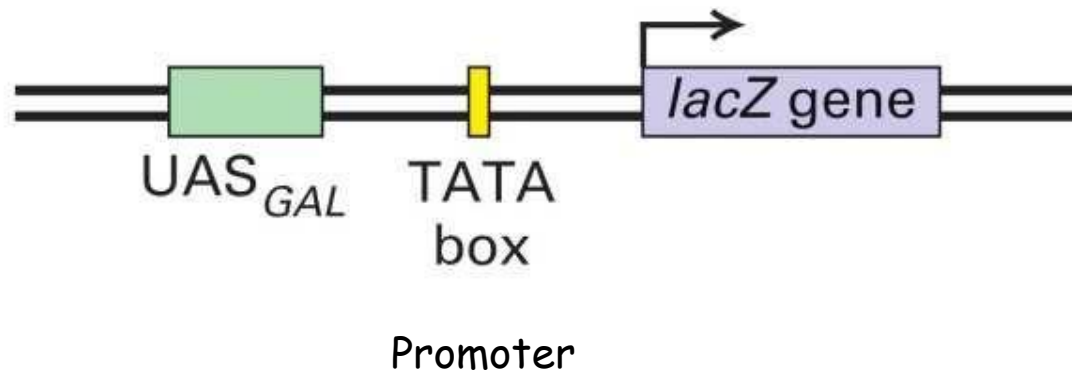

# Promoter studies by using reporter genes

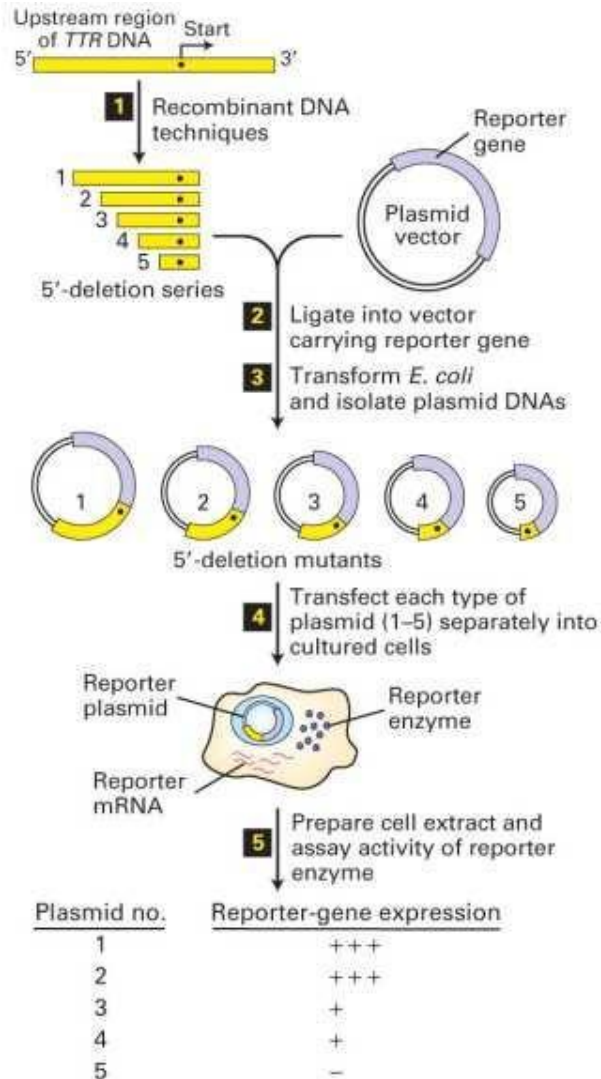



# Luciferase (luc) systems

firefly species *Photinus pyralis*



Expressed luciferase catalyses

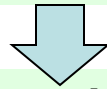

oxidation of compounds called luciferans  
(ATP-dependent process)

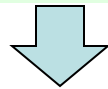

luciferans emit fluorescence



luminometer measurement

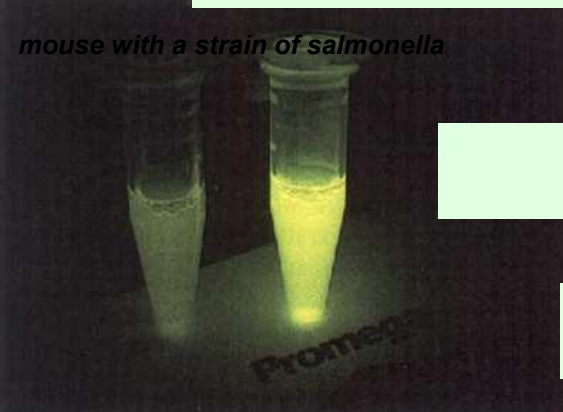
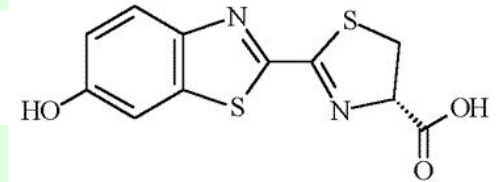

Mice are injected  
with LUC+ salmonellas.  
Sensitive digital cameras  
allow non-invasive detection.  
For GT vectors  
pics look the same

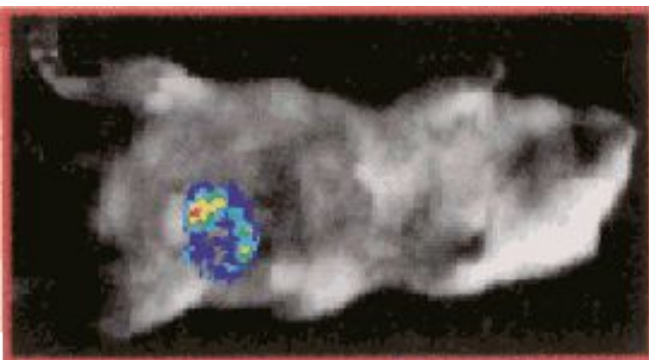



# Green fluorescent protein (GFP)

autofluorescent protein from **Pacific Northwest jellyfish**  
***Aequorea victoria***

GFP is an **extremely stable protein**  
of 238 amino acids with unique **post-translationally created and covalently-attached chromophore** from oxidised residues 65-67,  
**Ser-Tyr-Gly**

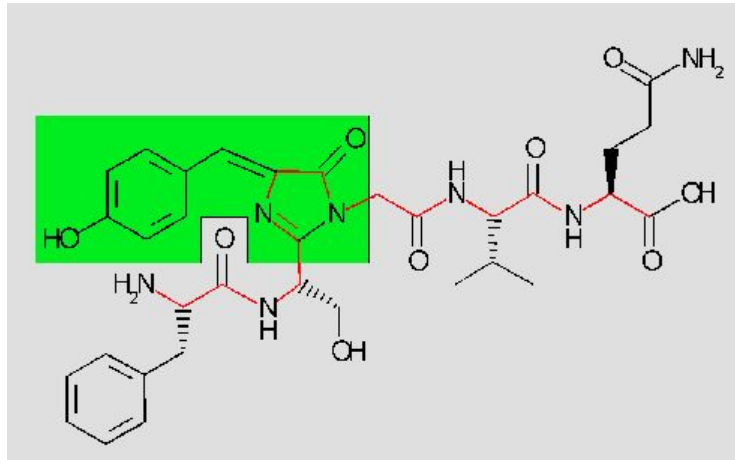

**ultraviolet light causes GFP  
to autofluoresce  
In a bright green color**

**Jellyfish do nothing with UV,  
The activate GFP by aequorin  
(Ca<sup>++</sup> activated,  
bioluminiscent helper)**

***Bioluminescence in Aequorea victoria***



***aequorin***



***green fluorescent protein***

# GFP expression is harmless for cells and animals

White Light



Fluorescent Light

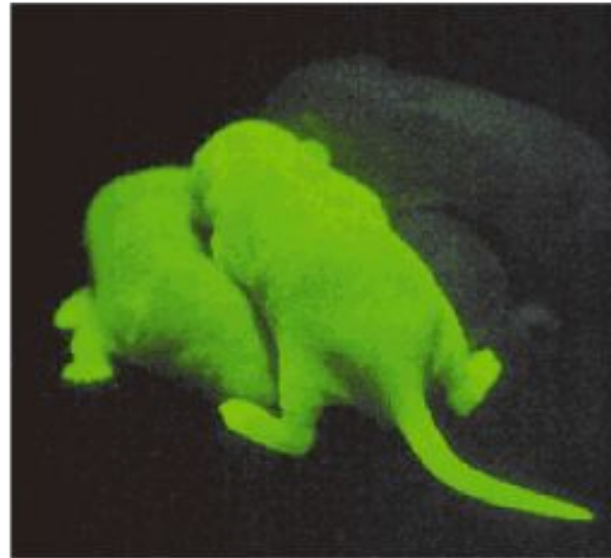

GFP transgenic mice  
from  
Osaka University  
(Masaru Okabe)

**GFP construct could be used for construct tracking in living organism**

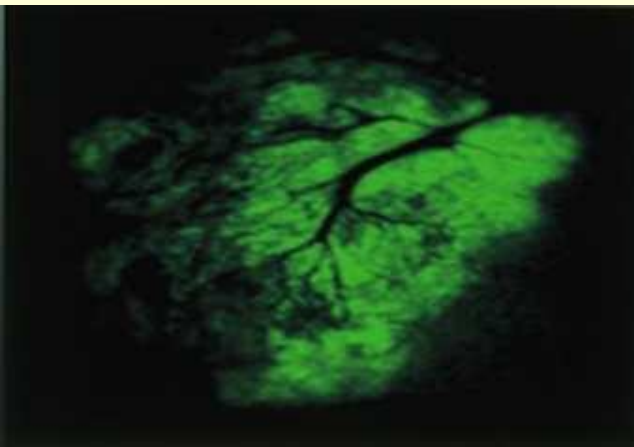

**GFP labelled image of a human tumor.  
Vessel on the tumor surface  
are visible in black**

# Many more fluorescent proteins are engineered

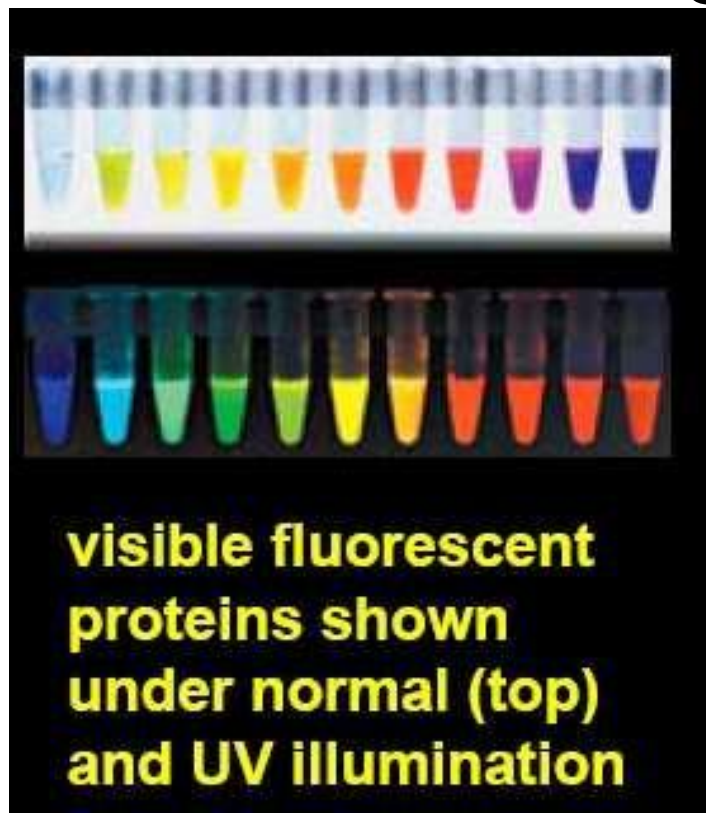

*Chem. & Eng. News, Oct. 25, 2004*

Engineered proteins are covering all the spectrum

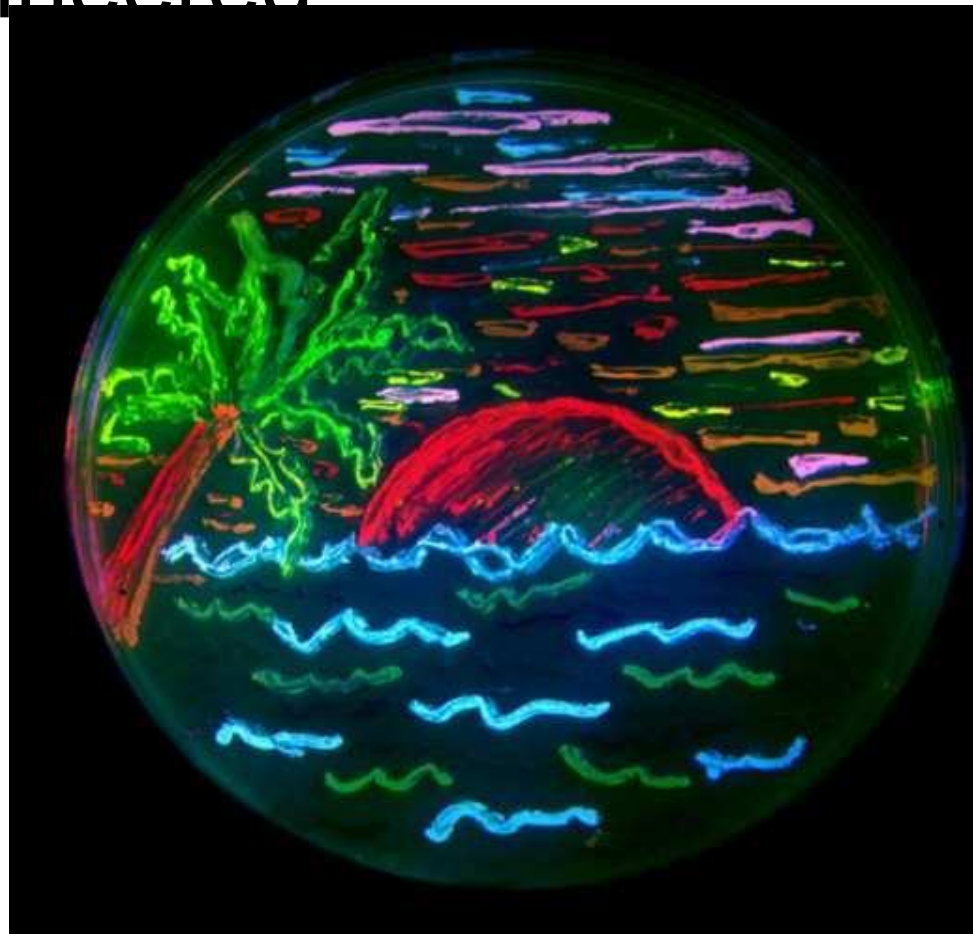

San Diego beach scene drawn with living bacteria expressing 8 different colors of fluorescent proteins.



Use of green fluorescent protein (GFP) as a reporter gene ■

# Analyzing Translation - Western Blot

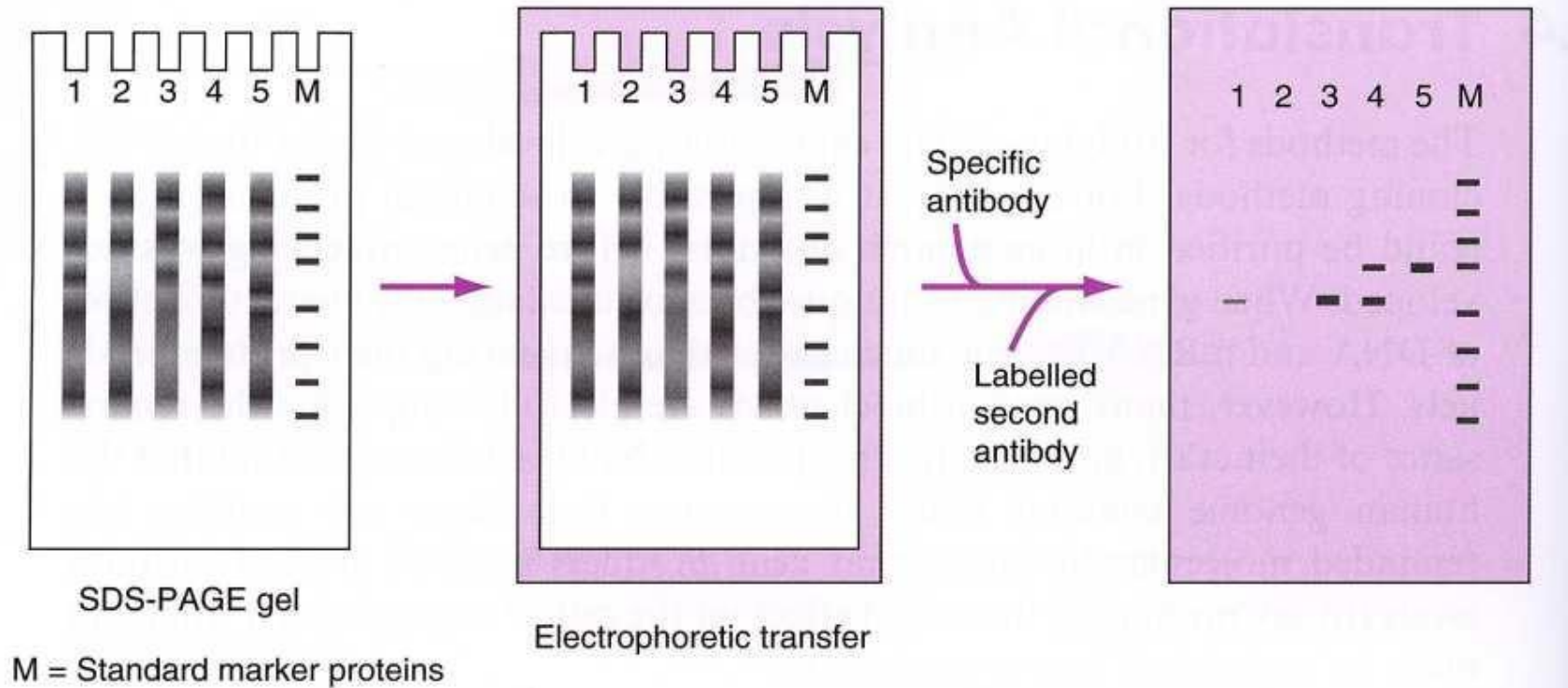



# 2 D Electrophoresis

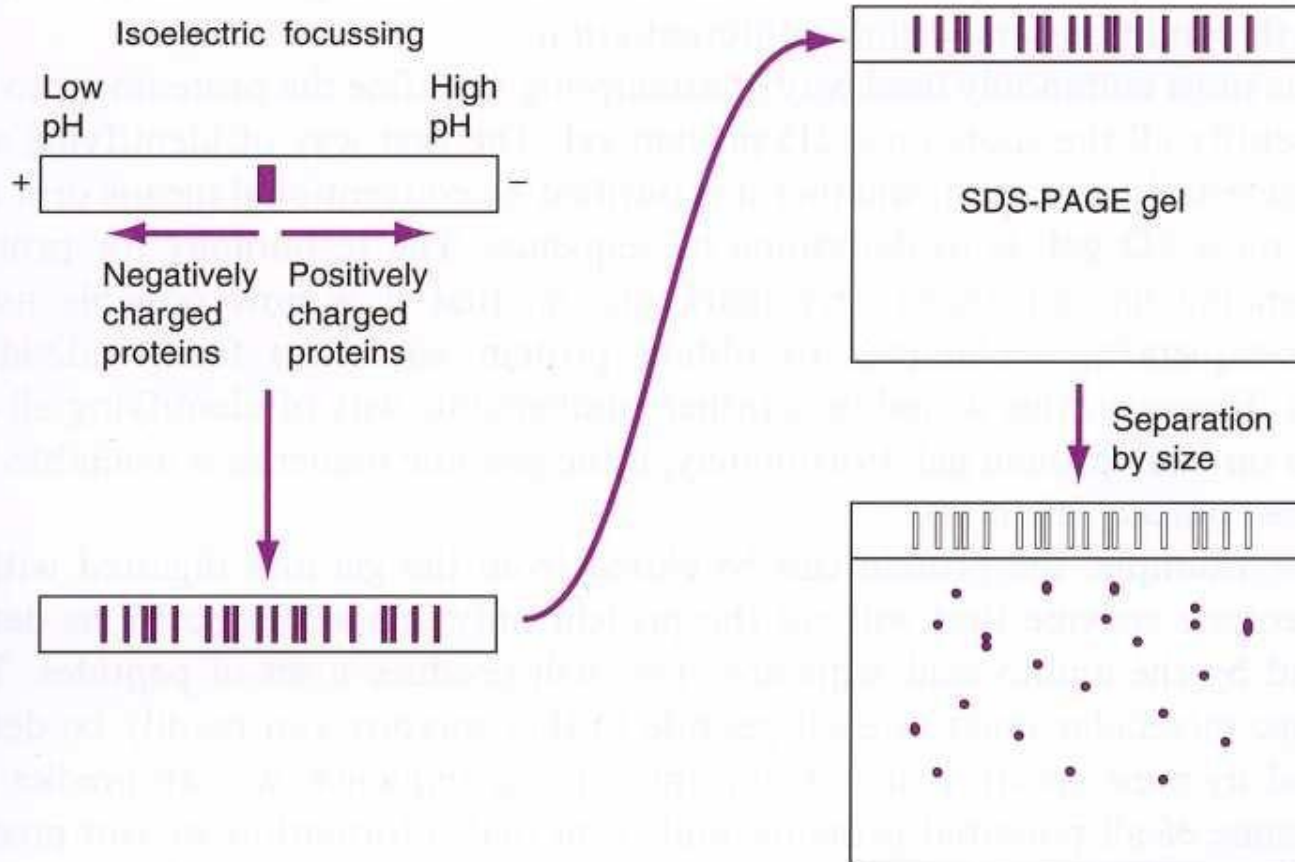

# Gene Expression

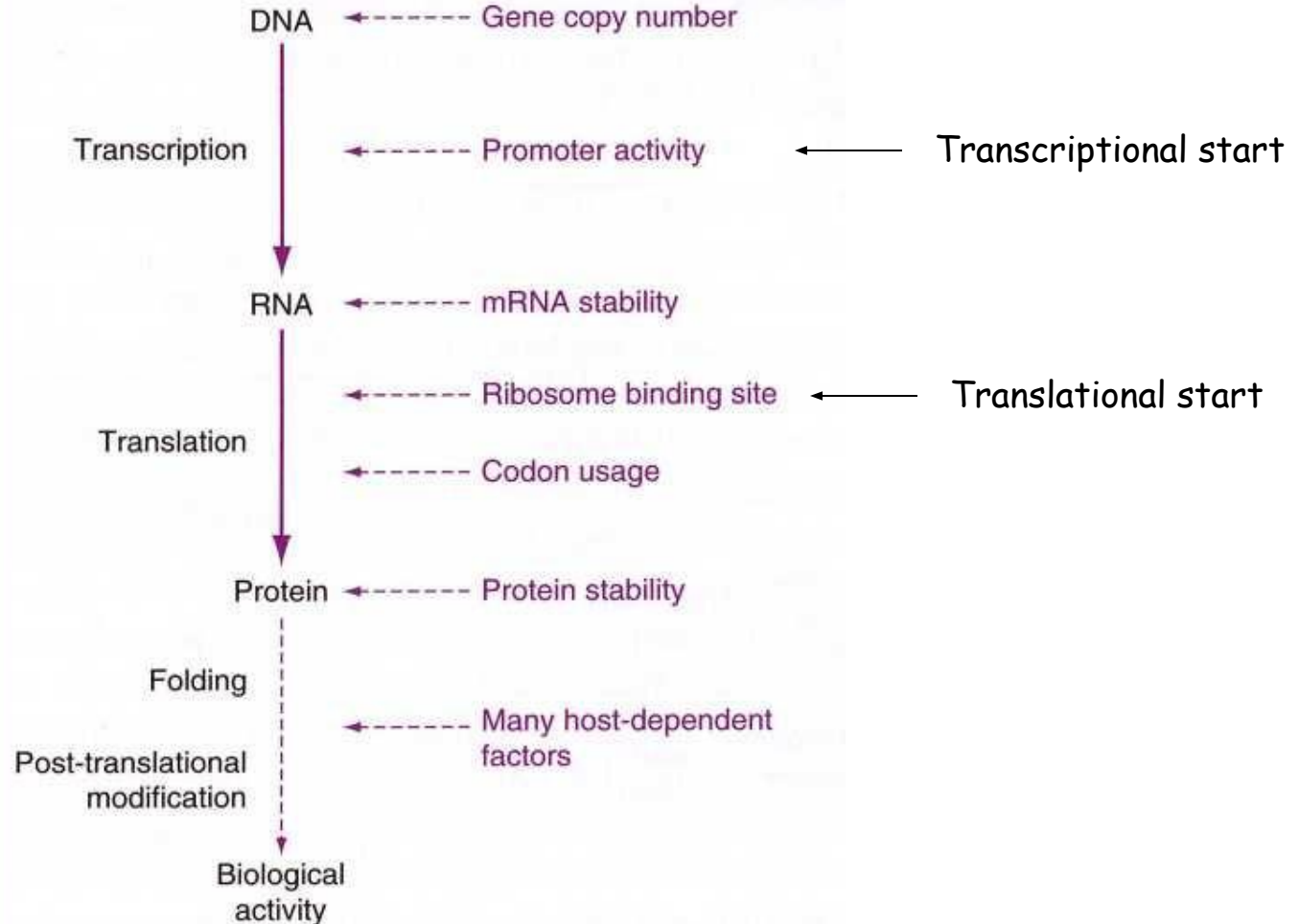



# Gene Expression

## Gene copy number:

### 1. Plasmid copy number:

The copy-number of a plasmid in the cell is determined by regulating the **initiation of plasmid replication**.

The initiation of plasmid replication may be controlled by:

- the amount of available primer (RNA)
- the amount of essential replication proteins
- the function of essential replication proteins.

### 2. Gene dosage -> number of genes integrated into chromosome

- prokaryotic systems -> i.e. Transposons, phages, recombination
- mainly eukaryotic systems

**Table 1. Origins of Replication and Copy Numbers of Various Plasmids and Cosmids**

DNA construct	Origin of replication	Copy number	Classification
<b>Plasmids</b>			
pUC vectors	pMB1 *	500–700	high copy
pBluescript® vectors	ColE1	300–500	high copy
pGEM® vectors	pMB1 *	300–400	high copy
pTZ vectors	pMB1 *	>1000	high copy
pBR322 and derivatives	pMB1 *	15–20	low copy
pACYC and derivatives	p15A	10–12	low copy
pSC101 and derivatives	pSC101	~5	very low copy
<b>Cosmids</b>			
SuperCos	pMB1	10–20	low copy
pWE15	ColE1	10–20	low copy

\* The pMB1 origin of replication is closely related to that of ColE1 and falls in the same incompatibility group. The high-copy plasmids listed here contain mutated versions of this origin.

### Incompatibility of plasmids:

Not all plasmids are able to coexist in the same cell.

Plasmids which have the same replication control functions are incompatible, and are assigned to the same incompatibility group (inc group).

Plasmids of one incompatibility group are related to each other, but cannot survive together in the same bacterial cell, as only different kinds of plasmids are compatible.

Ensures that we can make libraries -> just one plasmid taken up by one cell

# Homologous integration into chromosome

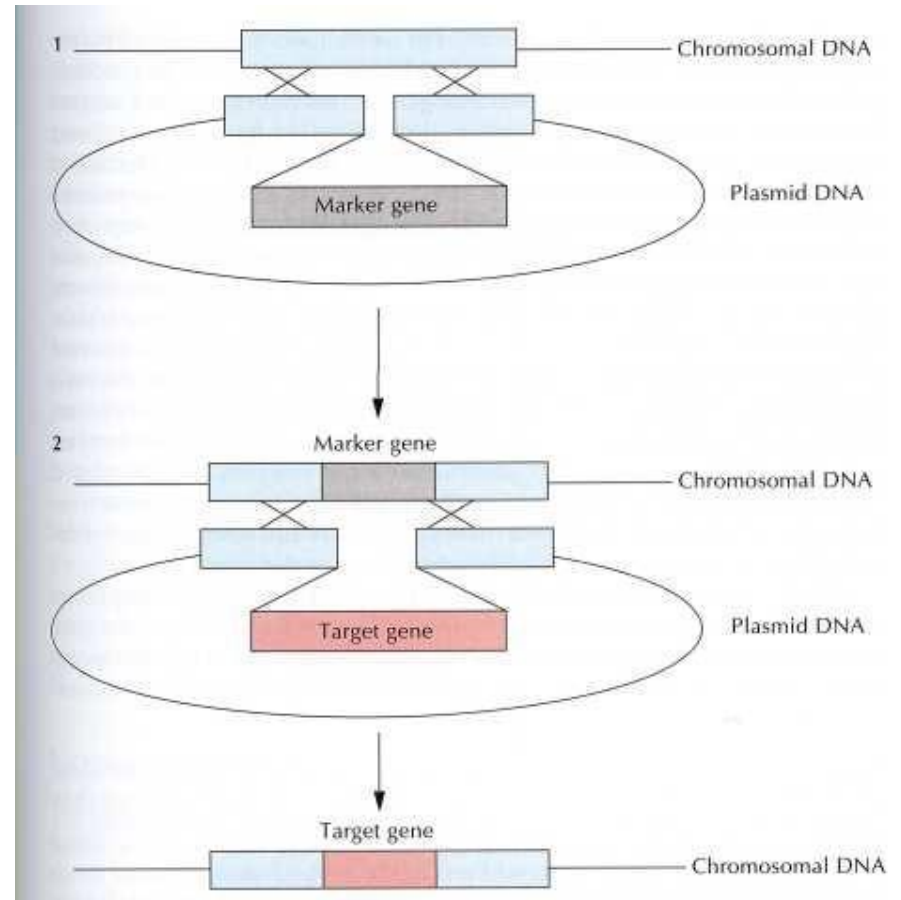
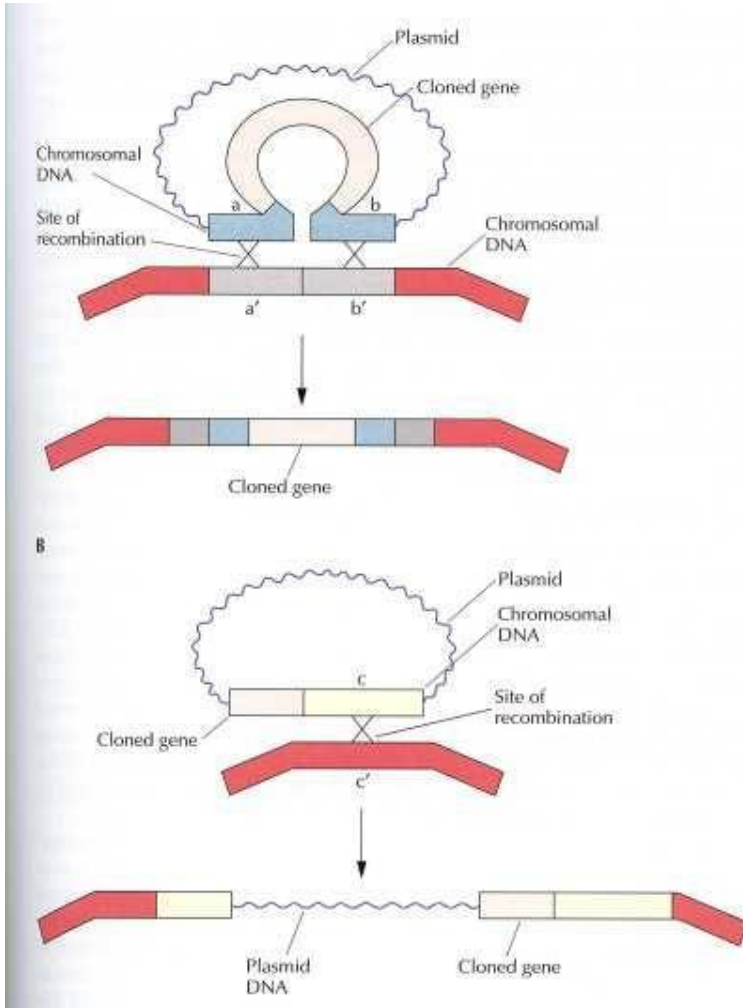

Insertion on *Bacillus subtilis* chromosome

# Protein expression in prokaryotic systems

Vector preparation



Transformation



Induction

Screening & selecting

Protein Expression

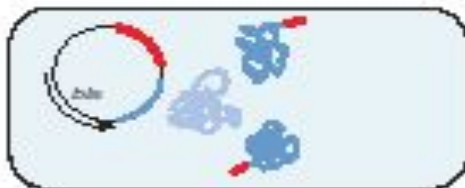

So, this new story would be about vectors again.

**Bacterial expression vectors have some distinct features:**

Inducible promoter systems;

Protein fusions including fused tags;

# General advices for one who wants to produce gene expression in prokaryotes

**Most obvious and common mistakes:**

**1. Do not forget to cut out the intron**

**2. Check orientation of insert**

**3. Do fusions with something In-frame**

**4. No Post-translation modification  
= no product activity**

# Introns

Not an issue  
when you clone a cDNA

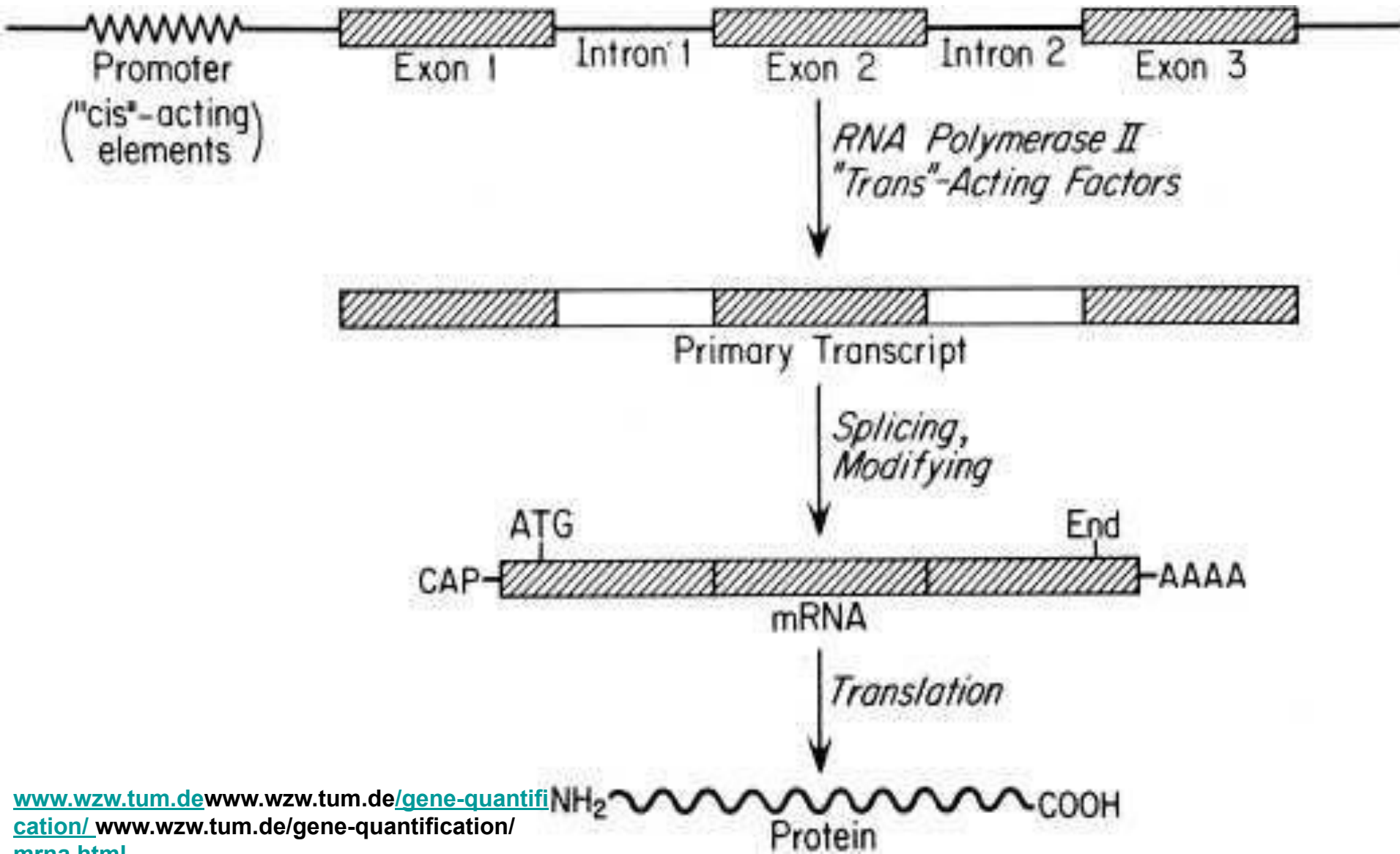

# Orientation of insert

(could go backward, if cloned with same-type sticky ends) – use incompatible sticky ends

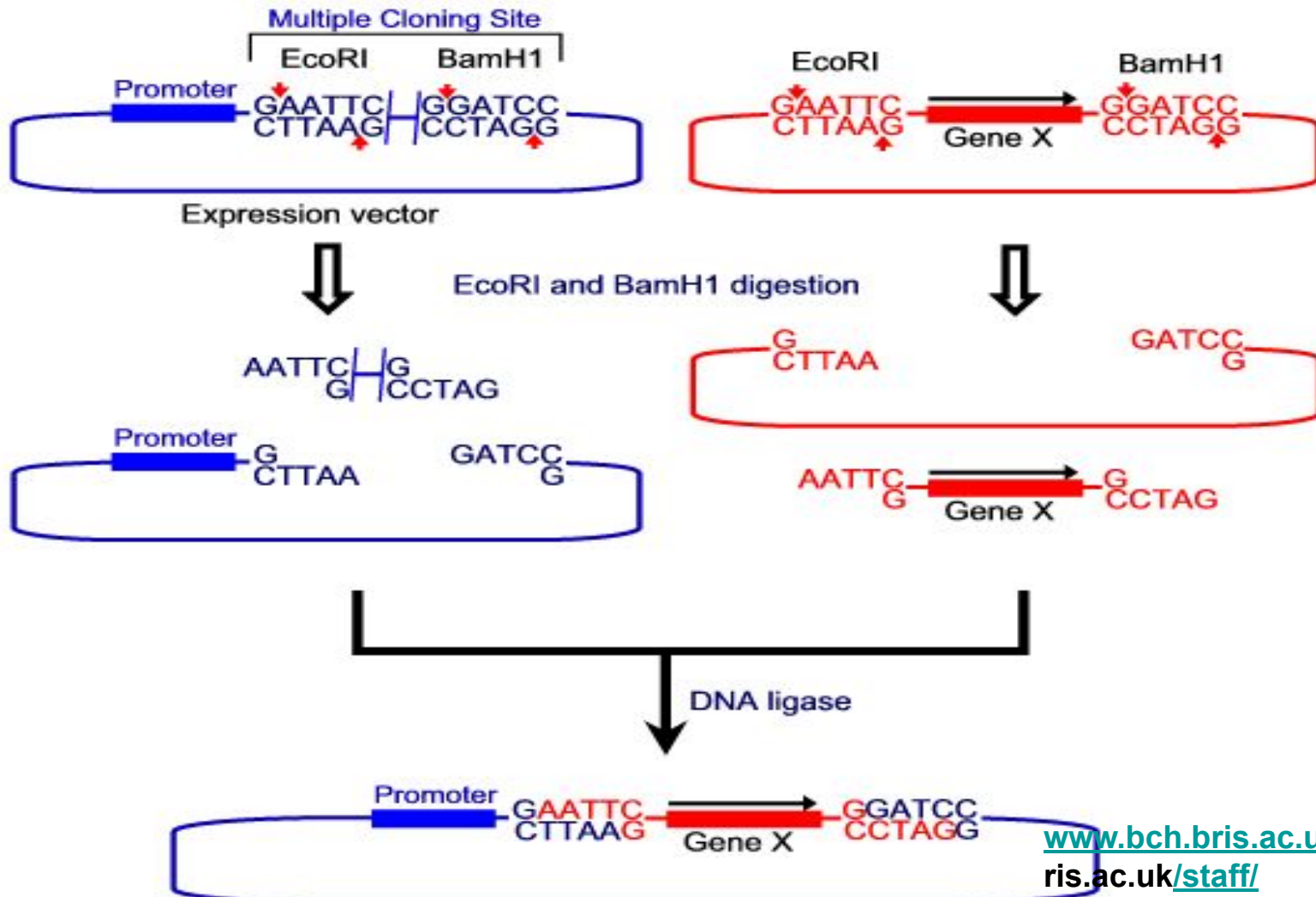

Gene X can only be inserted in the correct direction due to incompatible sticky ends.



# Fusion proteins.

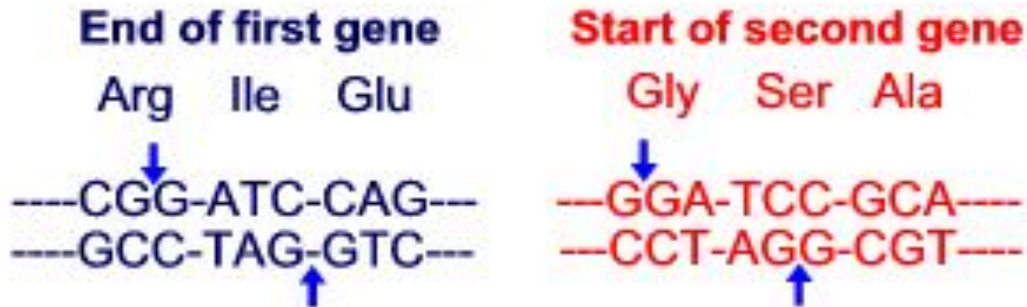

↓ BamH1 digestion



↓ Ligation (DNA ligase)



The second gene is not in the same reading frame as the first and is incorrectly expressed.

When expressing a fusion proteins, ensure that both of them are in the same reading frame

# PostTranslational modification

Eukaryotic cells have Golgi system

Prokaryotic cells do not have it

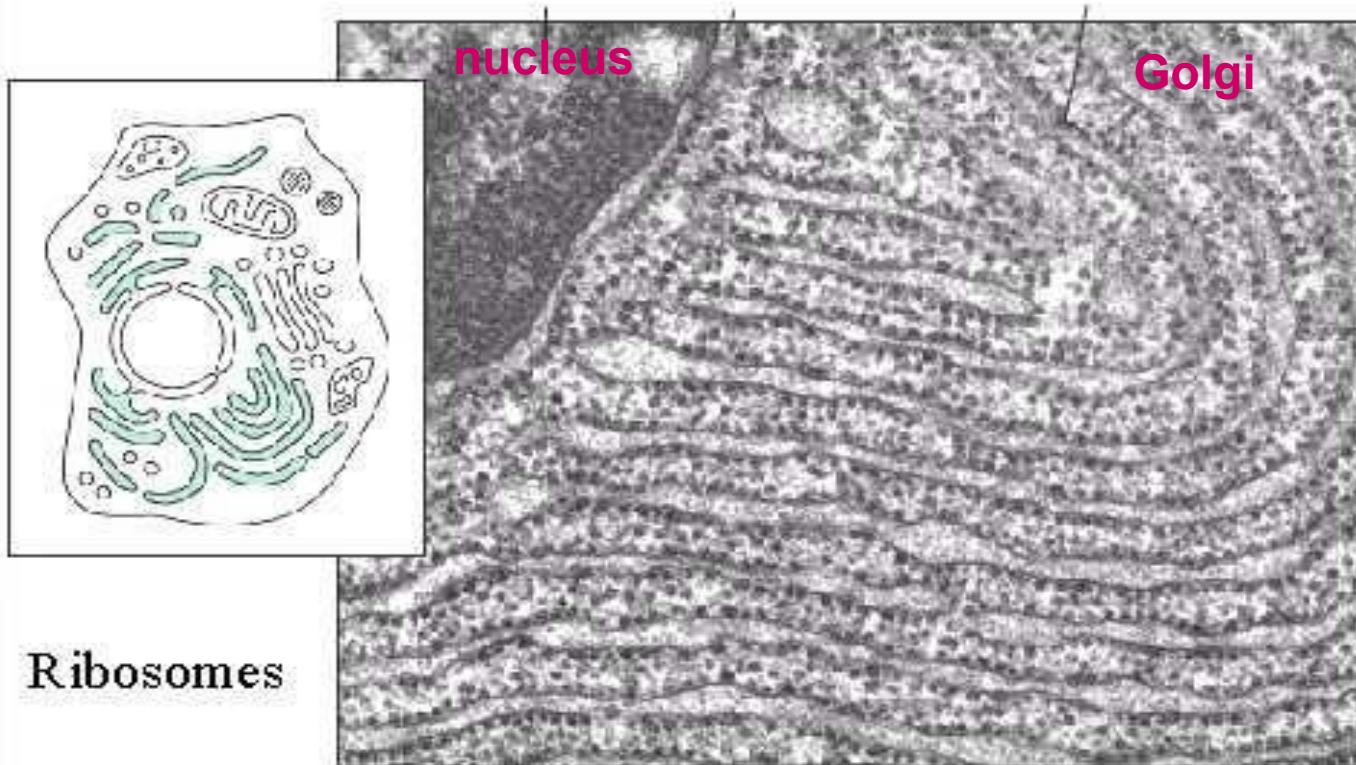

Synthesis of secreted and membrane proteins

# Efficiency of expression in E.coli

## Dependent of:

1. Type of transcription promoter and terminator
2. Affinity of mRNA and prokaryotic ribosome
3. Amount of copies of transgene and its localization (chromosome or plasmid)
4. Cellular localisation of the protein end-product
5. Efficiency of translation in the host organism
6. Stability of protein product in the host organism

**Systems could be optimized on gene to gene basis.**

**No universal strategy possible**

# Factors affecting transcription

**1. Promoters** (including regulated ones)  
**PROKARYOTIC!!!!**

**2. Terminators**  
**PROKARYOTIC!!!!**

# Variations between prokaryotic promoters are minimal

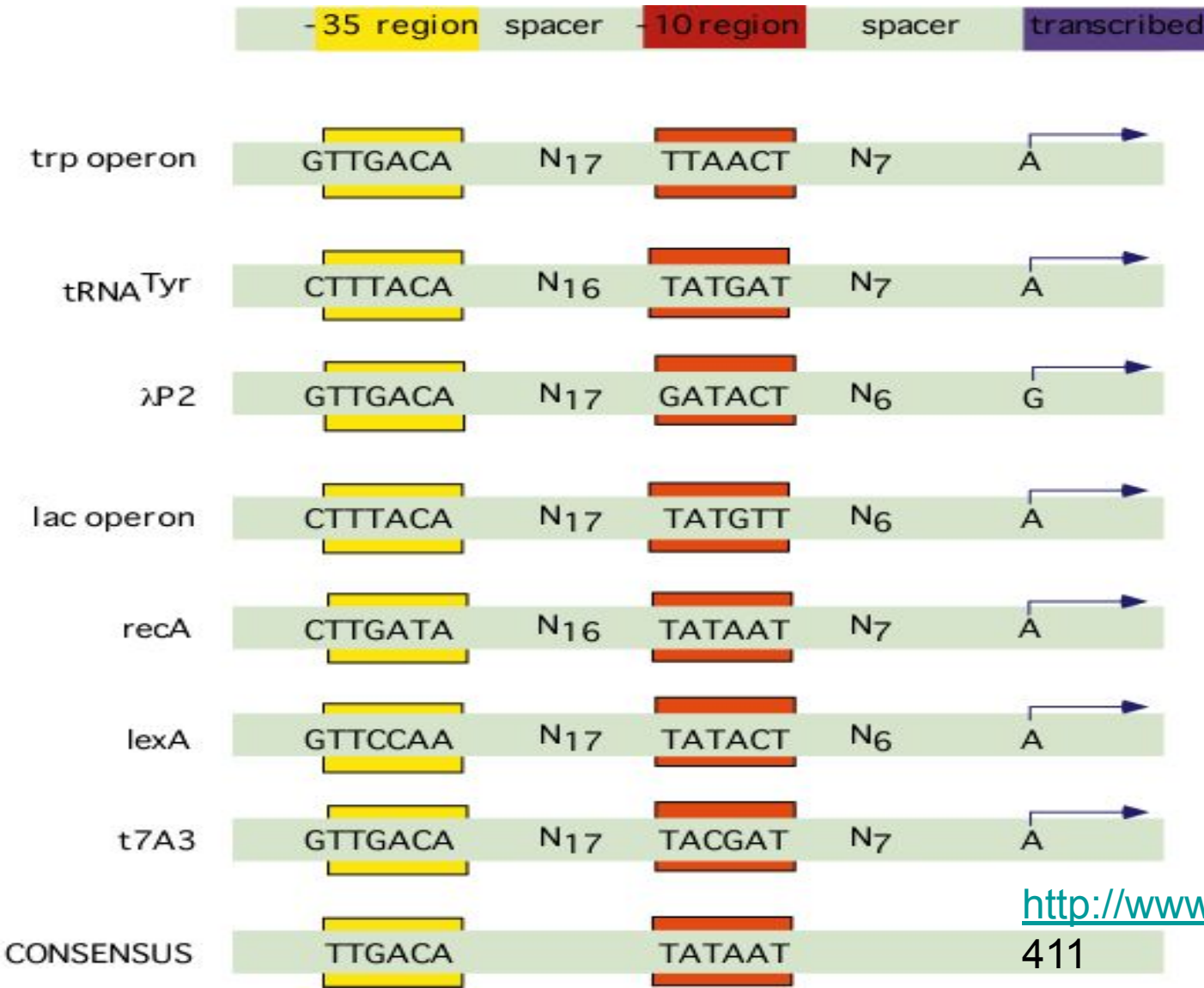

# Factors affecting translation

**1. Ribosome binding site (RBS)**

**2. Codon bias**

**3. Stability of the transcript**

# Ribosome binding site (RBS) = translation initiation site complimentary to 16S rRNA

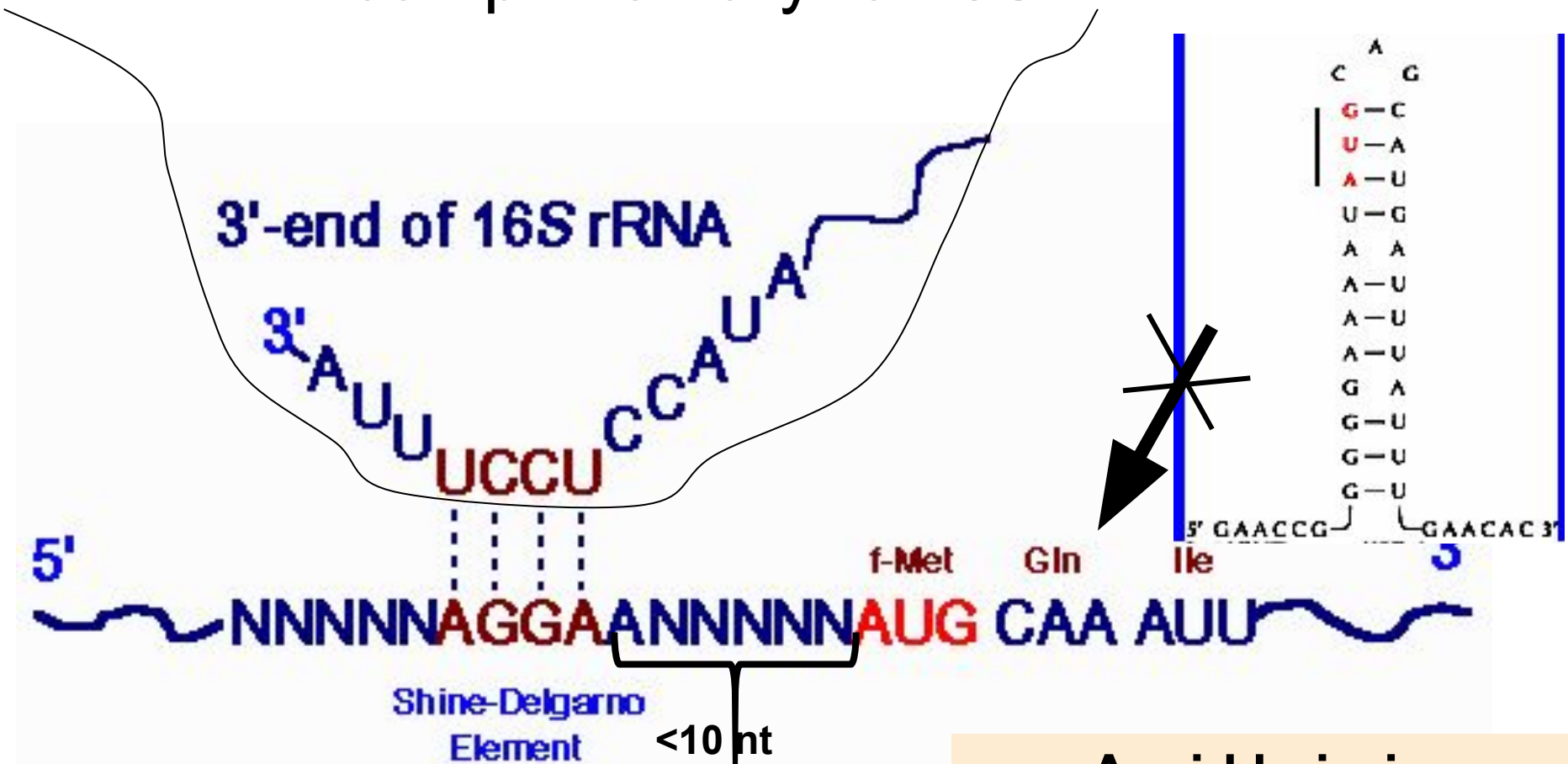

Examining the second codon;  
better AAA – lysin (13.9% of all E.coli genes).  
Expression can vary 15 times.

Avoid hairpins  
on 5' end of gene  
(minimize GC content)



# Codon Usage in *E. coli* & humans

Codon	Amino acid	Frequency of use in:	
		<i>E. coli</i>	Humans
GAG	Glutamic acid	0.30	0.59
GAA	Glutamic acid	0.70	0.41
CGG	Arginine	0.08	0.19
CGA	Arginine	0.05	0.10
CGU	Arginine	0.42	0.09
CGC	Arginine	0.37	0.19
AGG	Arginine	0.03	0.22
AGA	Arginine	0.04	0.21
CCG	Proline	0.55	0.11
CCA	Proline	0.20	0.27
CCU	Proline	0.16	0.29
CCC	Proline	0.10	0.33
UGA	Stop	0.30	0.61
UAG	Stop	0.09	0.17
UAA	Stop	0.62	0.22

# Codon Optimization Strategies

---

- **Chemically synthesize new gene**
  - Alter sequence of the gene of interest to match donor codons to the codons most frequently used in host organism
- **Express in different host**
  - choose host with better matching codon usage
- **Use an engineered host cell**  
that overexpresses low abundance tRNAs

# Commercial *E. coli* strains encode for a number of the rare codon genes

**BL21 (DE3) CodonPlus-RIL  
(AT-rich compatible)**

arginine (**AGG, AGA**),  
isoleucine (**AUA**) and leucine (**CUA**)

**BL21 (DE3) CodonPlus-RP  
(GC-rich compatible)**

arginine (**AGG, AGA**)  
and proline (**CCC**)

**(AT-rich compatible)  
Rosetta or Rosetta (DE3)**

**AGG/AGA** (arginine),  
**CGG** (arginine), **AUA** (isoleucine)  
**CUA** (leucine) **CCC** (proline), and **GGA** (glycine)

# Mitochondria and chloroplast genes

## Alterations in the Standard Genetic Code in Mitochondria

### Mitochondria

CODON	Standard Code: Nuclear-En coded Proteins	Mammals	<i>Drosophila</i>	<i>Neurospora</i>	Yeasts	Plants
UGA	Stop	Trp	Trp	Trp	Trp	Stop
AGA, AGG	Arg	Stop	Ser	Arg	Arg	Arg
AUA	Ile	Met	Met	Ile	Met	Ile
AUU	Ile	Met	Met	Met	Met	Ile
CUU, CUC, CUA, CUG	Leu	Leu	Leu	Leu	Thr	Leu

# Factors affecting protein stability

**1. Overall level of protease activity  
in bacterial cells**

**2. N-terminal amino acid affects protein  
half-life**

**3. Internal regions containing clusters of certain amino acids  
can increase proteolysis**

**P** proline

**E** glutamic acid

**S** serine

**T** threonine

.... Mutate PEST aminoacids....

# Protease-deficient host strains

BL21, the work horse of *E. coli* expression, is deficient in two proteases encoded by the *lon* (cytoplasmic) and *ompT* (periplasmic) genes.

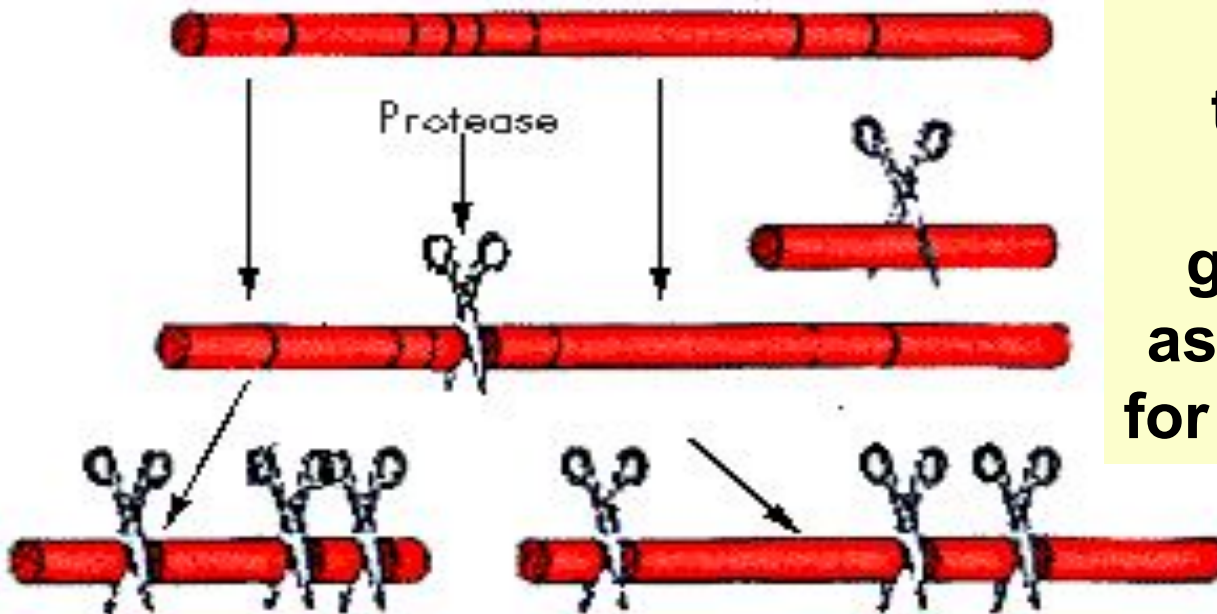

It is dangerous to kill proteases, it makes E.coli grow much slowly as proteases needed for proper metabolism

# Inducible bacterial promoters

Why not to use constitutive, always strong promoter?



Because recombinant (alien) protein is often **toxic** for bacterial cell.

Bacteria tend to expel harmful plasmids



Induction



# BL(DE3) inducible system and pET vectors (invented in 1984 by Bill Studier, on sale by Novagen)

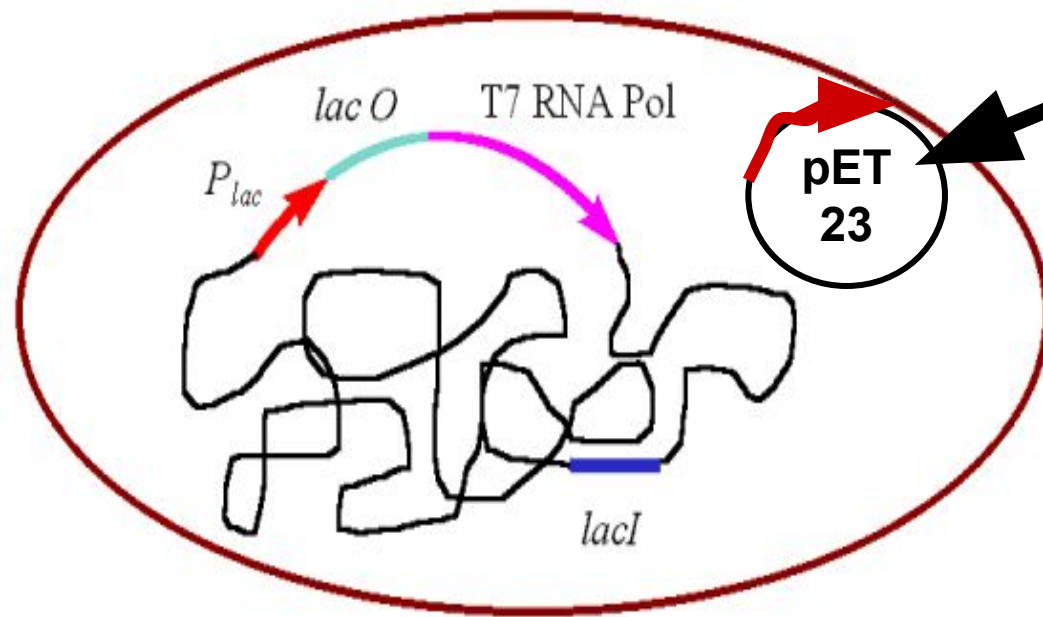

Gene of interest  
is expressed from  
strong T7 promoter

BL(DE3) Host Chromosome

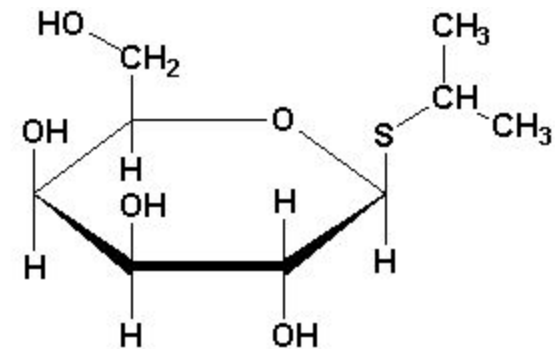

Isopropyl Thiogalactoside (IPTG)

- 1) T7 RNA polymerase gene is integrated in chromosome under the control of a *lac* promoter and operator
- 2) lactose analogue, IPTG, causes the host to produce T7 RNA polymerase
- 3) The *E. coli* host genome also carries the *lacI* (repressor) gene

# Why repressor gene and gene of interest are expressed from different DNA molecules?

**Repressor gene** expressed from **chromosome**;  
**Gene of Interest** expressed from **plasmid**

If too **high repressor**  **no transcription**  
(you need to increase expensive IPTG)

If too **low repressor**  **promoter is leaky**  
(active without IPTG)

**Repressor is in chromosome,  
because there it is best kept controlled there  
(no plasmid loss, not too high expression)**

# Where your expressed protein will be located?

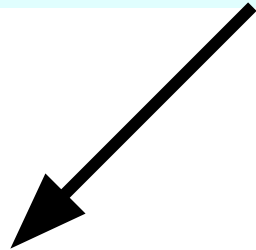

**Inclusion bodies  
(insoluble)**

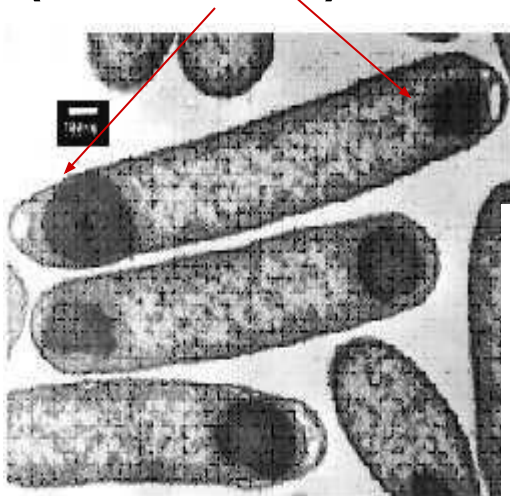

**Cytoplasm  
(soluble)**

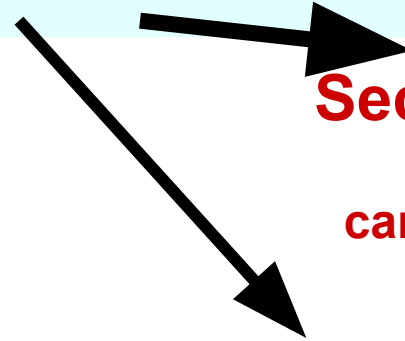
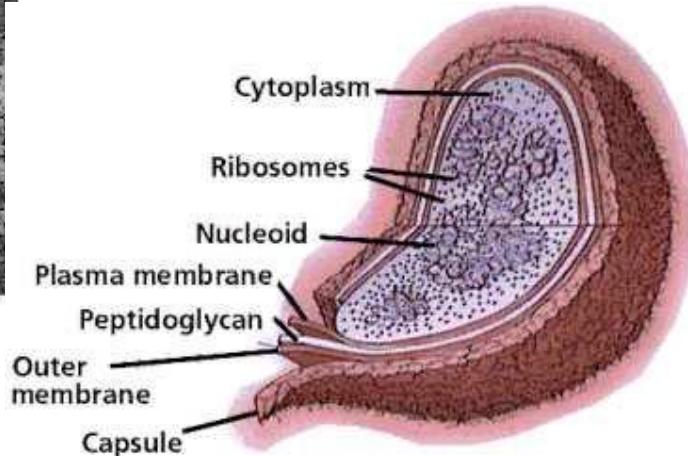

**Periplasmic space  
(soluble or insoluble)**

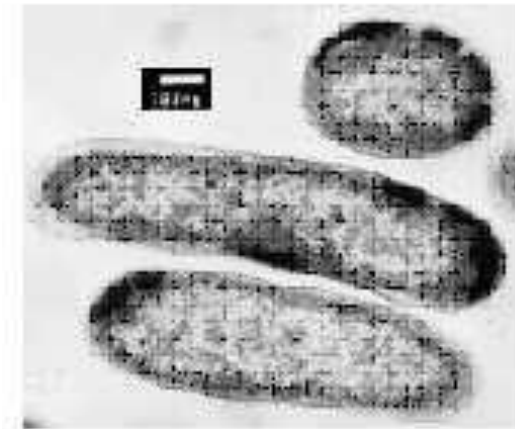

**Secreted (!!)**  
E.Coli  
can not do that

# 1. Inclusion bodies (most common case)

-- Inclusion bodies are formed through the **accumulation of folding intermediates** rather than from the native or unfolded proteins.

-- It is **not possible to predict** which proteins will be produced as inclusion bodies.



-- Production of inclusion bodies **not dependent on the origin of protein, the used promoters, the hydrophobicity of target proteins...**

# Protein Folding



Electron micrograph of an inclusion body of the protein prochymosin in an *E. coli* cell

# Good side of inclusion bodies

1) inclusion bodies can be **accumulated in the cytoplasm to much higher level** (greater than 25%) than production as soluble form;

2) inclusion bodies is initially isolated in a highly purified, solid, and concentrated state by **simple physical operation (centrifugation)**.

3) inclusion bodies have **no biological activity**. For toxic proteins it may be the only one available;

4) inclusion bodies are **resistant to proteolysis** That results in the high yield of protein production.

# SDS-PAGE analysis of recombinant protein produced as inclusion body

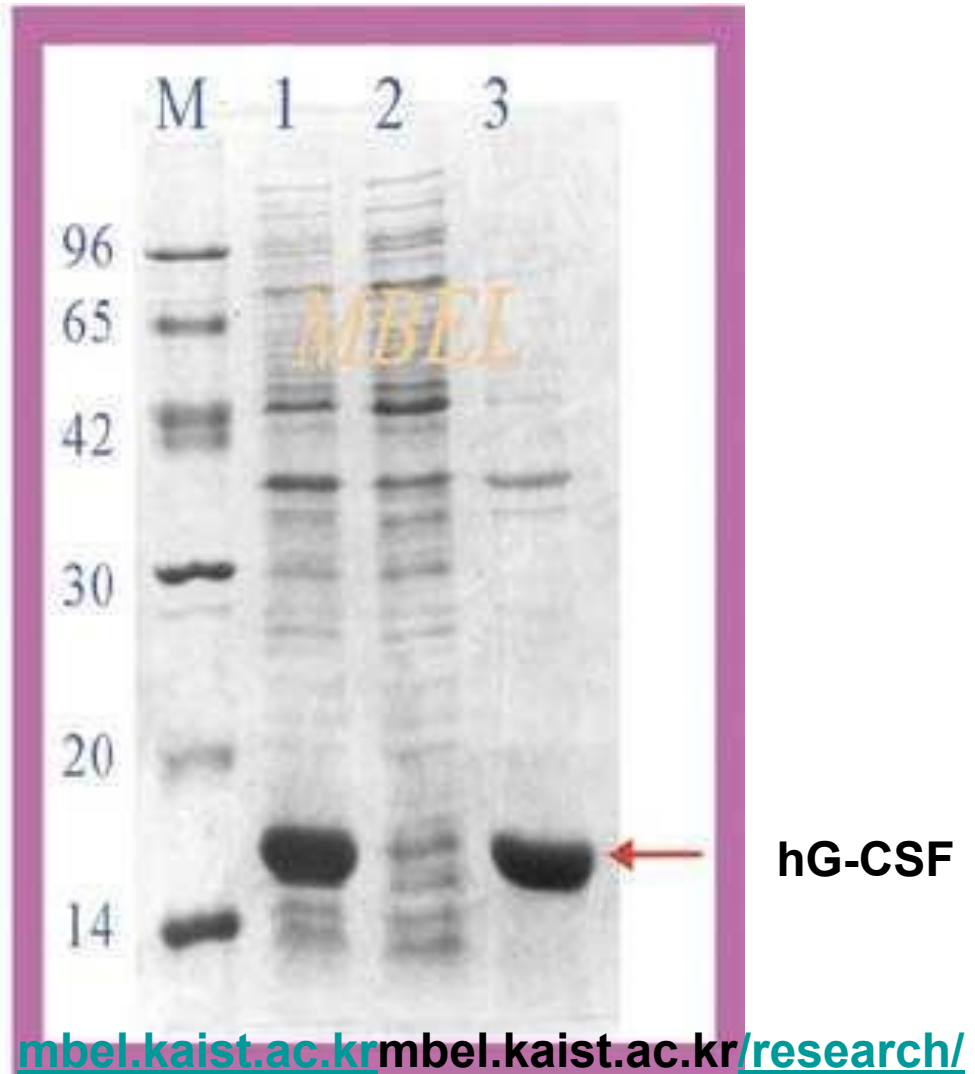
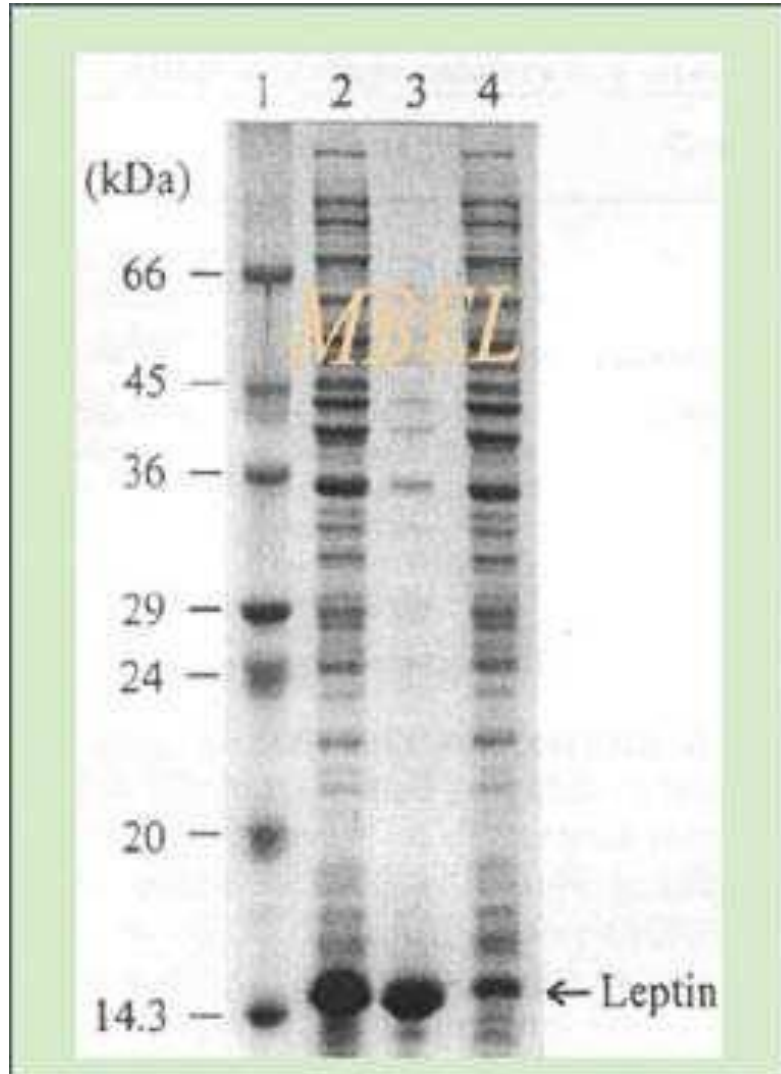

# Recovery of proteins from inclusion bodies

Is not a straightforward process, but road of trials and errors

## Solubilization

## Refolding

Choice of **solubilizing agents**,  
e.g., **urea**,  
**guanidine HCl**,  
**or detergents**,  
plays a key role  
in solubilization  
efficiency

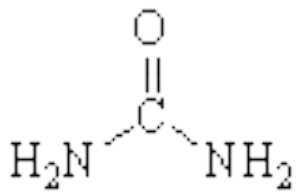

Urea

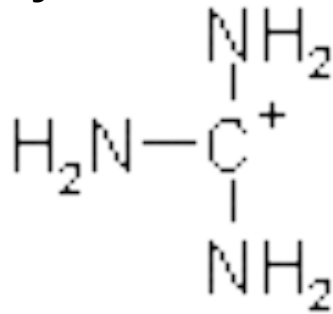

Guanidinium

-- Refolding is initiated  
by **reducing concentration**  
of denaturant used to solubilize IBs.

-- Refolding **competes with** other reactions,  
such as **misfolding and aggregation**  
(both are leading to bad results)

-- **Chaperones** are helpful in refolding  
(including chemical chaperones)



# Question of questions – how to purify your protein?

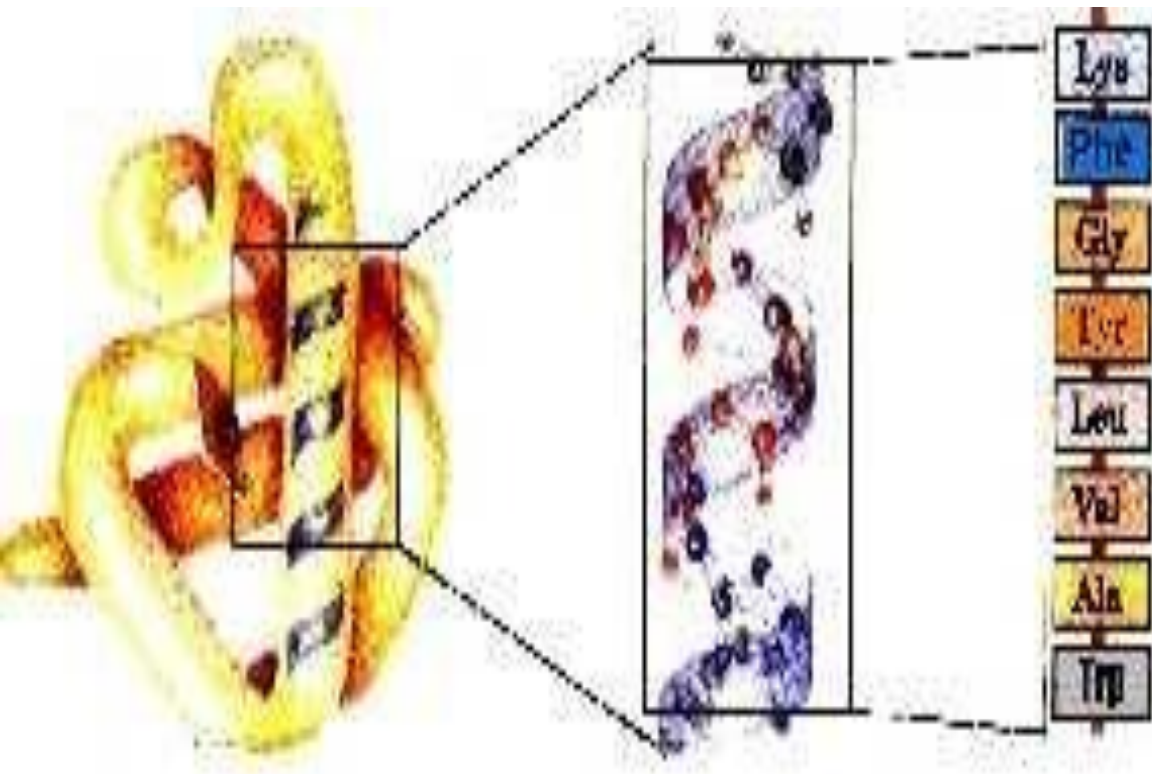

# Diversity of proteins could be exploited

## PROTEIN SEPARATION



Proteins are very diverse. They differ by size, shape, charge, hydrophobicity, and their affinity for other molecules. All these properties can be exploited to separate them from one another so that they can be studied individually.

## Column chromatography

Matrix particles usually packed in the column in the form of small beads.

A protein purification strategy might employ in turn each of the three kinds of matrix described below,

with a final protein purification Of up to 10,000-fold.

# Column chromatography

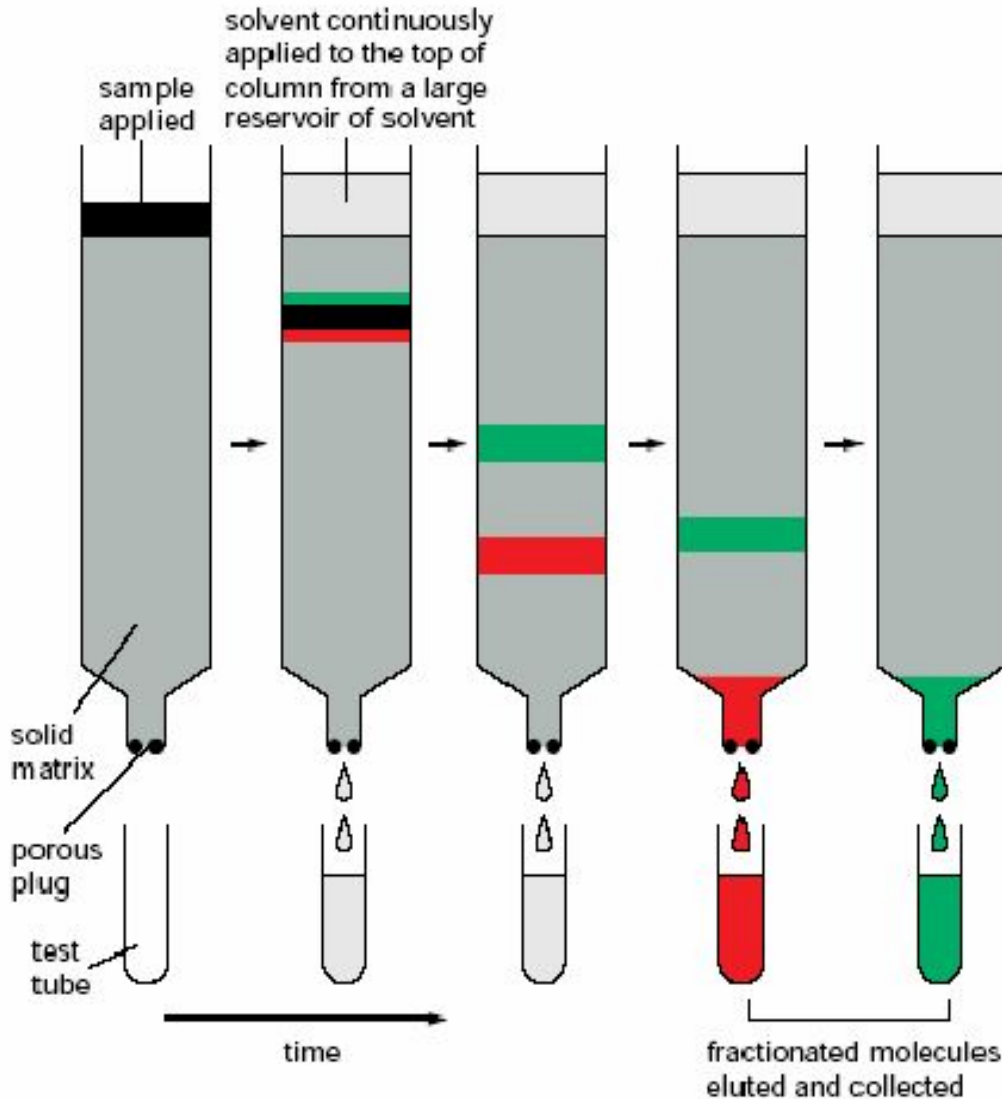

**Different proteins are retarded to different extents by their interaction with the matrix, they can be collected separately as they flow out from the bottom.**

**According to the choice of matrix, proteins can be separated according to**

- their charge,
- their hydrophobicity,
- their size,
- their ability to bind to particular chemical groups (!!)

# (A) ION-EXCHANGE CHROMATOGRAPHY

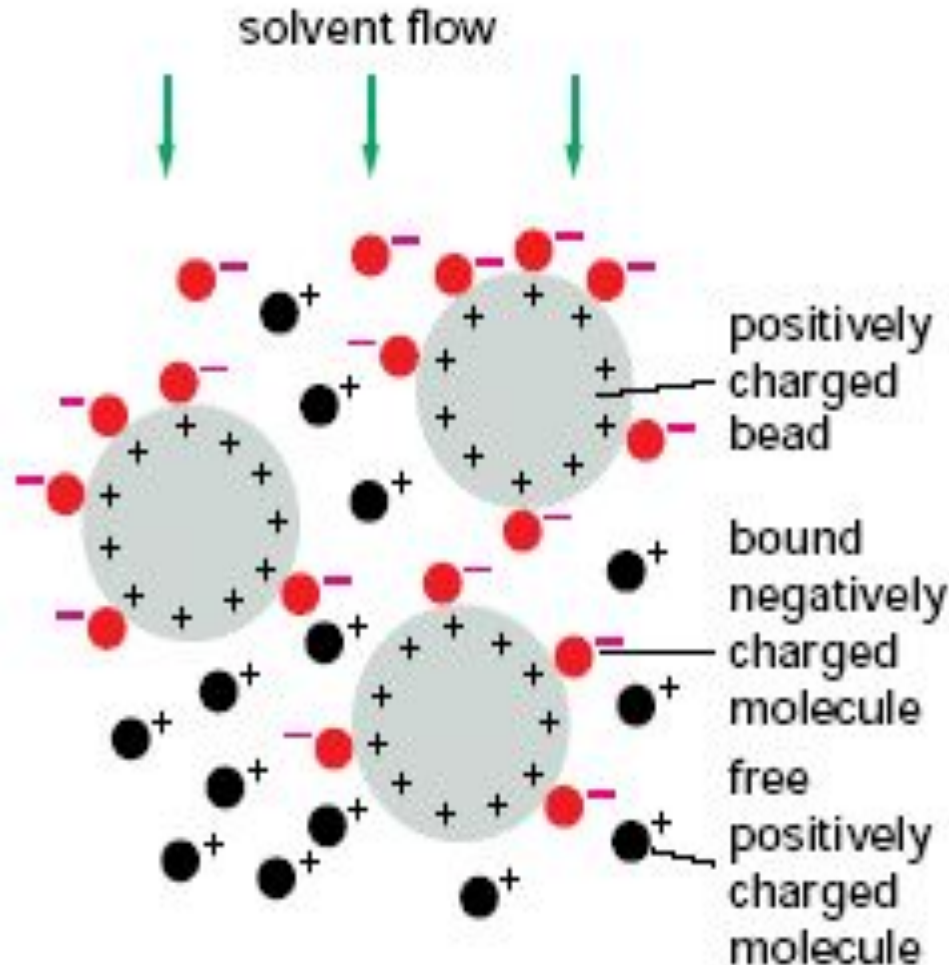

**Ion-exchange columns** are packed with **small beads** that carry **positive or negative charges** retarding proteins of the opposite charge.

The **association** between a protein and the matrix **depends on the pH** and **ionic strength of the solution** passing down the column.

These can be varied in a controlled way to achieve an effective separation.

# (B) GEL-FILTRATION CHROMATOGRAPHY

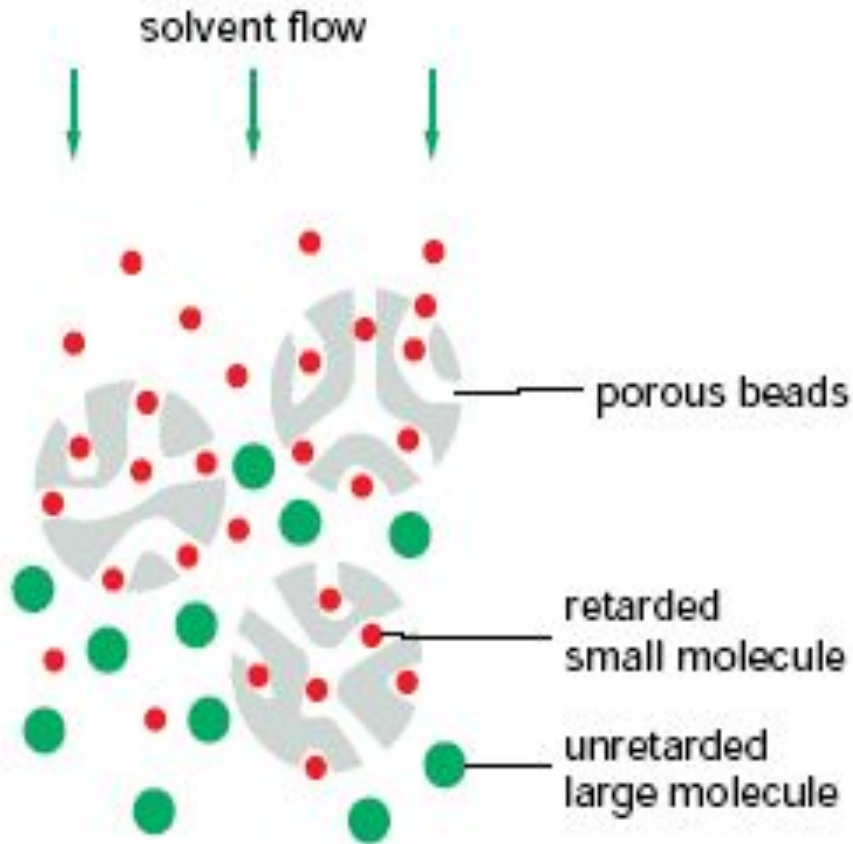

**Gel-filtration columns** separate proteins according to their size on tiny porous beads.

Protein molecules that are **small enough** to enter the holes in the beads **are delayed** and travel more slowly through the column.

Proteins that **cannot enter** the beads are **washed out** of the column first.

Such columns also **allow an estimate of protein size.**



# (C) AFFINITY CHROMATOGRAPHY

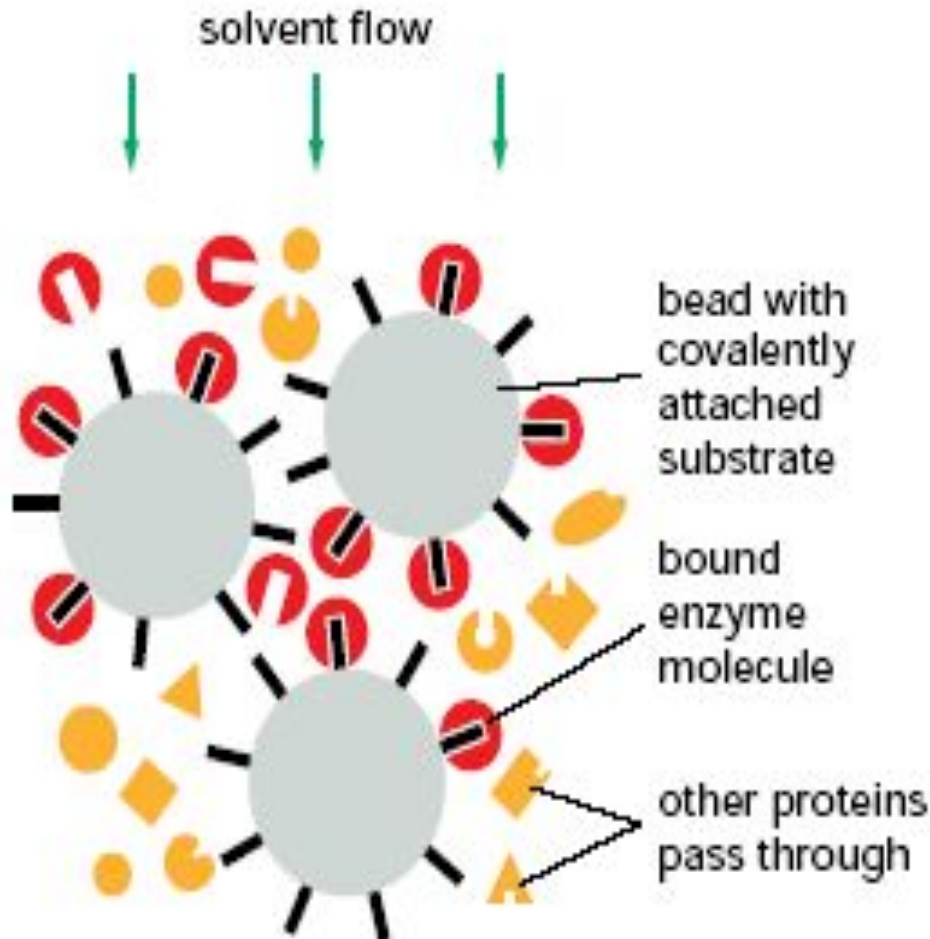

**Affinity columns** contain a **matrix** covalently coupled to a molecule that interacts specifically with the protein of interest

(e.g., an **antibody**, or an **enzyme substrate**).

Proteins that bind specifically to such a column can finally be **released** by a **pH change** or by **concentrated salt solutions**, and they emerge highly purified.

# Protein electrophoresis

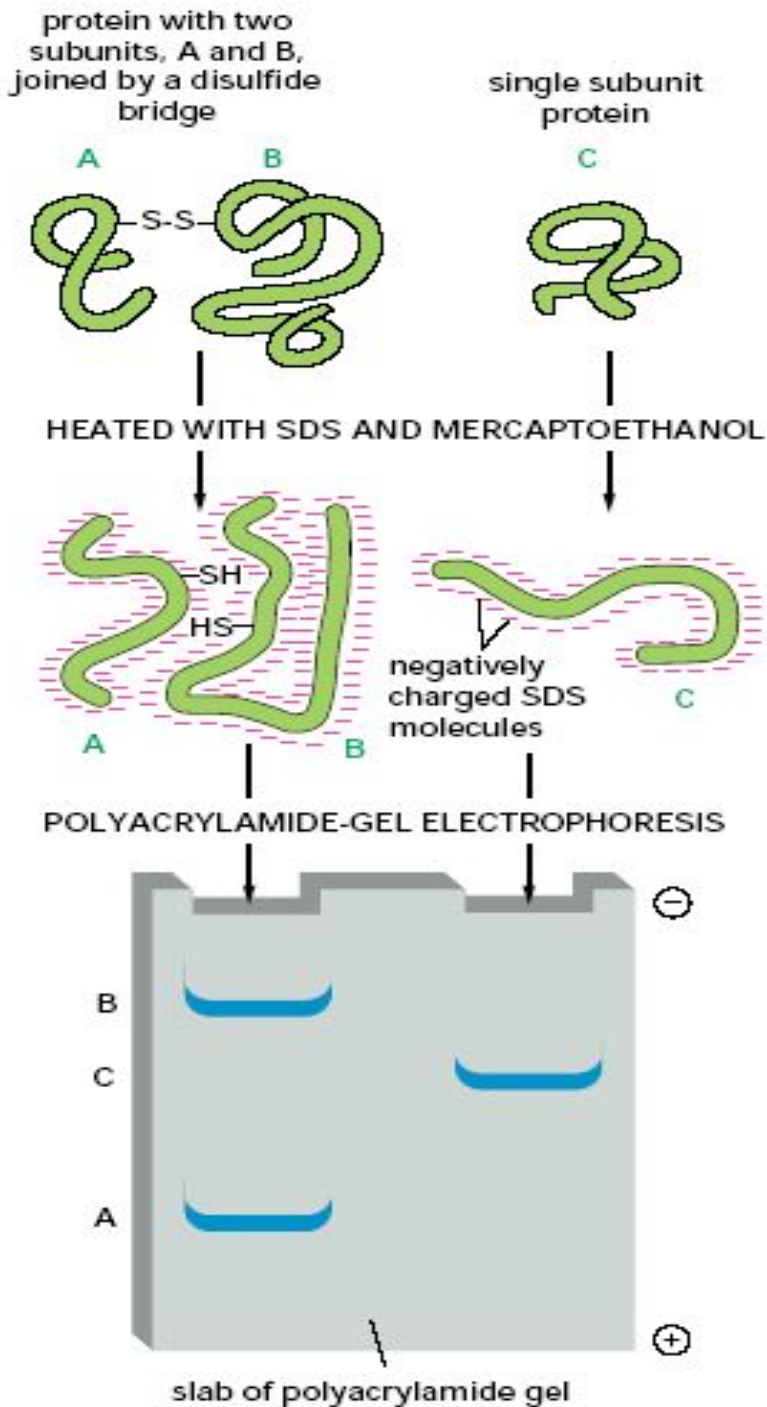

## GEL ELECTROPHORESIS

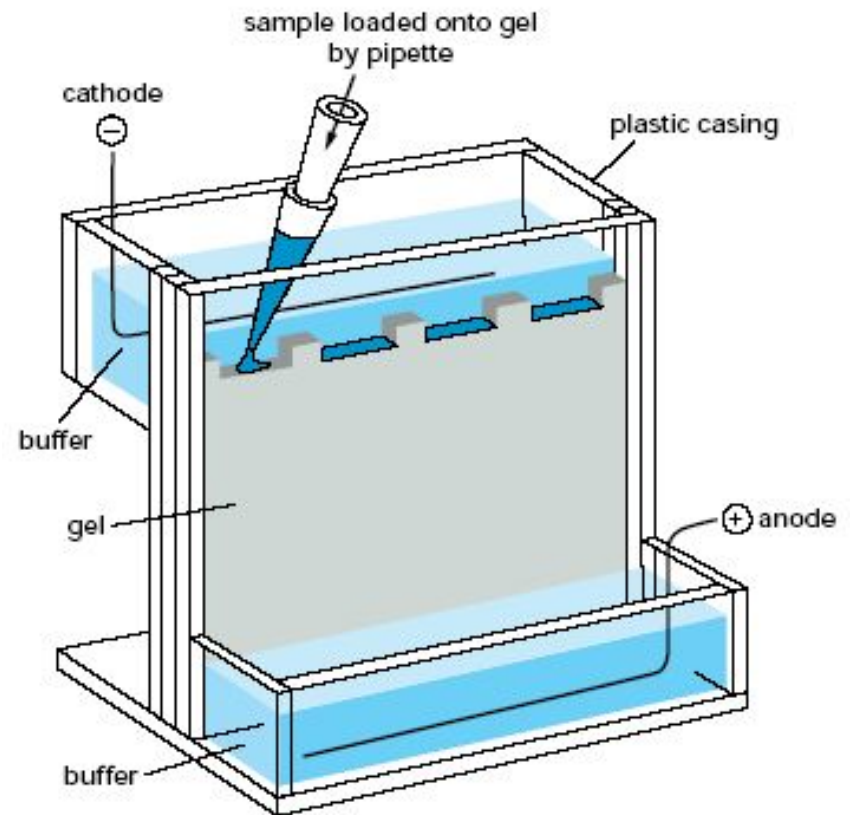

Essential Cell Biology: 51  
An Introduction to the Molecular Biology of the Cell

# Expression and Purification of Protein D

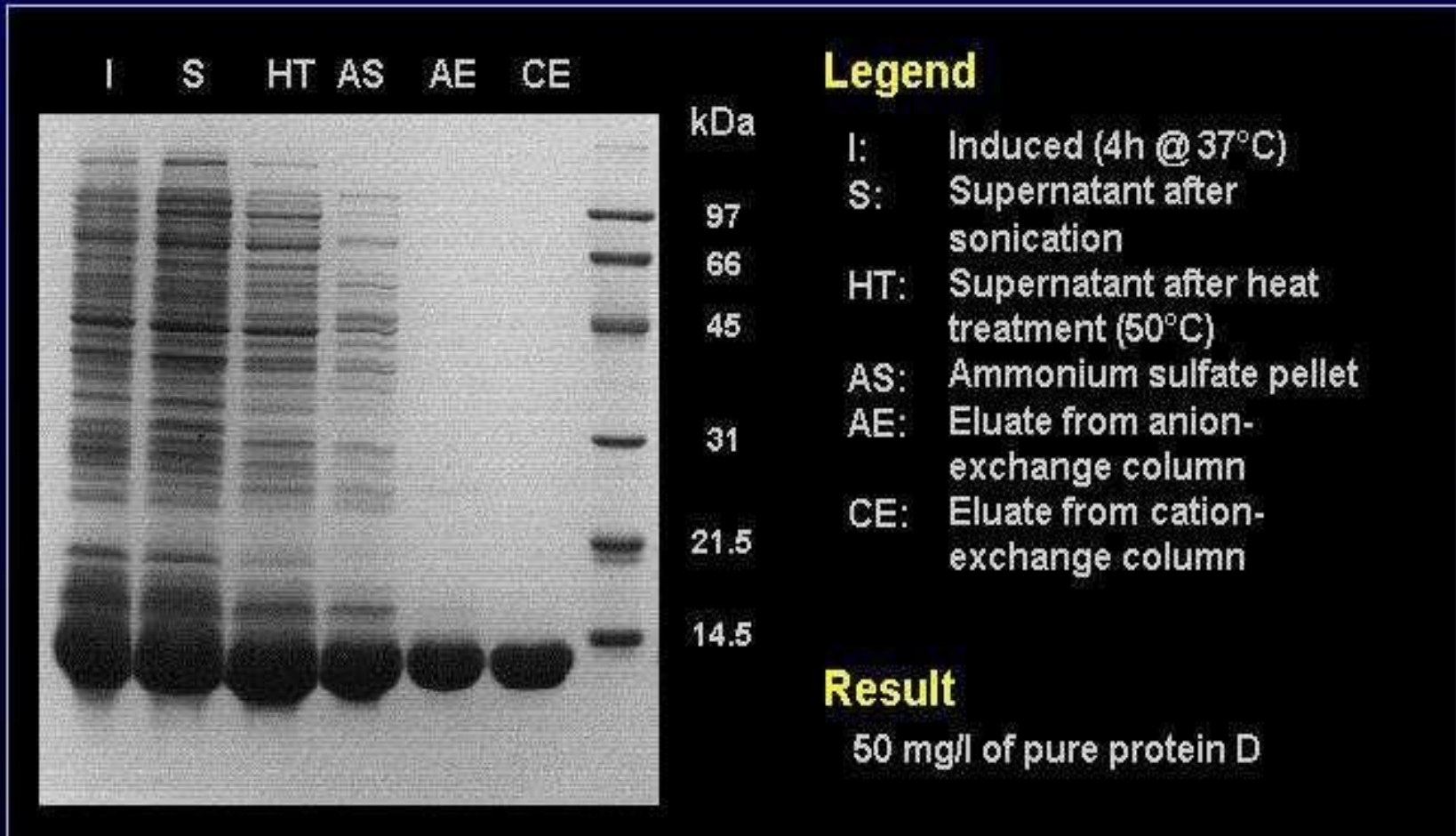



# Fusion proteins

- increase production level
- facilitate purification (tag)
- detection of expression (GFP fusion)
- Redirection of proteins (secretion -> signal peptidases)
- Surface display (for screening of libraries)
- Tandem arrays (for small peptides, toxic proteins,..)

# Most widely used purification strategy – to produce your protein as a fusion with something easily purifiable

## 6xHIS Tag

(Invitrogen, Life Technologies, Novagen, QIAGEN):

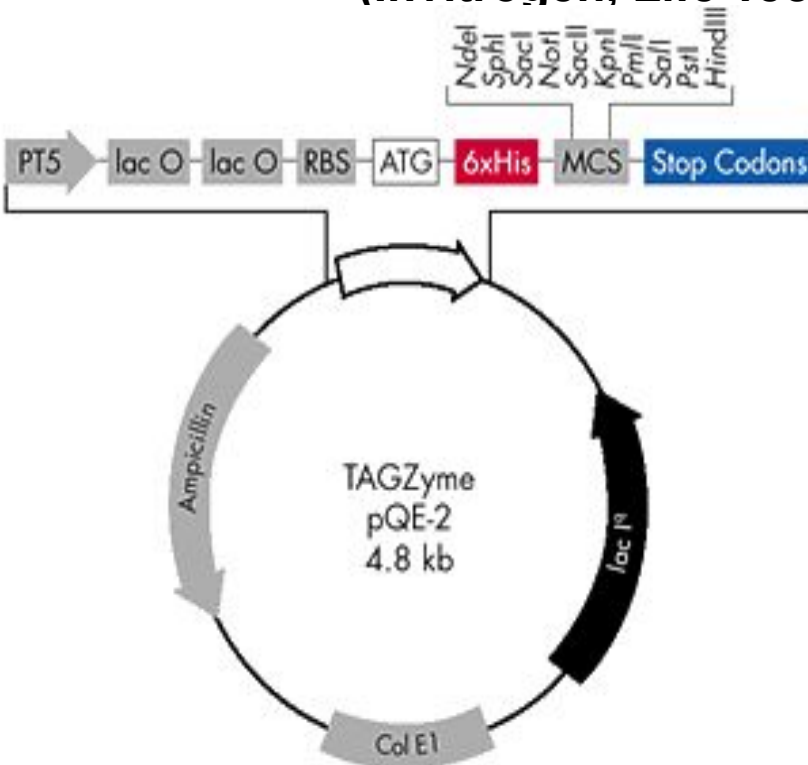

1. This small addition  
**rarely affects protein structure**  
to a significant degree

2. Interaction so strong,  
**it tolerates denaturing conditions**  
(could be used for  
inclusion bodies purification)

# Histidine: a charged aminoacid

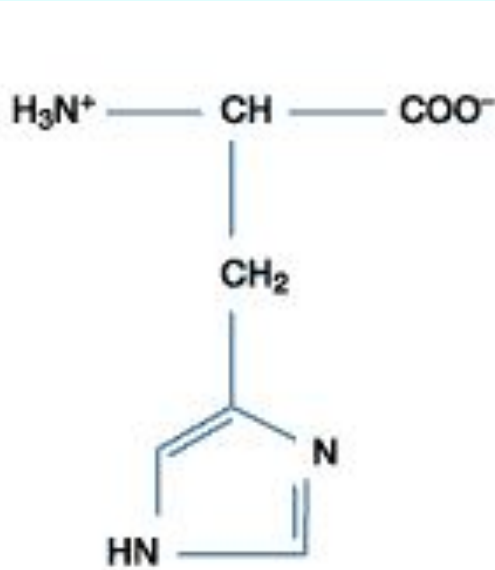

**Histidine**

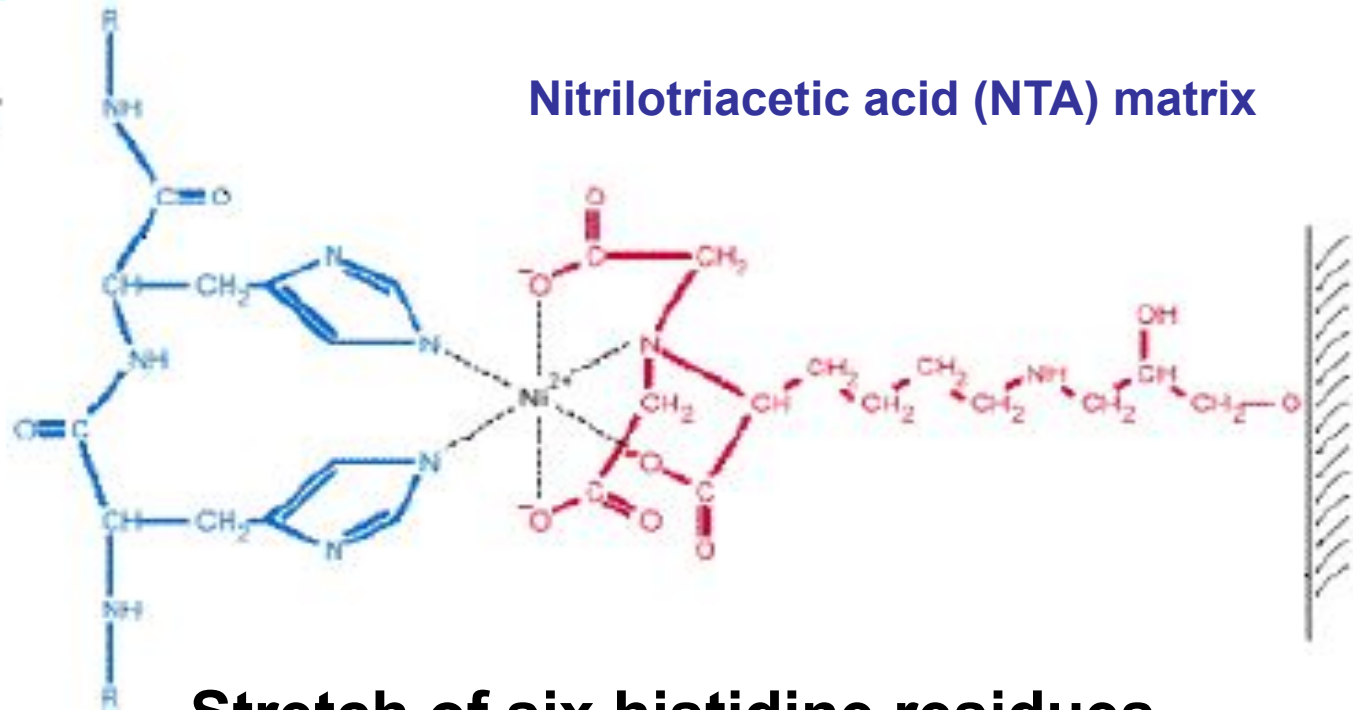

**Stretch of six histidine residues interacts with nickel ion that is tightly bound to a NTA matrix**

**The affinity of this interaction is very high which allows protein purification to 95% in a single step.**

# GST – fusion. Principle is the same. Binds to glutathion

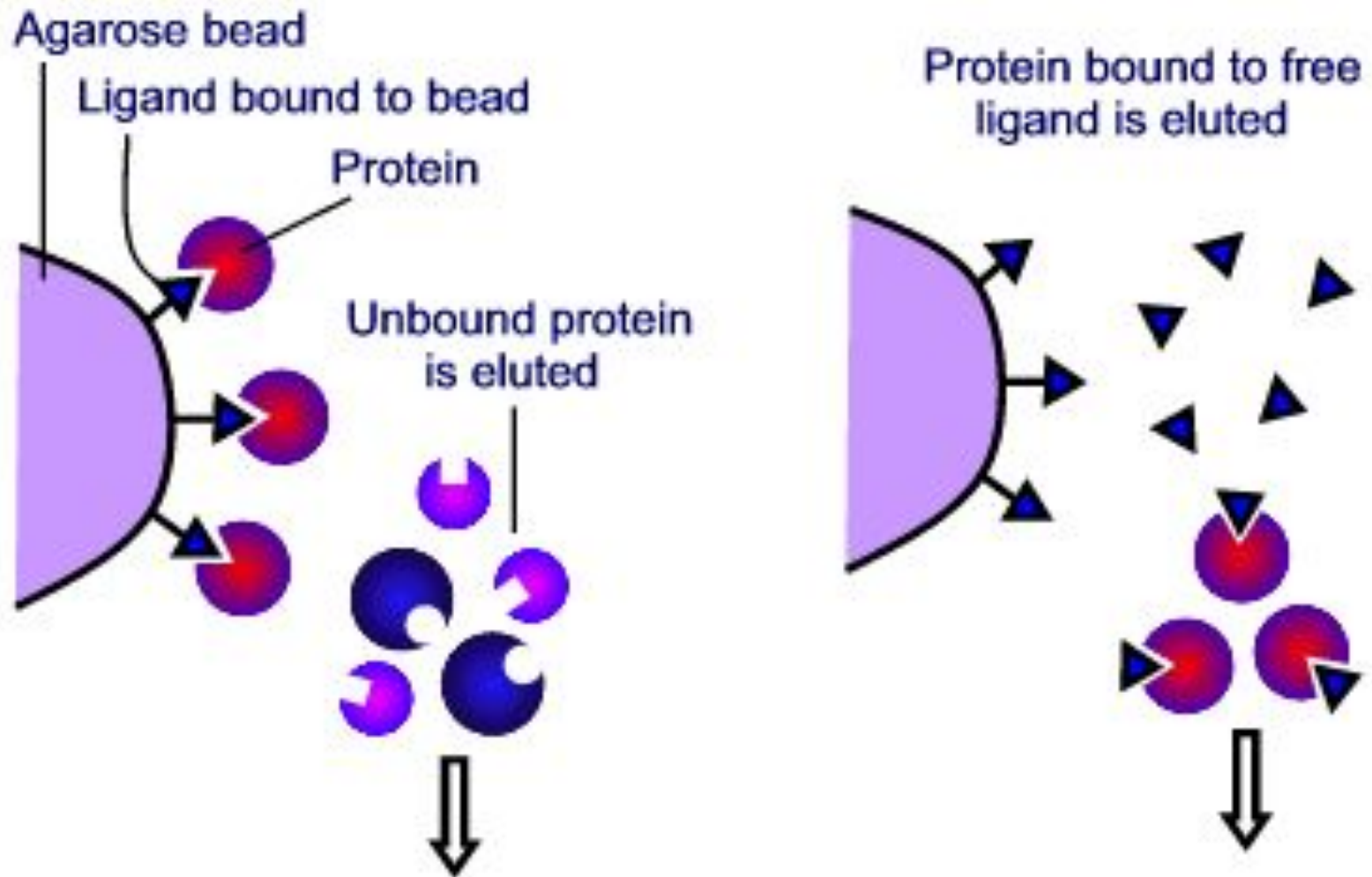

# FUNCTIONS OF GST

## CATALYTIC FUNCTIONS:

**Require strong  
binding to glutathione**

- Glutathione S-transferase activity
- Glutathione Peroxidase II activity

**GSTs function catalytically to conjugate glutathione (GSH)  
with a wide variety of electrophilic substrates**

- Reversible binding and transport of several organic compounds
- Irreversible binding and transport of several electrophilic compounds including some carcinogen

# Glutathione

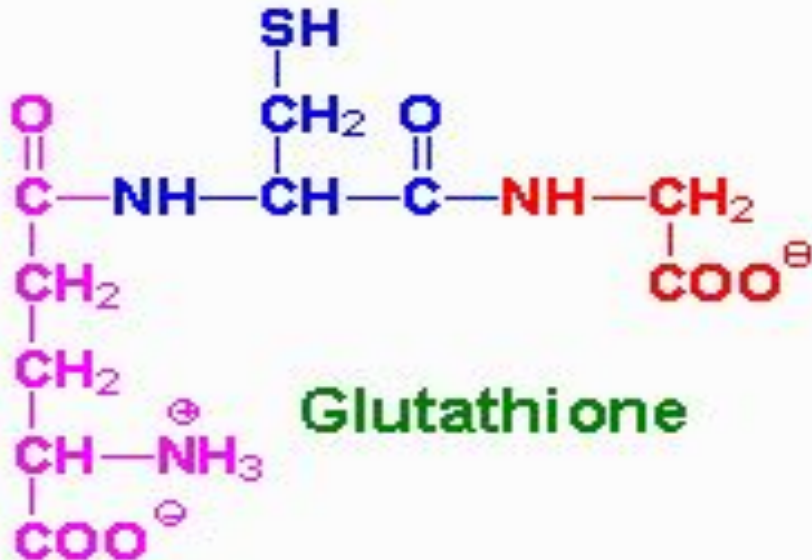
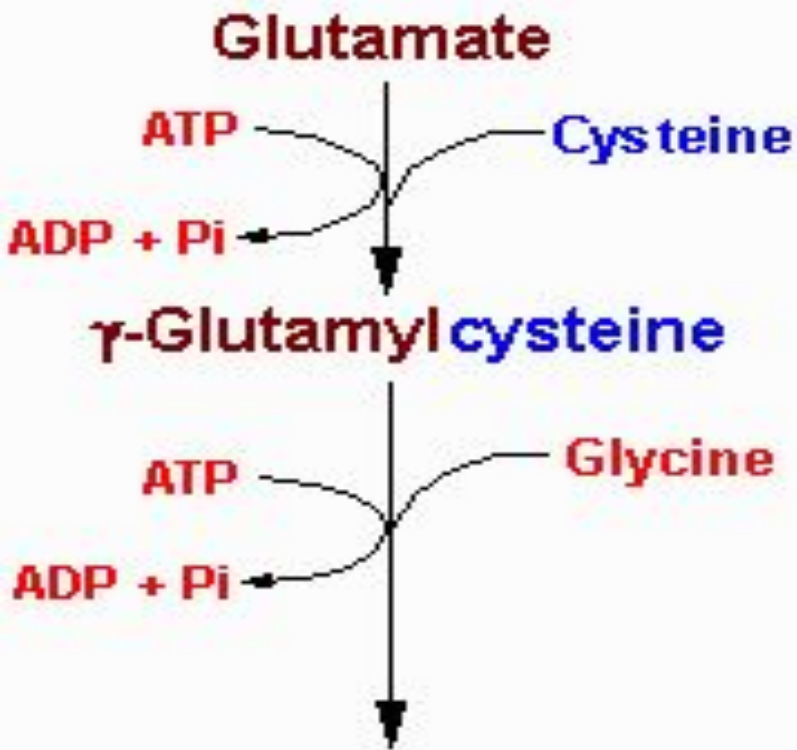

**GST from *Schistosoma japonicum***

**26 kDa tag**

- 1) Keeps fusion proteins soluble
- 2) Used for fusion purification
- 3) Used for protein detection with GST antibody

# FUSION PROTEIN BOUND TO GLUTATHIONE SEPHAROSE

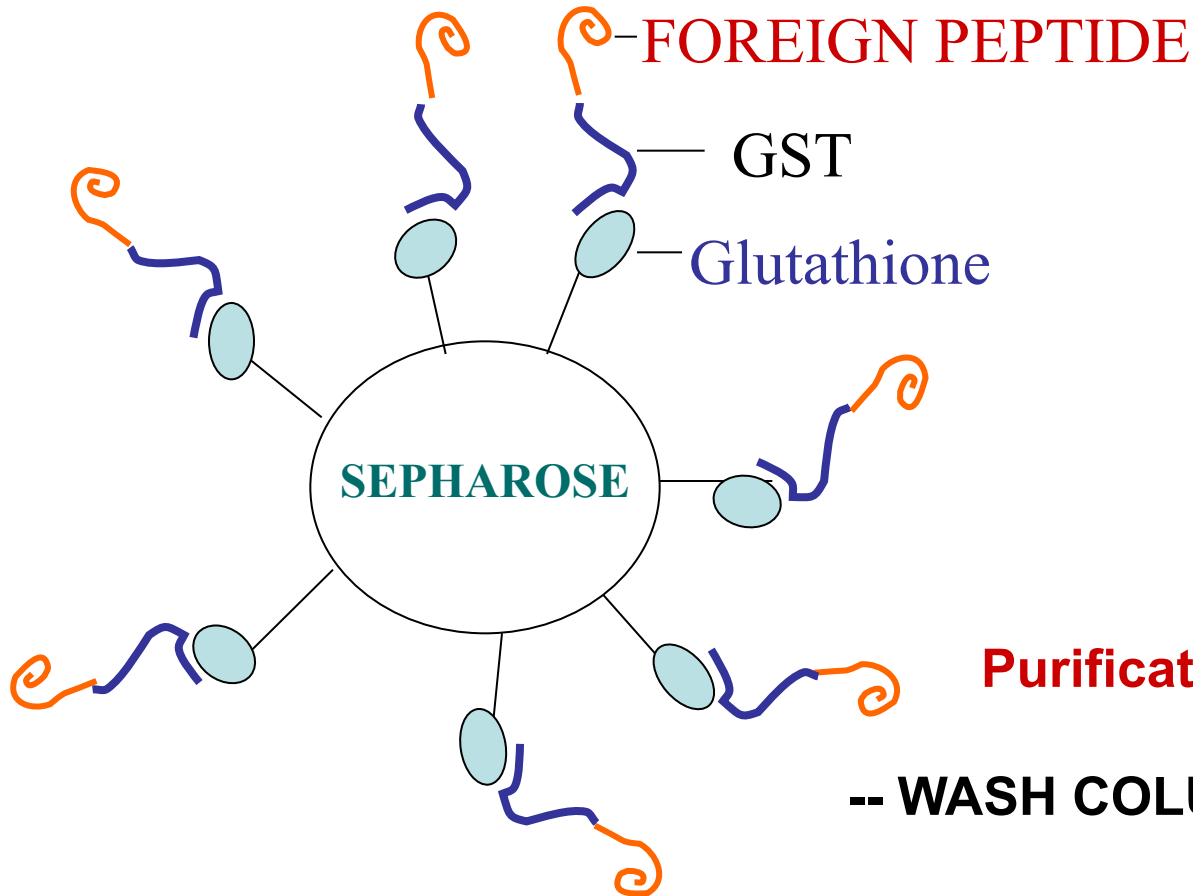

**Purification is simple :**

**-- WASH COLUMN EXTENSIVELY**

**-- ELUTE WITH REDUCED GLUTATHIONE**

**-- RESULTS IN PURE GST FUSION PROTEIN**



**Table 2b** Comparison of rare codons in *E. coli*

Organism	AGG arginine	AGA arginine	CUA leucine	AUA isoleucine	CCC proline	GGA glycine
Bacterial hosts						
<i>Escherichia coli</i> B	2.1	2.4	3.4	5.0	2.4	8.2
<i>E. coli</i> K12	1.2	2.1	3.9	4.3	5.5	7.9
<i>Anabaena</i> sp.	2.6	8.3	14.0	8.3	13.0	12.4
<i>Bacillus megaterium</i>	2.7	9.1	10.9	10.3	2.9	26.2
<i>Bacillus subtilis</i>	3.9	10.5	4.8	9.3	3.3	21.8
<i>Caulobacter crescentus</i> CB 15	2.2	0.8	1.4	0.6	18.7	4.3
<i>Methylobacterium extorquens</i>	1.2	0.6	0.8	0.3	18.7	3.7
<i>Staphylococcus carnosus</i>	0.4	7.9	4.6	9.8	0.8	16.7
<i>Streptomyces lividans</i>	4.0	1.1	0.6	0.8	22.7	6.5
Some organisms						
<i>Arabidopsis thaliana</i>	10.9	18.9	9.9	12.6	5.3	24.2
<i>Caenorhabditis elegans</i>	4.0	15.4	7.9	9.4	4.4	31.6
<i>Clostridium tetani</i> E88	5.0	25.5	11.2	67.4	1.8	34.6
<i>Drosophila melanogaster</i>	6.3	5.2	8.2	9.5	18.0	17.7
<i>Homo sapiens</i>	11.9	12.0	7.2	7.4	19.9	16.5
<i>H. sapiens</i> Mitochondriom	0.4	0.4	70.4	44.5	33.9	18.9
<i>Plasmodium falciparum</i>	3.3	17.0	5.3	40.8	3.0	20.0
<i>Pichia pastoris</i>	6.6	20.2	10.9	11.7	6.7	19.1
<i>Picrophilus torridus</i> DSM9790	22.9	16.2	7.8	30.3	2.6	18.1
<i>Saccharomyces cerevisiae</i>	9.3	21.3	13.4	17.8	6.8	10.9

The codon usages of bacteria used for heterologous protein expression and some organisms are listed (for *Bacillus brevis* not available). Codon frequencies are expressed as codons used per 1,000 codons encountered. The arginine codons AGG and AGA are recognized by the same tRNA and should therefore be combined. Codon frequency of more than 15 codons/1,000 codons may cause problems for high-level expression in *E. coli*. A complete summary of codon usages can be found at <http://www.kazusa.or.jp/codon/>



# Some problems of production in *E. coli*

**Table 2a** Some problems of heterologous protein production in *E. coli* and possible solutions

Symptom	Possible problem	A collection of solutions
Cell death or no colonies	Toxic protein, high basal expression	More stringent control over basal expression Tightly controlled promoter system Weaker promoter Lowering temperature Lowering inducer concentration
Insoluble disulfide protein (inclusion bodies)	Reduction of disulfide bonds	Minimize reduction in cytoplasm Accumulation in the periplasm
Insoluble protein (inclusion bodies)	Too much expression	Attenuate expression by: weaker promoter, lowering temperature, lowering inducer concentration, decrease plasmid copy number, fusion of a hydrophilic affinity tag
No activity	Misfolded protein, affinity tag can decrease activity	Minimize reduction in cytoplasm Accumulation in the periplasm Attenuate expression Change affinity tag
No protein, truncated protein	<i>E. coli</i> codon usage (codon bias)	Supply rare tRNAs Stronger promoter Increase plasmid copy number Lower temperature Tightly controlled promoter system

Nevertheless, another bacterial host than *E. coli* could also solve the problem

# Some *E.coli* expression host considerations

**Table 1** Some *E. coli* strains most frequently used for heterologous protein production and their key features

<i>E. coli</i> strain	Derivation	Key features
AD494	K-12	<i>trxB</i> mutant; facilitates cytoplasmic disulfide bond formation
BL21	B834	Deficient in <i>lon</i> and <i>ompT</i> proteases
BL21 <i>trxB</i>	BL21	<i>trxB</i> mutant; facilitates cytoplasmic disulfide bond formation; deficient in <i>lon</i> and <i>ompT</i> proteases
BL21 CodonPlus-RIL	BL21	Enhances the expression of eukaryotic proteins that contain codons rarely used in <i>E. coli</i> : AGG, AGA, AUA, CUA; deficient in <i>lon</i> and <i>ompT</i> proteases.
BL21 CodonPlus-RP	BL21	Enhances the expression of eukaryotic proteins that contain codons rarely used in <i>E. coli</i> : AGG, AGA, CCC; deficient in <i>lon</i> and <i>ompT</i> proteases.
BLR	BL21	<i>recA</i> mutant; stabilizes tandem repeats; deficient in <i>lon</i> and <i>ompT</i> proteases
B834	B strain	Met auxotroph; <sup>35</sup> S-met labeling
C41	BL21	Mutant designed for expression of membrane proteins
C43	BL21	Double mutant designed for expression of membrane proteins
HMS174	K-12	<i>recA</i> mutant; Rif resistance
JM 83	K-12	Usable for secretion of recombinant proteins into the periplasm
Origami	K-12	<i>trxB/gor</i> mutant; greatly facilitates cytoplasmic disulfide bond formation
Origami B	BL21	<i>trxB/gor</i> mutant; greatly facilitates cytoplasmic disulfide bond formation; deficient in <i>lon</i> and <i>ompT</i> proteases
Rosetta	BL21	Enhances the expression of eukaryotic proteins that contain codons rarely used in <i>E. coli</i> : AUA, AGG, AGA, CGG, CUA, CCC, and GGA; deficient in <i>lon</i> and <i>ompT</i> proteases
Rosetta-gami	BL21	Enhances the expression of eukaryotic proteins that contain codons rarely used in <i>E. coli</i> : AUA, AGG, AGA, CGG, CUA, CCC, and GGA; deficient in <i>lon</i> and <i>ompT</i> proteases; <i>trxB/gor</i> mutant; greatly facilitates cytoplasmic disulfide bond formation

Most strains are also available as DE3 and DE3 pLysS strains. Strains are commercially available from different manufacturers

# Principal factors in bacterial expression

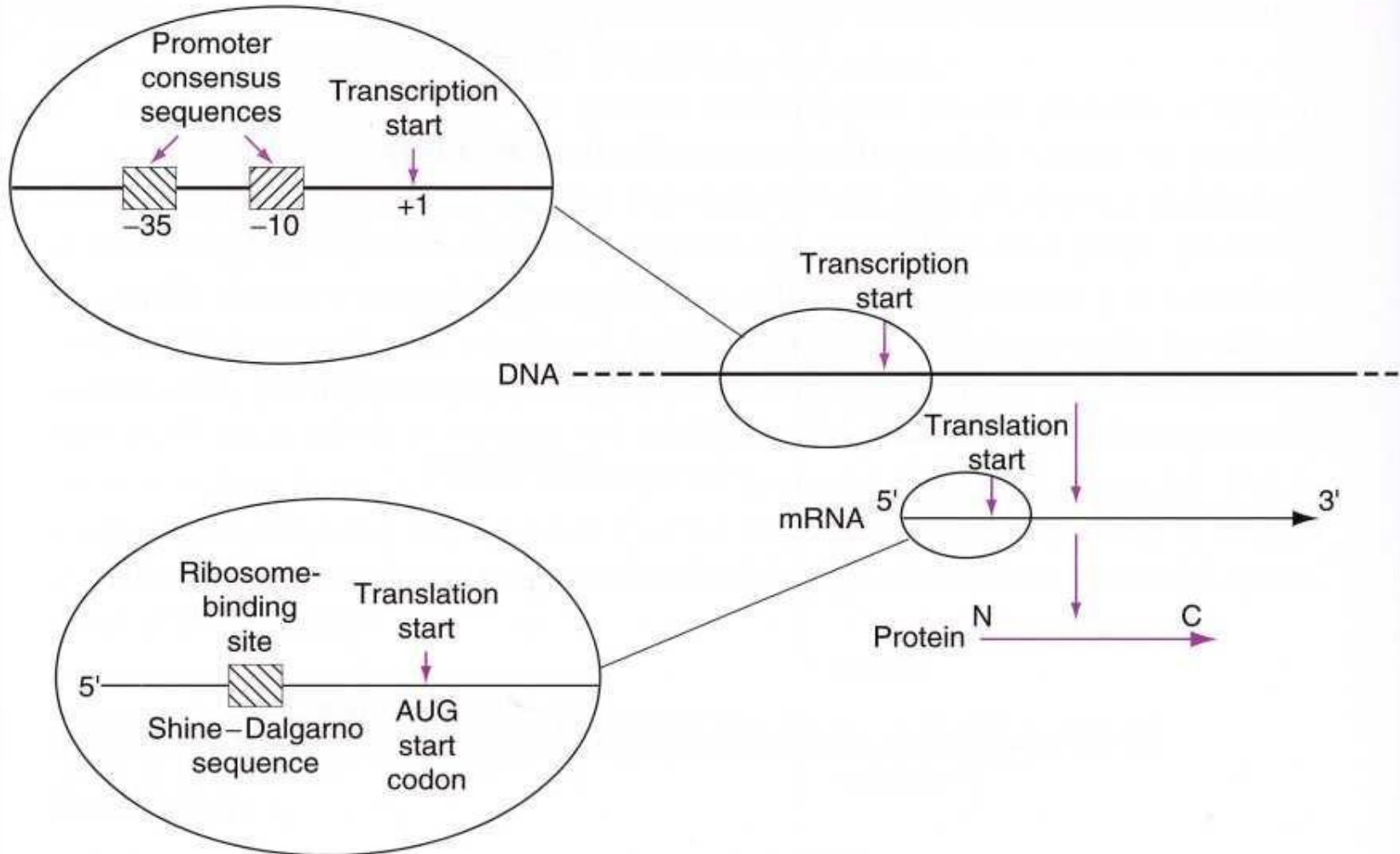

# Type of expression vectors

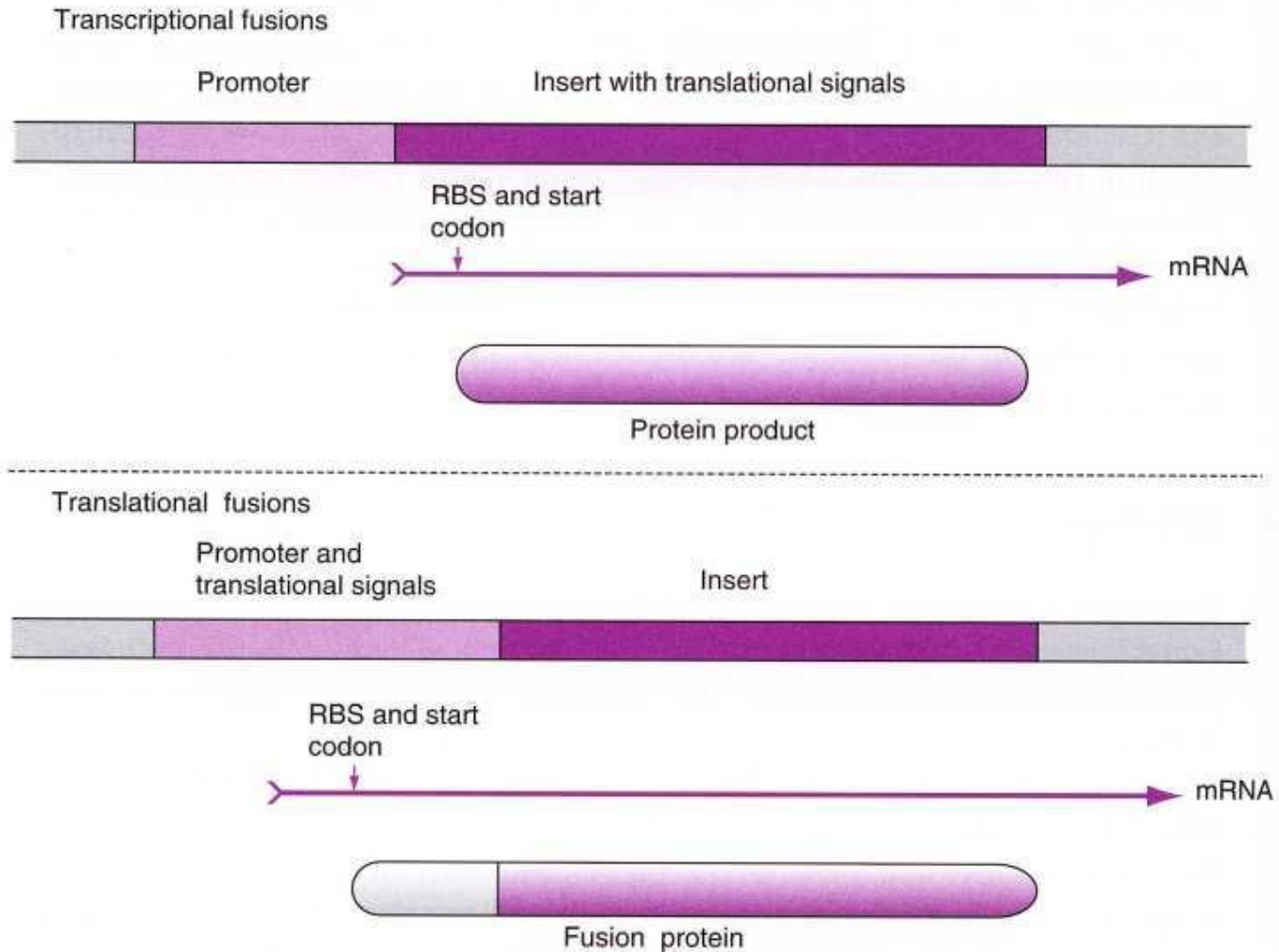

# Initiation of Transcription

## Promoters for Expression in Prokaryotes

- In *Escherichia coli*
  - *Lac* system - *plac*
  - *Trp* system
  - synthetic systems - *ptac*, *ptrc*
- In *Bacillus*

# The Lac promoter System

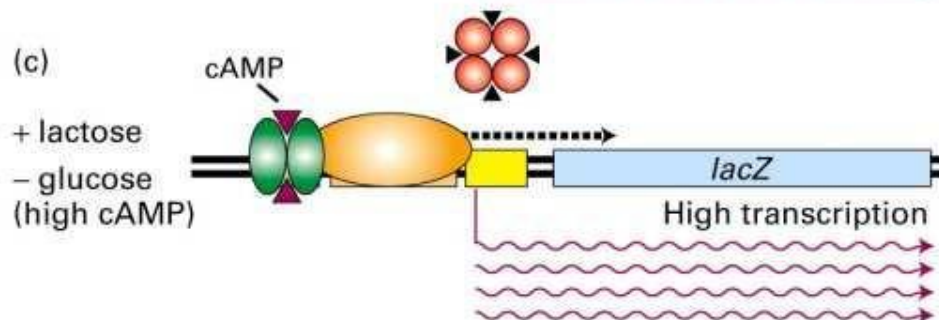
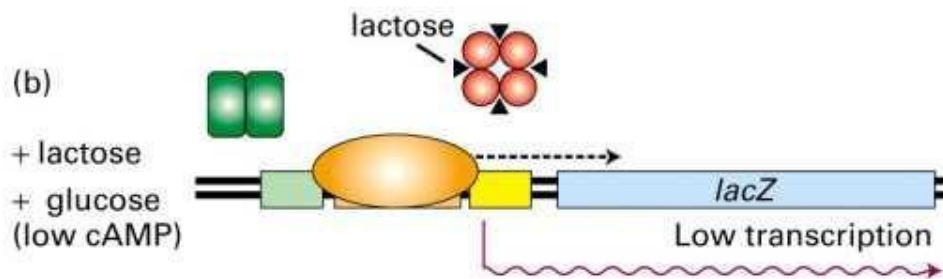
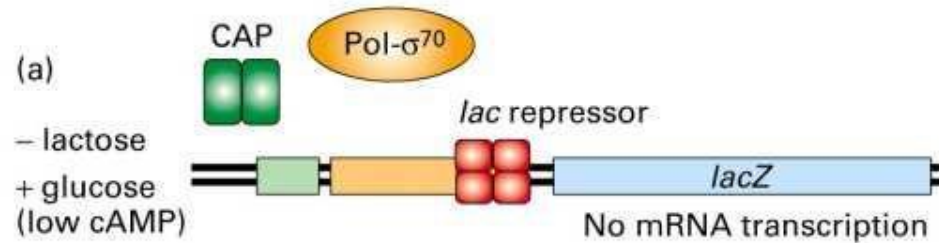
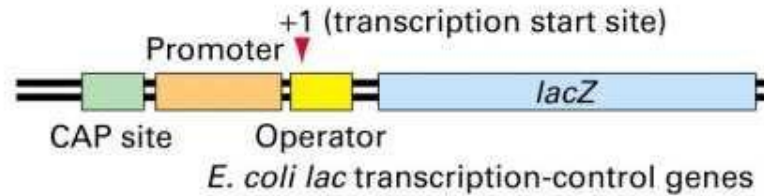

# The *trp* promoter system

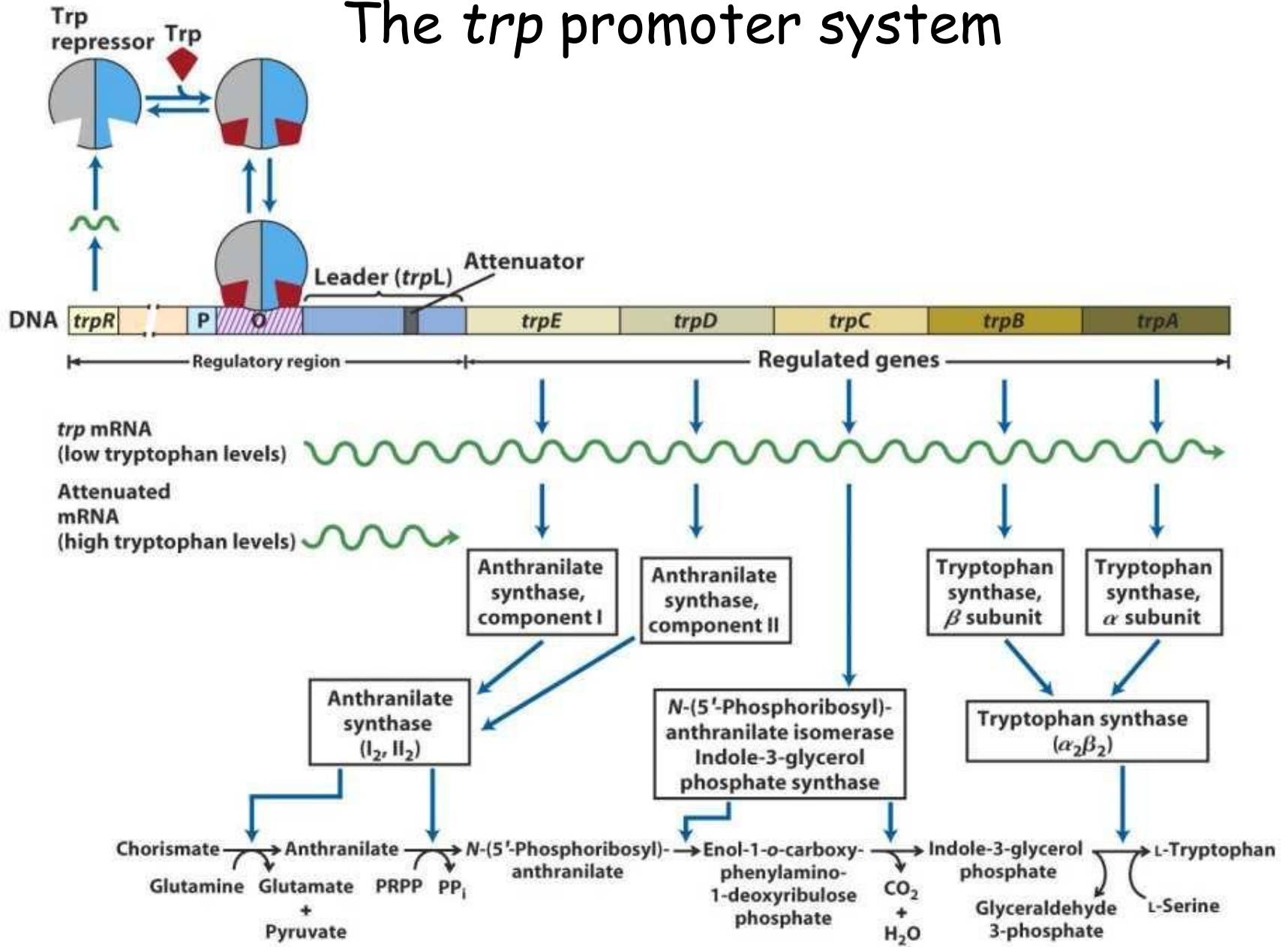



# *E. coli* Promoter Sites

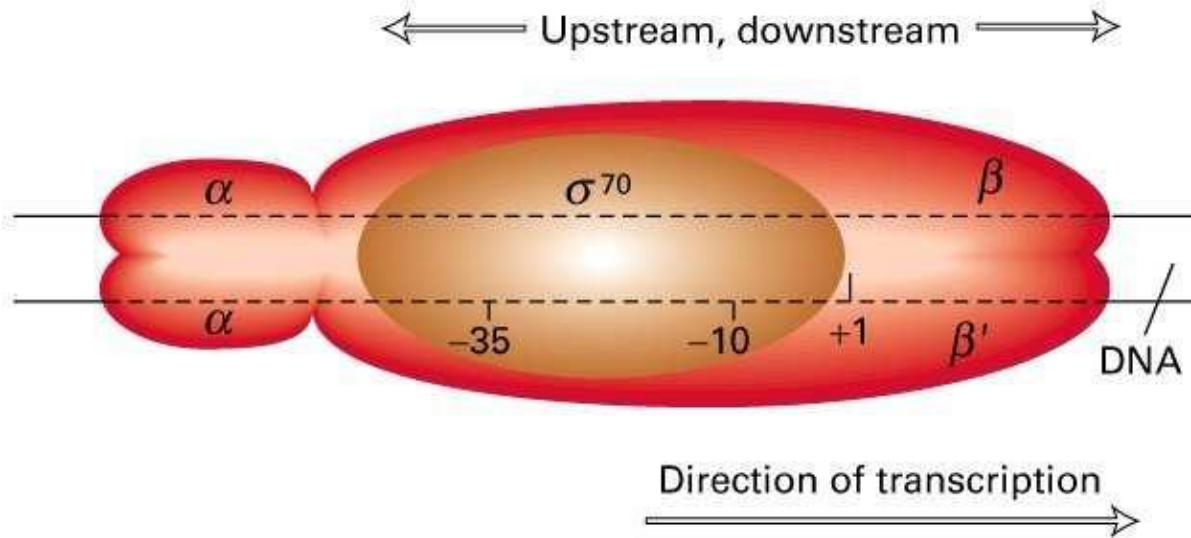
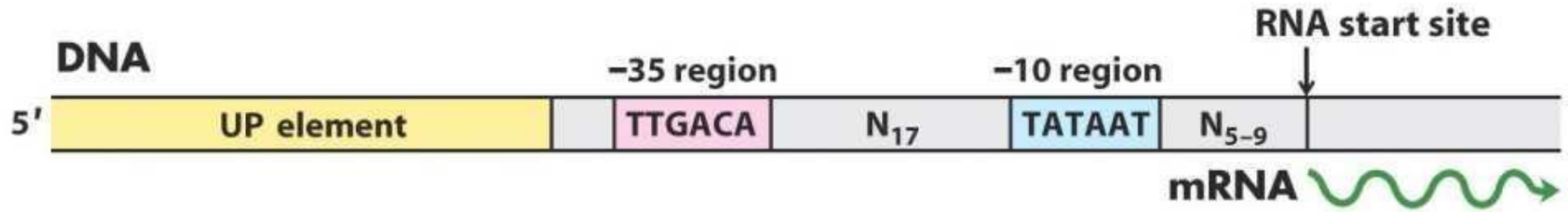



**TABLE I** Commonly Used Promoter Systems

Promoter	Repression requirements	Induction	Benefits	Drawbacks
<i>lac/lacUV5<sup>a</sup></i>	<i>lac I<sup>q</sup></i>	IPTG (lactose)	Strong promoter, easily induced	Leakage
<i>trp</i>	<i>trp R</i>	<i>trp</i> starvation or $\beta$ -IAA addition	Strong promoter	Difficult to repress, induction toxicity
<i>tac<sup>b</sup></i>	<i>lac I<sup>q</sup></i>	IPTG (lactose)	Very strong promoter, easily induced	Leakage
$P_L, P_Rc$	phage repressor (cI857)	Heat shock or nalidixic acid	Very strong promoter	Leakage, induction of SOS and heat shock responses, slow growth
<i>tac</i> or <i>lac</i> and phage <i>att</i> sites <sup>d</sup>	lysogen $\lambda xis^-cI857$	Short heat shock inverts promoter	Strong promoters, no leakage	Efficiency, timing of inversion may vary
T7 <sup>e</sup>	T7 lysozyme (pLys) or F' for infection	IPTG induces T7 pol expression T7 phage infection	Strong promoter, easily induced No leakage	Lysozyme toxicity in cells, some leakage may occur, Limited to engineered strains
<i>phoA<sup>f</sup></i>	<i>phoR</i>	Phosphate starvation	Inexpensive, growth regulated induction	May activate SOS response

<sup>a</sup> pSL301, Invitrogen.

<sup>b</sup> pKK223-3, Pharmacia; pPROK-1, Clontech.

<sup>c</sup> pPL-lambda, Pharmacia.

<sup>d</sup> pNH series, Stratagene.

<sup>e</sup> pET series, Novagen.

<sup>f</sup> pBAce, Stratagene.

# Inverted Promoter System (from Salmonella)

-> for very toxic proteins

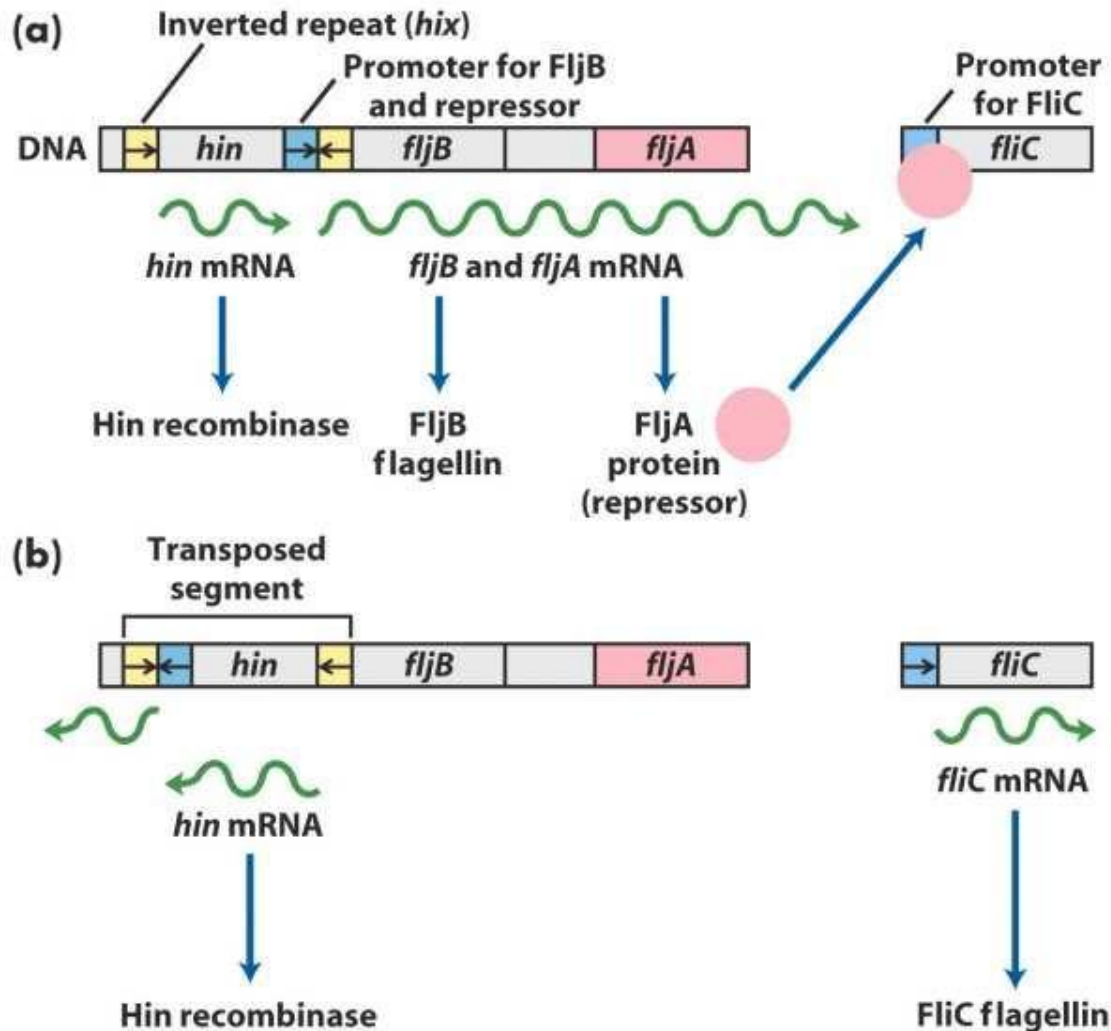

# Bacillus

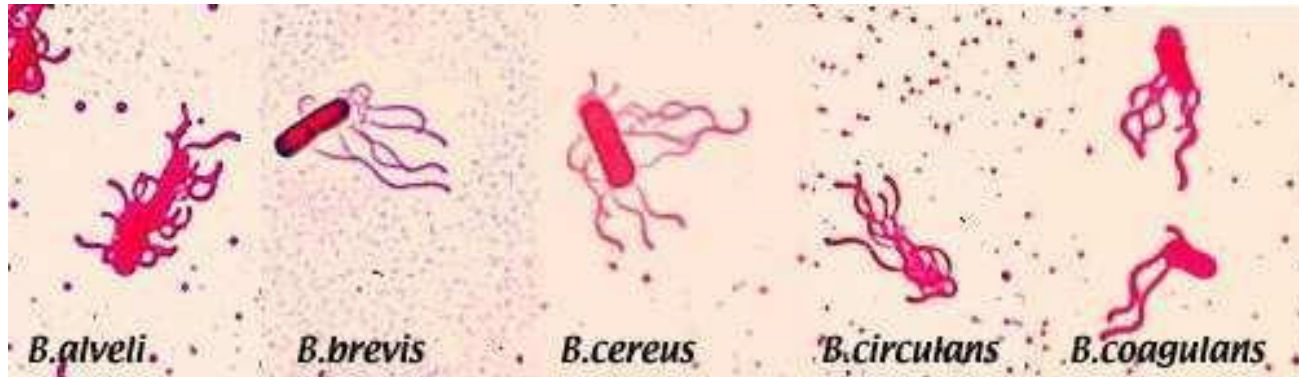

Flagellar stains of various species of *Bacillus* from CDC

In 1872, Ferdinand Cohn, a student of Robert Koch, recognized and named the bacterium *Bacillus subtilis*.

The organism was made to represent a large and diverse genus of Bacteria, *Bacillus*, and was placed in the family *Bacillaceae*.

The family's distinguishing feature is the production of **endospores**, which are highly refractile resting structures formed within the bacterial cells. Since this time, members of the genus *Bacillus* are characterized as Gram-positive, rod-shaped, aerobic or facultative, endospore-forming bacteria.

# Bacillus

- **Antibiotic Producers:** *B. brevis* (e.g. gramicidin, tyrothricin), *B. cereus* (e.g. cerexin, zwittermicin), *B. circulans* (e.g. circulin), *B. laterosporus* (e.g. laterosporin), *B. licheniformis* (e.g. bacitracin), *B. polymyxa* (e.g. polymyxin, colistin), *B. pumilus* (e.g. pumulin) *B. subtilis* (e.g. polymyxin, difficidin, subtilin, mycobacillin).
- **Pathogens of Insects:** *B. larvae*, *B. lentimorbis*, and *B. popilliae* are invasive pathogens. *B. thuringiensis* forms a parasporal crystal that is toxic to beetles.
- **Pathogens of Animals:** *B. anthracis*, and *B. cereus*. *B. alvei*, *B. megaterium*, *B. coagulans*, *B. laterosporus*, *B. subtilis*, *B. sphaericus*, *B. circulans*, *B. brevis*, *B. licheniformis*, *B. macerans*, *B. pumilus*, and *B. thuringiensis* have been isolated from human infections.
- The Genus *Bacillus* includes two bacteria of significant medical importance, *B. anthracis*, the causative agent of anthrax, and *B. cereus*, which causes food poisoning. Nonanthrax *Bacillus* species can also cause a wide variety of other infections, and they are being recognized with increasing frequency as pathogens in humans.

# Bacillus

- **Bacillus strains used as production organisms:**
  - *B. subtilis*
  - *B. brevis*
  - *B. licheniformis*
- **Transformation systems:**
  - **via competent cells** (during transition from vegetative cells -> sporulation, cell can take up DNA (ss) when population reaches a metabolic state called competence)
  - **protoplast**
  - **bacteriophage-mediated transduction**
- **Vectors:**
  - **replicating plasmids** (pUB110, pE194, pC194, pHP13, shuttle vectors)
    - > replicating plasmids with temperature-sensitive origin of replication (replication stops above certain temp. -> pE194 stops above 45°C)
  - **integrative vectors** (normally shuttle vectors)
- **Promoters:**
  - **aprE promoter** -> induction with onset of sporulation
  - **amylase promoter** -> growth-phase and nutrition regulated promoter (induction at end of exponential growth + repression by glucose)
  - **sacB promoter** (levansurase) -> not regulated
  - **spac promoter** -> hybrid promoter (subtilis phage + lac operator) -> induction with IPTG



# Bacillus as expression host

**Table 1**

Examples of Expression of Heterologous and Homologous Proteins in Bacilli

	Origin	Yield	<i>Bacillus</i> sp.	References
<b>Eukaryotic genes</b>				
Epidermal growth factor	Human	3 g/liter	<i>B. brevis</i>	Udaka and Yamagata (1993a)
Growth hormone	Human	0.2 g/liter	<i>B. brevis</i>	Udaka and Yamagata (1993a)
Growth hormone	Human	0.2 g/liter	<i>B. subtilis</i>	Honjo <i>et al.</i> (1987)
Growth hormone	Tuna	0.24 g/liter	<i>B. brevis</i>	Udaka and Yamagata (1993a)
IL-3	Human	0.10 g/liter	<i>B. licheniformis</i>	van Leen <i>et al.</i> (1991)
Pepsinogen	Swine	0.01 g/liter	<i>B. brevis</i>	Takao <i>et al.</i> (1989)
Salivary $\alpha$ -amylase	Human	0.06 g/liter	<i>B. brevis</i>	Udaka and Yamagata (1993a)
Isomerase (disulfide)	<i>Humicola insolens</i>	0.3 g/liter	<i>B. brevis</i>	Udaka and Yamagata (1993a)
Taka-amylase	<i>Aspergillus oryzae</i>	0.02 g/liter	<i>B. brevis</i>	Udaka and Yamagata (1993a)
<b>Bacterial genes</b>				
$\alpha$ -amylase	<i>B. licheniformis</i>	3.5 g/liter	<i>B. brevis</i>	Udaka and Yamagata (1993)
$\alpha$ -amylase	<i>B. licheniformis</i>	1.0 g/liter	<i>B. subtilis</i>	Sloma <i>et al.</i> (1988)
$\beta$ -lactamase	<i>B. licheniformis</i>	140m g/liter	<i>B. subtilis</i>	Yoshimura <i>et al.</i> (1986)
Cholera toxin B subunit	<i>Vibrio cholerae</i>	1.4 g/liter	<i>B. brevis</i>	Udaka and Yamagata (1993a)
Pertussis toxin S1	<i>B. pertussis</i>	100m g/liter	<i>B. subtilis</i>	Saris <i>et al.</i> (1990)
Pertussis toxin S4	<i>B. pertussis</i>	0.5m g/liter	<i>B. subtilis</i>	Saris <i>et al.</i> (1990)
Protein A	<i>S. aureus</i>	1 g/liter	<i>B. subtilis</i>	Fahnestock and Fisher (1986)
Subtilisin	<i>B. amyloliquefaciens</i>	60 mg/liter	<i>B. subtilis</i>	Ferrari <i>et al.</i> (1993)

# Bacillus as expression host

**Table 2**  
Advantages and Disadvantages of *Bacillus* Expression

Advantages	Disadvantages
Efficient transformation via natural competence <i>B. subtilis</i> is genetically well characterized.	Industrial strains not easy to transform
Laboratory strains easy to manipulate <i>B. subtilis</i> genome fully sequenced Availability of numerous plasmids	Poor efficiency of transformation of ligation mixtures.
Capable of secreting proteins into the medium Availability of several signal sequences Well-established fermentation protocol	Poor secretion of most heterologous proteins; degradation problems
Can grow efficiently on inexpensive feedstock GRAS status of its products	Genetics and physiology of the fermentation not well understood

# Products produced in Prokaryotic Systems

- Restriction Endonucleases -> produced in *E. coli*
- L- Ascorbic Acid (Vitamin C) -> recombinant *Erwinia herbicola* (gram-negative bacterium)
- Synthesis of Indigo (blue pigment -> dye cotton / jeans) -> produced in *E. coli*
- Amino Acids -> produced in *Corynebacterium glutamicum* (gram-positive bacterium)
- Lipases (laundry industry) -> from *Pseudomonas alcaligenes* produced in *Pseudomonas alcaligenes*
- Antibiotica (most of them from *Streptomyces*, other gram-positive bacteria, fungi) -> produced in recombinant *Streptomyces* and fungi (*Penicillium*)
- Biopolymers (PHB -> biodegradable plastics) -> produced in *E. coli* (stabilized with parB)

# Expression in Eukaryotic Systems

- Yeast
  - *Saccharomyces cerevisiae* (baker's yeast)
  - *Pichia pastoris*
- Insect Cells - Baculovirus
- Mammalian Cells

# Expression in Yeast

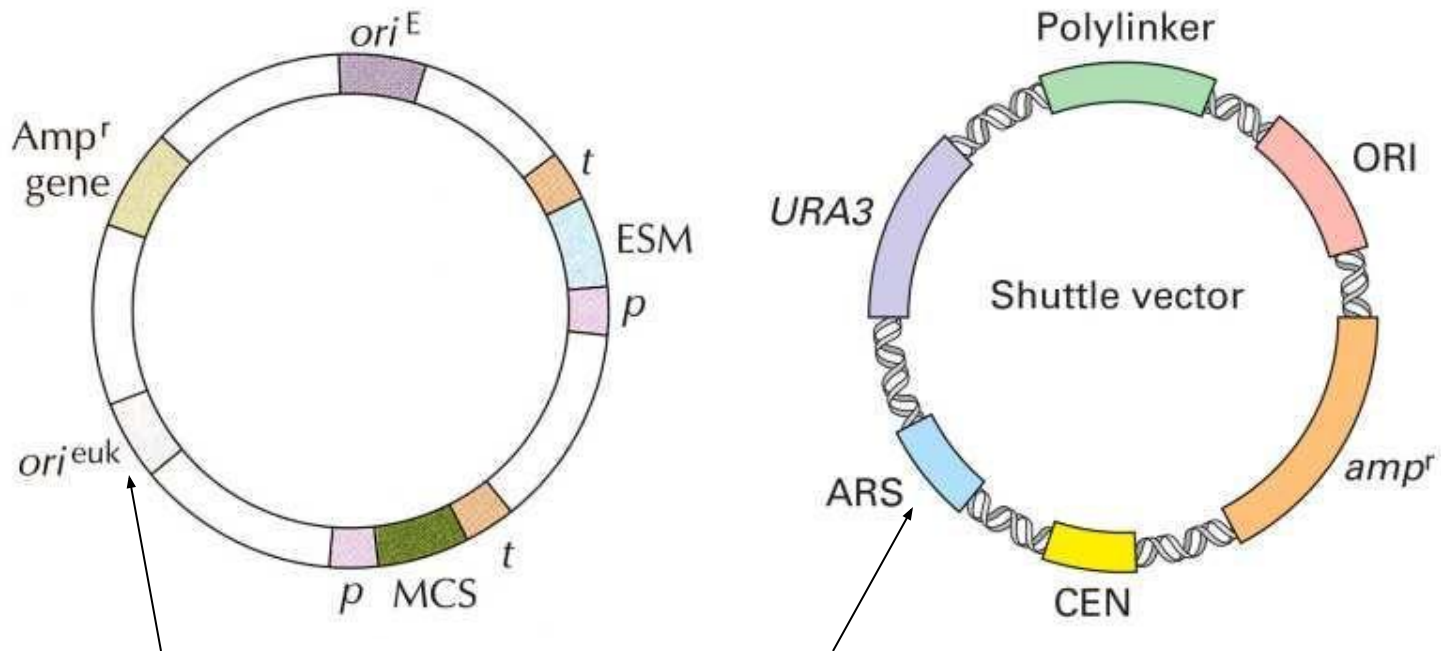

Autonomous replicating vectors → shuttle vectors

# Expression in *Saccharomyces cerevisiae*

## Autonomous replicating systems

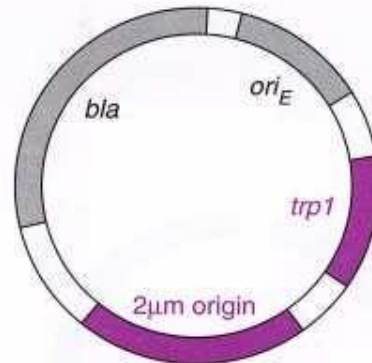

**Figure 6.15** Structure of a yeast episomal vector: *bla* = beta-lactamase (ampicillin resistance); *ori* = origin of replication in *E. coli*; *trp1* = selectable marker in *S. cerevisiae* auxotrophs; 2 μm origin = origin of replication in *S. cerevisiae*

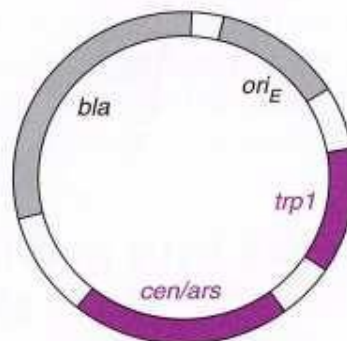

**Figure 6.16** Structure of a yeast centromere vector: *bla* = beta-lactamase (ampicillin resistance); *ori* = origin of replication in *E. coli*; *trp1* = selectable marker in *S. cerevisiae* auxotrophs; *cen/ars* = centromere and autonomously replicating sequence, providing an origin of replication in *S. cerevisiae*

# Expression in *Saccharomyces cerevisiae*

## Integrative systems

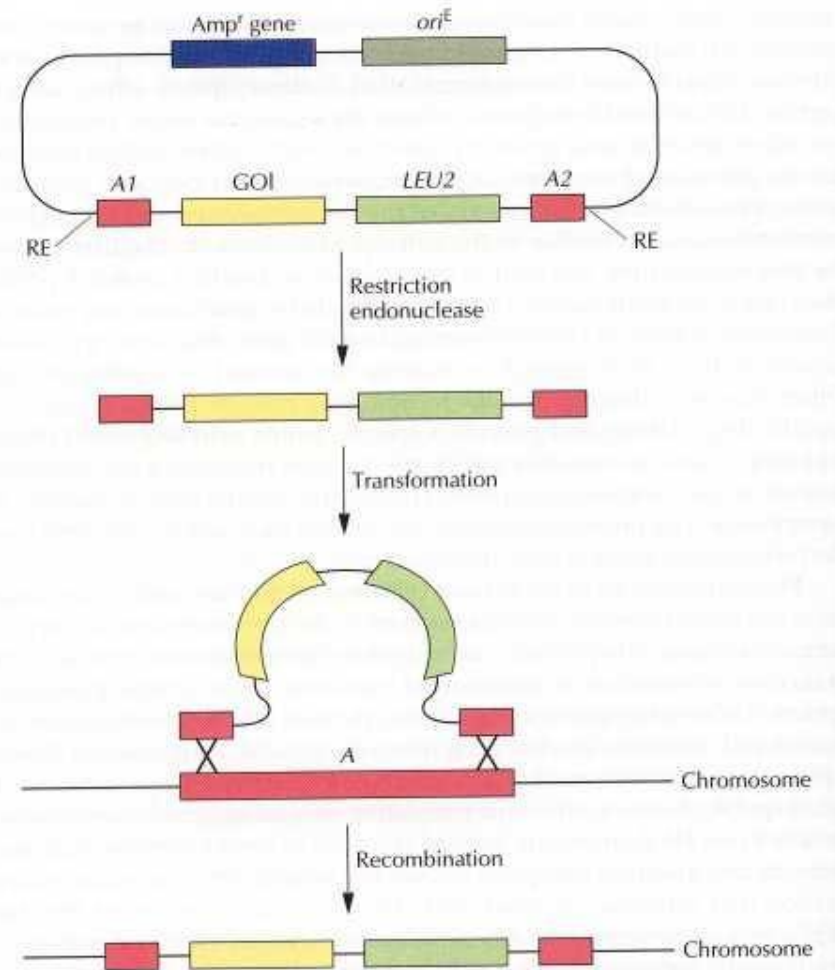
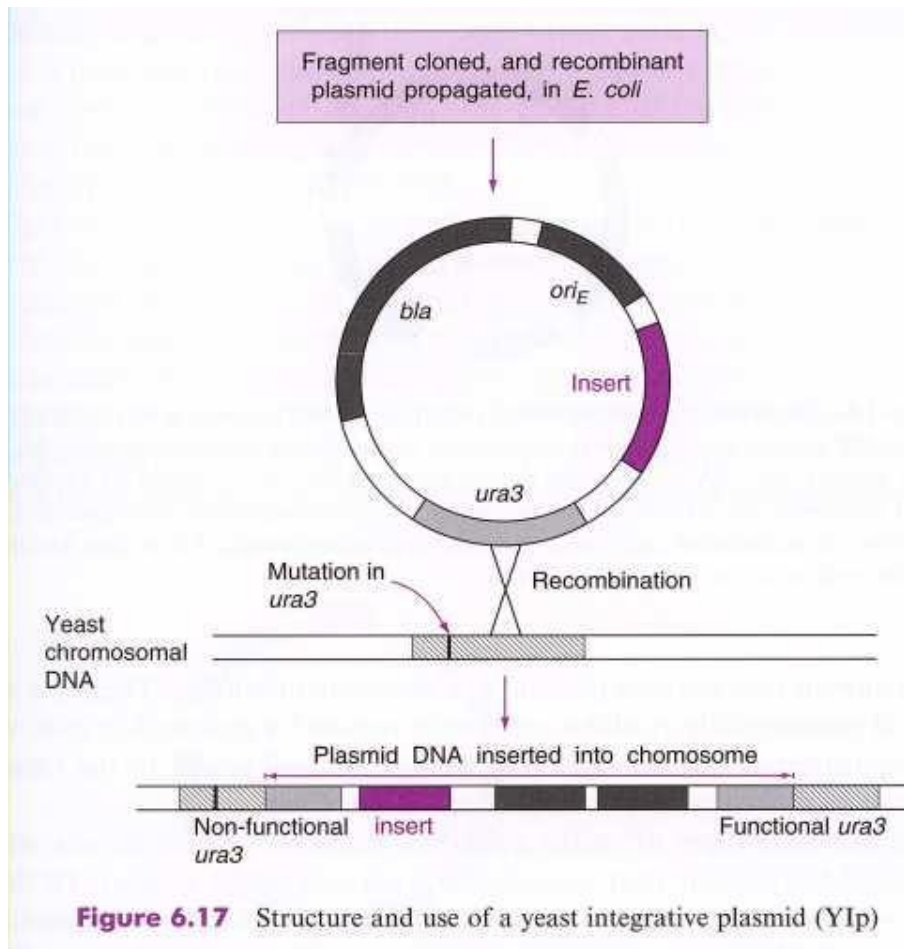

Probability for integration higher with linear fragments



# Expression in *Saccharomyces cerevisiae*

**TABLE II** Examples of Vectors for Yeast Expression

Plasmid type	Copy number	Selectable marker <sup>a</sup>	Comments
Integrative (YIp)	One	<i>URA3, LEU2</i>	Stable integration into chromosome
Multi-integrative	One–five	<i>URA3, LEU2</i>	Stable integration into chromosome
Centromere (YCp)	One–two	<i>TRP1, URA3, LEU2, HIS3</i>	Stable autonomously replicating from <i>ARS</i> element or 2- $\mu$ m origin
<i>ARS</i> (YRp)	Moderate	<i>TRP1</i>	Autonomously replicating but unstable
2 $\mu$ m (YEp)	Moderate	<i>LEU2, URA3, HIS3</i>	Autonomously replicating but fairly stable
2 $\mu$ m (YEp)	High	<i>LEU2-d, POT</i>	Autonomously replicating, stable

<sup>a</sup> Examples of the common selectable markers available for each vector type; other combinations of selectable markers and vector type have been developed in individual laboratories.

# Expression in *Saccharomyces cerevisiae*

Table 7.1 Promoters for *S. cerevisiae* expression vectors

Promoter	Expression conditions	Status
Acid phosphatase ( <i>PH05</i> )	Phosphate-deficient medium	Inducible
Alcohol dehydrogenase I ( <i>ADHI</i> )	2–5% Glucose	Constitutive
Alcohol dehydrogenase II ( <i>ADHII</i> )	0.1–0.2% Glucose	Inducible
Cytochrome <i>c</i> <sub>1</sub> ( <i>CYC1</i> )	Glucose	Repressible
Gal-1-P Glc-1-P uridylyltransferase	Galactose	Inducible
Galactokinase ( <i>GAL1</i> )	Galactose	Inducible
Glyceraldehyde-3-phosphate dehydrogenase ( <i>GAPD</i> , <i>GAPDH</i> )	2–5% Glucose	Constitutive
Metallothionein ( <i>CUP1</i> )	0.03–0.1 mM copper	Inducible
Phosphoglycerate kinase ( <i>PGK</i> )	2–5% Glucose	Constitutive
Triose phosphate isomerase ( <i>TPI</i> )	2–5% Glucose	Constitutive
UDP galactose epimerase ( <i>GAL10</i> )	Galactose	Inducible

**TABLE I** Partial List of Human Proteins Produced in *Saccharomyces cerevisiae* at High Levels<sup>a,b</sup>

Protein (molecular weight)	Reference/source
<b>Cytoplasmic expression</b>	
Cu, Zn superoxide dismutase (15.7 kDa)	Hallewell <i>et al.</i> , 1987, 1991
$\gamma$ -Interferon (16.8 kDa)	Derynck <i>et al.</i> , 1983; Fieschko <i>et al.</i> , 1987
Fibroblast growth factor (18 kDa)	Barr <i>et al.</i> , 1988; G. McKnight, pers. comm.
Hepatitis B surface antigen (22 kDa)	Hitzeman <i>et al.</i> , 1983a; Miyanohara <i>et al.</i> , 1983; McAleer <i>et al.</i> , 1984; Bitter and Egan, 1984; Bitter <i>et al.</i> , 1988; Jacobs <i>et al.</i> , 1989
Hepatitis B core antigen (22 kDa)	Kniskern <i>et al.</i> , 1986
Lipocortin V (35 kDa)	M. Irani, pers. comm.
Ga <sub>1</sub> subunit (41 kDa)	T. Jones and V. L. MacKay, unpublished
$\alpha$ -1-Antitrypsin (44.7 kDa)	Cabezón <i>et al.</i> , 1984; Casolaro <i>et al.</i> , 1987
Platelet-derived endothelial cell growth factor (45 kDa)	Finnis <i>et al.</i> , 1992
Hemoglobin (62 kDa)	Wagenbach <i>et al.</i> , 1991; Coghlan <i>et al.</i> , 1992; Ogden <i>et al.</i> , 1991, 1992
cAMP phosphodiesterase isozyme IV (77 kDa)	McHale <i>et al.</i> , 1991
Coagulation factor XIIIa (83 kDa)	Bishop <i>et al.</i> , 1990
HIV-1 reverse transcriptase (117 kDa)	Bathurst <i>et al.</i> , 1990
<b>Secretory expression</b>	
Epidermal growth factor (5.5 kDa)	Brake <i>et al.</i> , 1984; George-Nascimento <i>et al.</i> , 1988
Insulin precursors (6 kDa)	Thim <i>et al.</i> , 1986
Insulin-like growth factor I (7.5 kDa)	Bayne <i>et al.</i> , 1988; Steube <i>et al.</i> , 1991
Parathyroid hormone (9.4 kDa)	Gabrielsen <i>et al.</i> , 1990
Granulocyte-macrophage colony-stimulating factor (14 kDa)	Miyajima <i>et al.</i> , 1986; Ernst, 1988
Lysozyme (14.7 kDa)	Jigami <i>et al.</i> , 1986; Taniyama <i>et al.</i> , 1988; Ichikawa <i>et al.</i> , 1989
Interleukin-1 $\alpha$ , $\beta$ (17 kDa)	Baldari <i>et al.</i> , 1987; Ernst, 1988; Livi <i>et al.</i> , 1990
$\alpha$ -Interferon (20 kDa)	Hitzeman <i>et al.</i> , 1983b; Singh <i>et al.</i> , 1984; Bitter <i>et al.</i> , 1984; Mellor <i>et al.</i> , 1985; Chang <i>et al.</i> , 1986; Zsebo <i>et al.</i> , 1986
Growth hormone (22 kDa)	Hitzeman <i>et al.</i> , 1984; Tokunaga <i>et al.</i> , 1985; Hiramatsu <i>et al.</i> , 1990
Interleukin-6 (22 kDa)	Guisez <i>et al.</i> , 1991
Erythropoietin (24 kDa)	Elliott <i>et al.</i> , 1989
Platelet-derived growth factor (30 kDa)	Kelly <i>et al.</i> , 1985; Östman <i>et al.</i> , 1989
Thrombin zymogens (36–69 kDa)	H. Han and V. L. MacKay, unpublished
Single-chain urokinase (47 kDa)	Melnick <i>et al.</i> , 1990
$\beta$ 1–4 Galactosyltransferase (48 kDa)	Krezdorn <i>et al.</i> , 1993
Chimeric L6 antibody Fab (48 kDa)	Horwitz <i>et al.</i> , 1988; Better and Horwitz, 1989

Yeast are efficient secretors !

Secretory expression preferred if:

-> if product toxic

-> if many S-S bonds need to be closed

(Continues)

# Expression in *S. cerevisiae* - *Pichia pastoris*

## Problems with production in *S. cerevisiae*:

- For some proteins production level low
- Hyperglycosylation (more than 100 mannose residues in N-glycosylation)
- Sometimes secretion not good -> protein stack in cells (periplasma)
- *S. cerevisiae* produces high amount of EtOH -> toxic for the cells -> effects level of production

## Advantages of production in *Pichia pastoris*:

- Highly efficient promoter, tightly regulated (alcohol oxidase -> AOX, induced by MeOH)
- Produces no EtOH -> very high cell density -> secretion very efficient
- Secretes very few proteins -> simplification of purification of secreted proteins

# Expression in *Pichia pastoris*

## Integrative systems

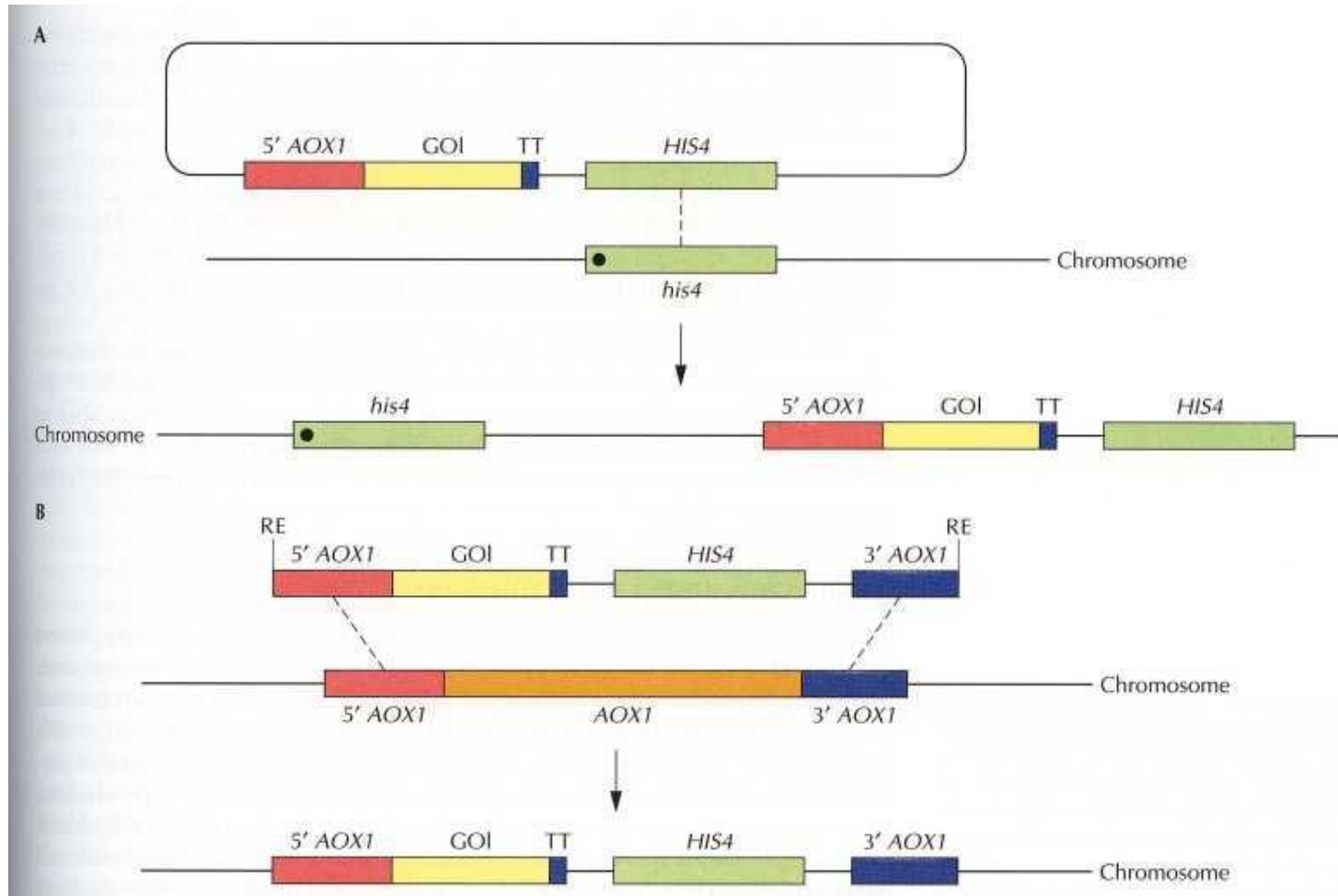

# Expression in *Pichia pastoris*

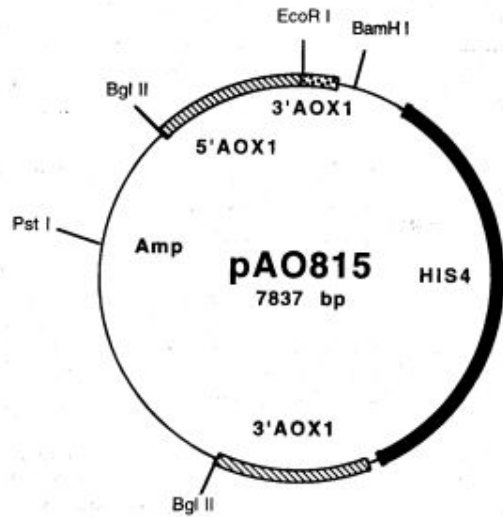

**Figure 2** *P. pastoris* expression vector pAO815. The thin line represents sequences from *E. coli* plasmid pBR322 (with permission from Cregg and Higgins, 1995).

**Table 2**  
Common *P. pastoris* Expression Vectors

Vector name	Selectable markers	Feature	Reference
<i>Intracellular</i> <i>pHIL-D2</i>	HIS4	NotI sites for <i>AOX1</i> gene replacement	K. Sreekrishna (personal communication)
pAO815	HIS4	Expression cassette bounded by <i>Bam</i> HI and <i>Bgl</i> II sites for generation of multicopy expression vector	Thill <i>et al.</i> (1990)
pPIC3K	HIS4 and <i>kan<sup>r</sup></i>	Multiple cloning sites for insertion of foreign genes; G418 selection for multicopy strains	Scorer <i>et al.</i> (1993b)
pPICZ	<i>ble<sup>r</sup></i>	Multiple cloning sites for insertion of foreign genes;	Higgins <i>et al.</i> (1998)

(continues)

# Expression in *Pichia pastoris*

**Table 4**

Advantages and Disadvantages of the *P. pastoris* Expression System

Advantages	Disadvantages
<p><b>Culturing</b></p> <ul style="list-style-type: none"> <li>Rapid growth rate</li> <li>High-cell density: &gt;100 g (dcw)/liter</li> <li>Clean medium composed of salts, biotin, and carbon source</li> <li>Easily scaled up to large-volume, high-density fermentor cultures</li> </ul>	<ul style="list-style-type: none"> <li>Fermentor culturing often needed to achieve high level of foreign protein</li> </ul>
<p><b>Molecular genetics</b></p> <ul style="list-style-type: none"> <li>Classical genetic methods available</li> <li>Molecular methods similar to <i>S. cerevisiae</i></li> <li>Stable integrated expression vectors</li> </ul>	<ul style="list-style-type: none"> <li>Range of vectors limited</li> </ul>
<p><b>Promoters</b></p> <ul style="list-style-type: none"> <li>AOX1p—strong, tightly regulated, and easily controlled</li> <li>GAPp—strong constitutive</li> </ul>	
<p><b>Expression</b></p> <ul style="list-style-type: none"> <li>Eukaryotic environment aids folding of higher eukaryotic foreign proteins</li> <li>High expression levels</li> </ul>	
<p><b>Secretion</b></p> <ul style="list-style-type: none"> <li>Proper posttranslational modifications               <ul style="list-style-type: none"> <li>Sulfhydryl bond formation</li> <li>Signal sequence processing</li> <li>Folding</li> <li>Glycosylation</li> </ul> </li> <li>High levels—g/liter fermentor cultures</li> <li>Few yeast proteins in medium—high initial purity of foreign protein</li> </ul>	<ul style="list-style-type: none"> <li>Improper posttranslational modifications</li> <li>Native signals not always processed</li> <li>Some proteins misfold and become stuck in secretory pathway</li> <li>Lower eukaryotic (high mannose)-type glycosylation</li> <li>Proteases in medium degrade some foreign proteins</li> </ul>



# Expression in Insect cells

- **Baculovirus:**

- > infects invertebrates (insects)

- > in infection cycle 2 forms of baculovirus are formed:

- > single virus particle

- > in protein matrix (polyhedron) trapped clusters of viruses

- > during late stage of infection massive amount of polyhedron produced -> strong promoter

- > polyhedron not required for virus production

- > **polyhedron promoter** optimal for heterologous protein production in insect cells

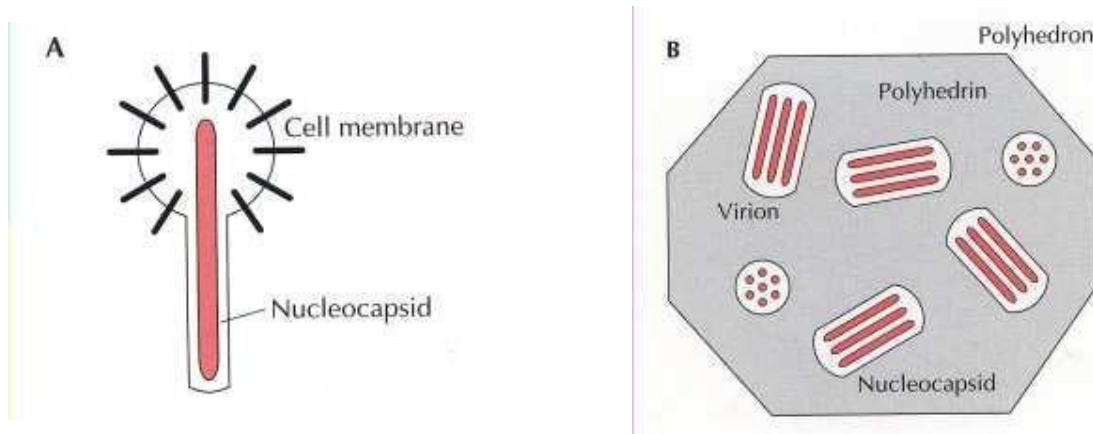

# Expression in Insect cells

- **Baculovirus:**

- > *Autographa californica* multiple nuclear polyhedrosis virus (**AcMNPV**) many used as expression vector

- > **Production of recombinant baculovirus:**

1. create a transfer vector (*E. coli* based plasmid with AcMNPV DNA - polyhedrin promoter/terminator + flanking sequences) -> gene of interest cloned downstream of promoter

2. Insect cells are cotransfected with virus (AcMNPV) + transfer vector

- > in some double infected cells -> double crossover event (recombination)

- > produce recombinant virus (bacmid -> *E. coli* - insect cell baculovirus shuttle vector)

- > cells infected with recombinant virus -> produce plaques (lack of polyhedrin)

3. DNA hybridisation + PCR used to identify recombinant virus

4. Infection of insect cells with concentrated stock of verified recombinant virus

- > 4-5 days later protein harvested

# Baculovirus expression system

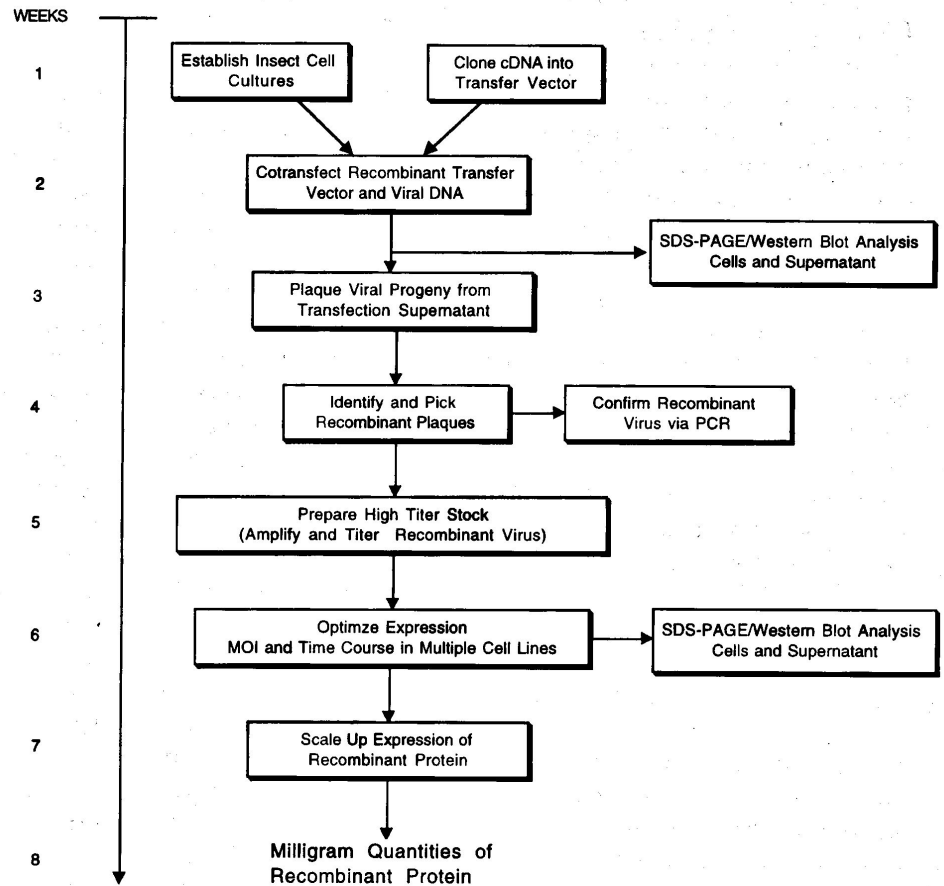
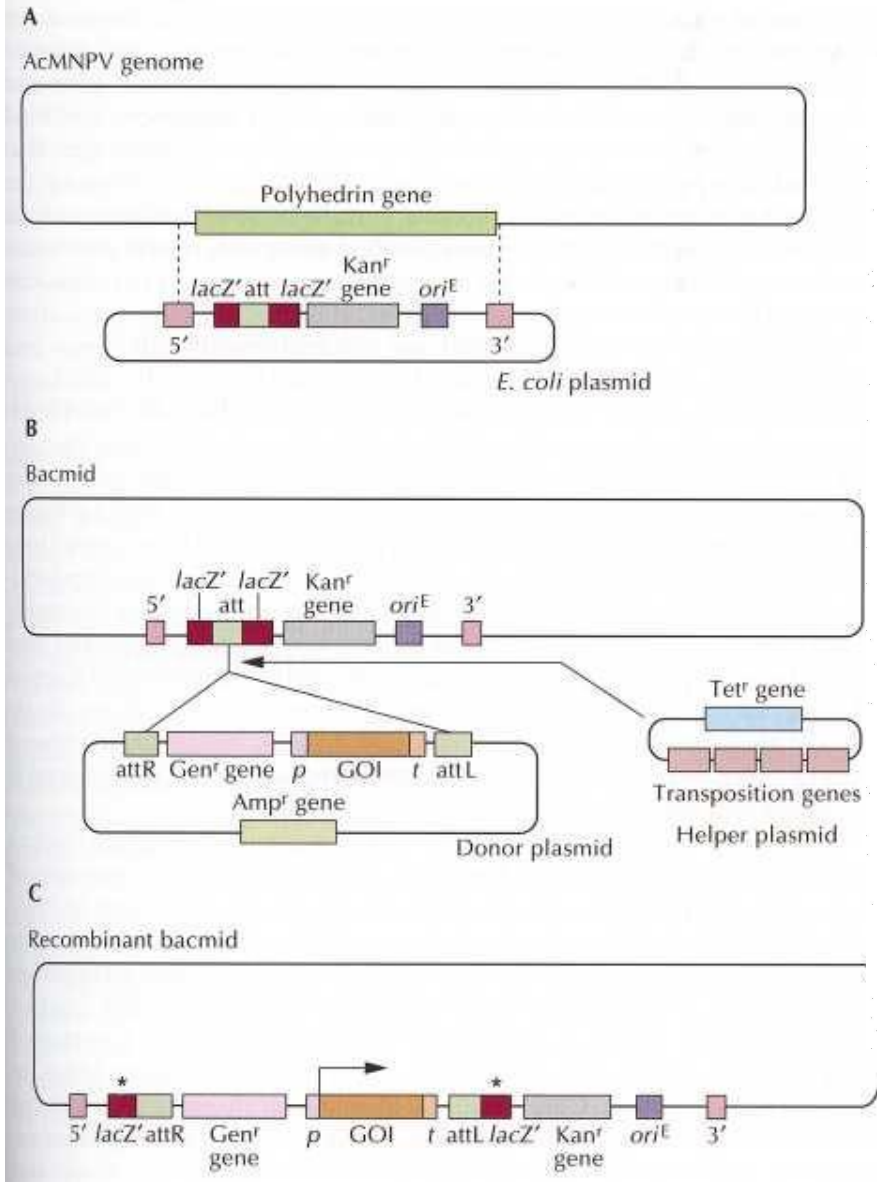

**Figure 2** Flow chart of BEVS outlining the generation and characterization of recombinant baculoviruses.

# Baculovirus expression system

**Table 4**  
Heterologous Protein Expression

Protein	Origin	Reference
$\beta$ -Hexoaminidase B	Human	Pennybacker <i>et al.</i> (1997)
Myosin light chain kinase	Human	Lin <i>et al.</i> (1997)
DNA helicase II	Human	Zhang and Grosse (1997)
Bullous pemphigoid antigen 2	Human	Masunaga <i>et al.</i> (1997)
Lymphotoxin- $\alpha$ 1 $\beta$ 2 complex	Human	Williams-Abbott <i>et al.</i> (1997)
Werner's syndrome (WRN) helicase	Human	Suzuki <i>et al.</i> (1997)
Angiostatin	Murine	Wu <i>et al.</i> (1997)
Serotonin 5-HT <sub>7</sub> receptor	Murine	Obosi <i>et al.</i> (1997)
Replication factor C (hRFC)	Human	Cai <i>et al.</i> (1997)
Endothelial nitric oxide (eNOS)	Bovine	Ju <i>et al.</i> (1997)
Growth hormone receptor	Human	Bieth <i>et al.</i> (1997)
MAL	—	Puertollano <i>et al.</i> (1997)
Leptin receptor	—	Devos <i>et al.</i> (1997)
Insulin receptor substrate-1	Human	Algenstaedt <i>et al.</i> (1997)
Manganese-dependent superoxide dismutase	Human	Wright <i>et al.</i> (1997)
Parvovirus VP2 capsid protein	Porcine	Sedlik <i>et al.</i> (1997)
Varicella-zoster virus (VZV) glycoproteins E and I (heterodimer)	—	Kimura <i>et al.</i> (1997)
Hawaii calicivirus capsid protein	—	Green <i>et al.</i> (1997)
Cardiac Ca <sup>2+</sup> pump and phospholamban	Canine	Autry and Jones (1997)
Type IV collagenase/gelatinase	Human	George <i>et al.</i> (1997)
Eukaryotic initiation factor-2B (eIF-2B)	Human	Fabian <i>et al.</i> (1997)
Cellobiohydrolase	Fungal	von Ossowski <i>et al.</i> (1997)
Respiratory syncytial virus fusion protein	—	Parrington <i>et al.</i> (1997)

## Why this system?

1. Insect cells have almost the same posttranslational modifications as mammalian cells
2. Higher expression level than mammalian cells

# Mammalian cell expression system

## 1. Why do we use that system?

-> to get full complement of posttranslational modifications on proteins

## 2. Developed cell lines:

-> short term (transient) expression -> autonomous replicating systems -> viral origins (SV40)

- African green monkey kidney (COS)

- baby hamster kidney (BHK)

- human embryonic kidney (HEK-239)

-> long term (stable) expression -> integration into chromosome -> viral origins

- chinese hamster ovary (CHO)

# Mammalian cell expression system

**Table 3**

Comparison of Sindbis Virus and Other Viral Expression Systems

	Sindbis virus	Retrovirus	Adenovirus	Baculovirus
Expression	Transient	Stable	Transient	Transient
Expression level	High	Depends on integration site	High	High
Construction	Plasmid construction	Requires use of cell line	Requires recombination	Requires recombination and plaque purification
Tropism	Wide	Depends on packaging cell line	Variable	Insect cells
Infection efficiency	High	Variable	Variable	High
Host protein shutoff	Yes	No	Yes	Yes

## Gene expression in mammalian cell lines

*A convenient alternative for setting up mammalian cell facilities - get a comprehensive service from us. We will achieve stable expression of the gene of your interest in mammalian cells.*

### **Customer provides:**

- Mammalian vector with the gene (cDNA) to be expressed. We accept plasmid and retroviral vectors
- Sequence of the gene and map of the construct for transfection
- Cell line or information about the cell line to be transfected.

### **Our service includes:**

- Transfection of the cells. In case of a retroviral vector, virus production and cell infection
- Antibiotic selection and generation of stable transfected (infected) cell clones. At least 10 independent clones will be selected and grown
- Quantitative assay of the gene (cDNA) expression level in each transfected clone by RNA isolation followed by Northern hybridisation and/or RT-PCR
- Selection of the best expressing clone
- Cell freezing and depositing
- Duration: 3-6 months (depending on the cell growth rate), allow 1month in addition if the cell line is not available in our collections

### **Customer receives:**

- Detailed report on experiments and data obtained.
- Two vials of transfected cells (the best expressing clone)
- We will deposit the transfected cells in our collection as a precaution against accidental loss of the clone.

### **Price guide:**

Price per transfection and selection of at least 10 clones: £3500.



# Competitiveness of different expression systems

WORST

BEST

