

CHRISTMAS



We wish you a Merry
Christmas...



Answer the questions:

❖ When is Christmas Day?

❖ How do people decorate the Christmas tree?

❖ Where do people put Christmas presents?



❖ **Where do children put their stockings when they go to bed?**

❖ **Who comes at night?**

❖ **What is there in Father Christmas bag?**

❖ **Where does he put Christmas presents for children?**

❖ **What is Boxing Day?**



True or False:

	True	False
❖ Every year there is a big Christmas tree in Trafalgar Square. This is a present from Norway.		
❖ American people send a tree as a present.		
❖ There are no people in the shops on Christmas Eve.		
❖ The shops are busy on Christmas.		



❖ People buy presents on Christmas		
❖ People don't buy presents for their family and friends.		
❖ The English open their presents on Christmas Eve.		
❖ People open their presents on Christmas morning.		
❖ For Christmas dinner people eat turkey and the Christmas pudding.		
❖ For Christmas dinner people eat pizza and hamburgers.		



ch=m

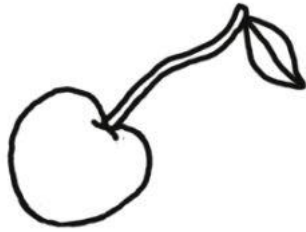

1 2 5 4

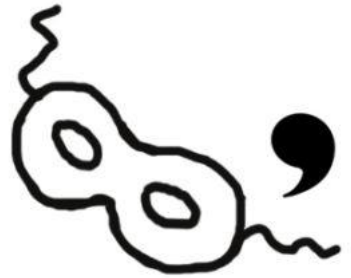
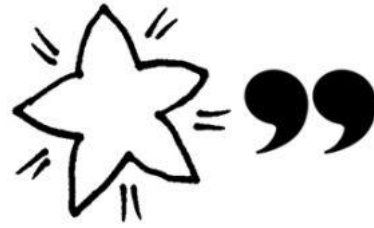

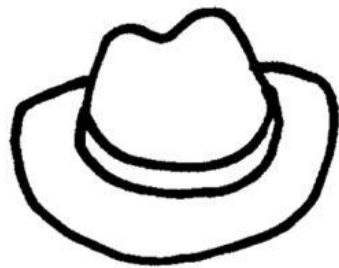

,

“



t=wy

OL



u=a

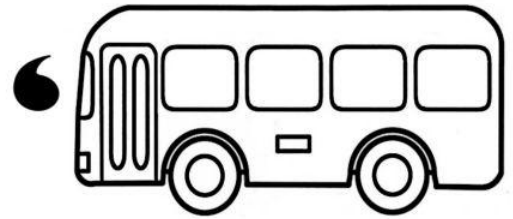
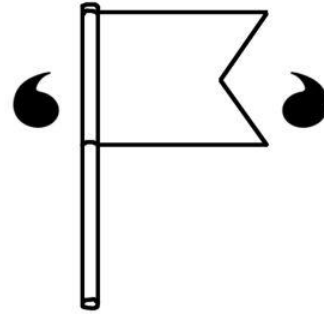
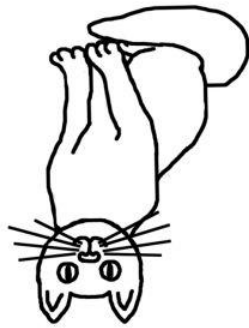
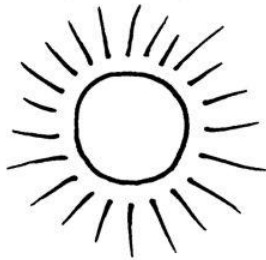

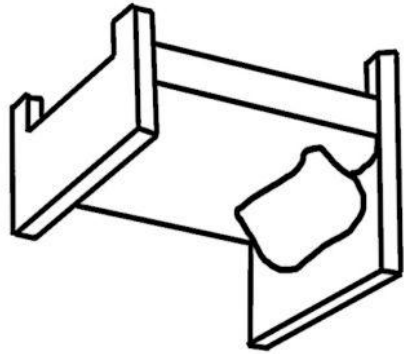

,

a=0

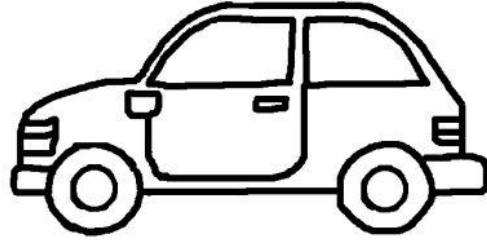

3 4 2



1 4 2 5 2

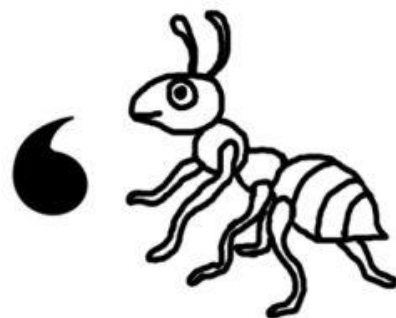
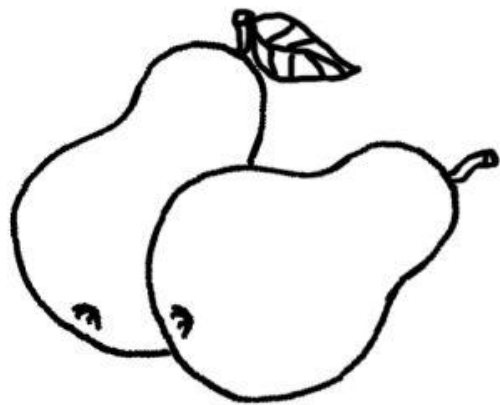

Thank you very much!!!

