

КОНСТАНТИН ЭДУАРДОВИЧ ЦИОЛКОВСКИЙ

БИОГРАФИЯ И ДОСТИЖЕНИЯ



Семья Константина



Астролябия

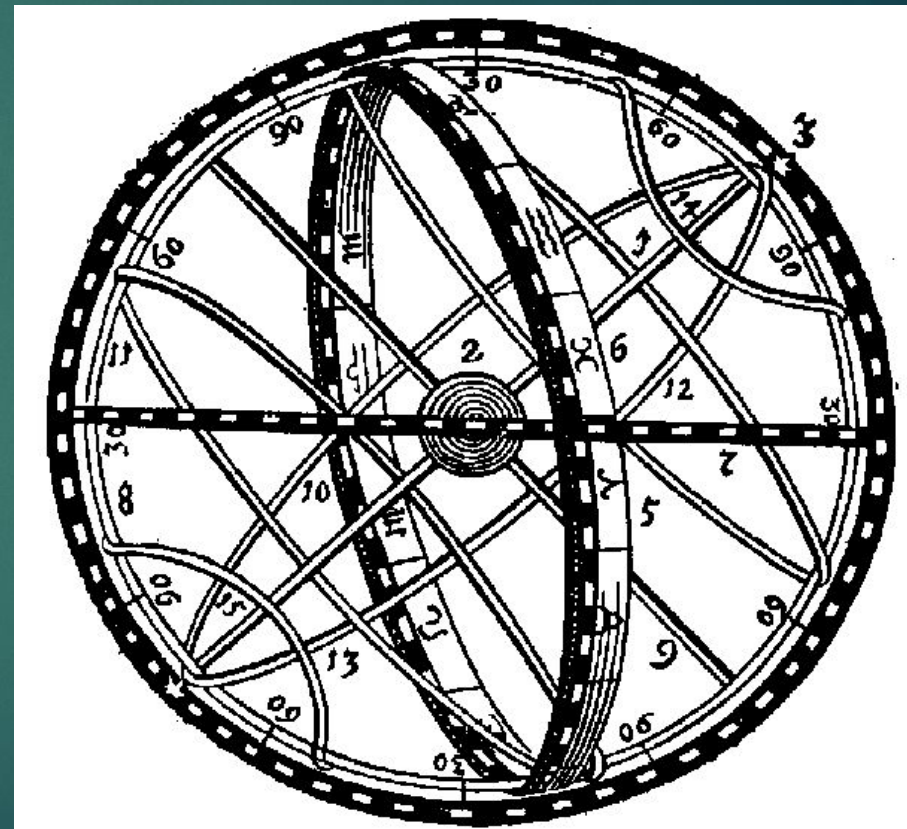
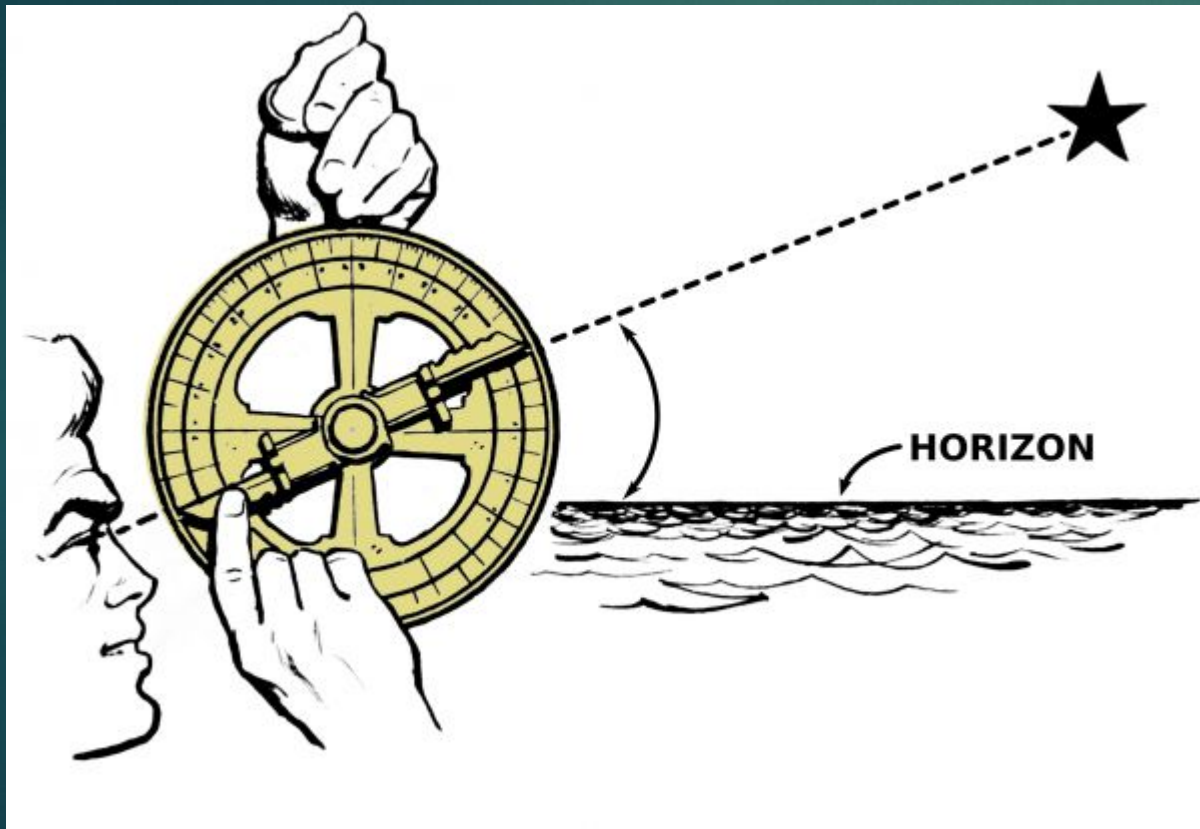

Наставник, заменивший учителя

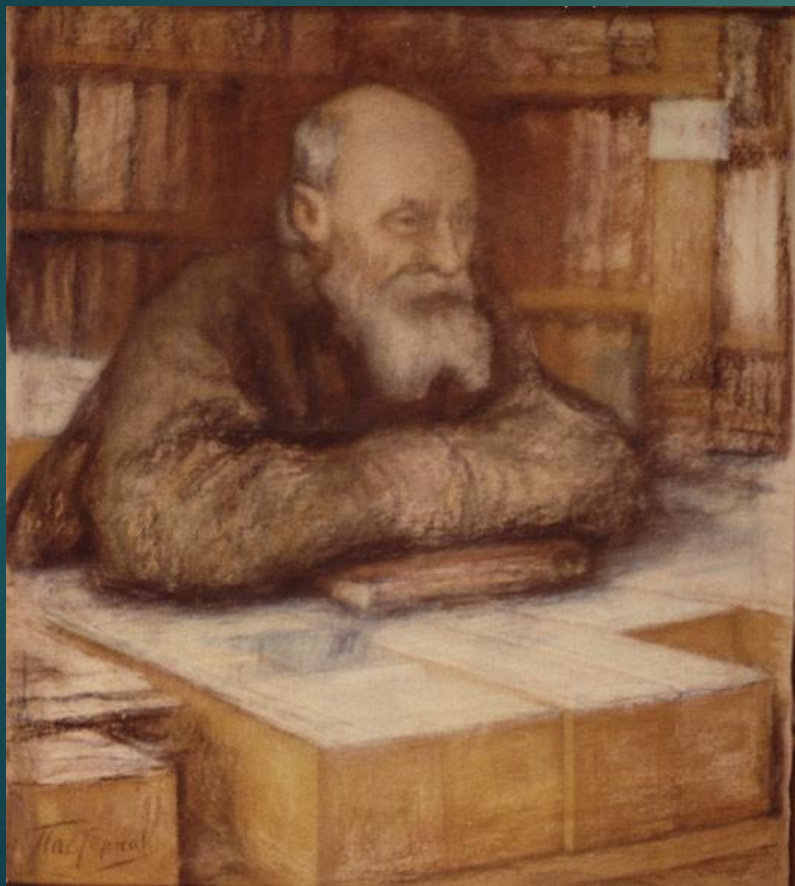

Воздухоплавание

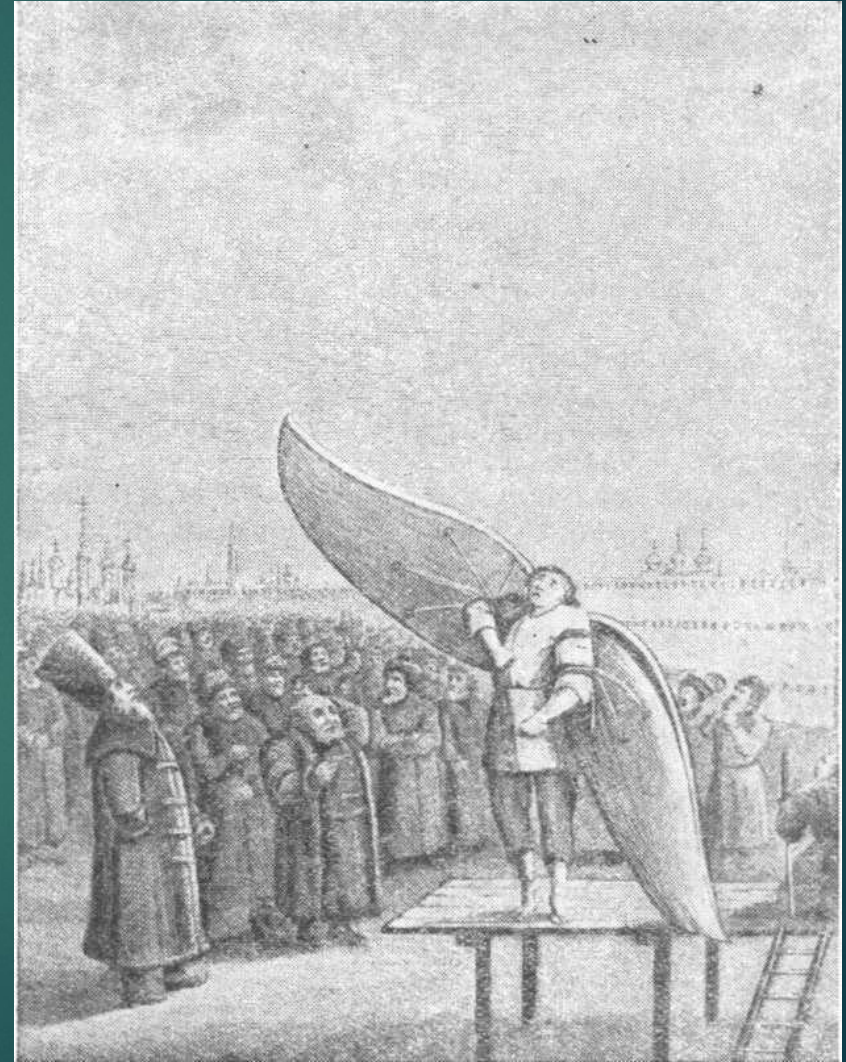
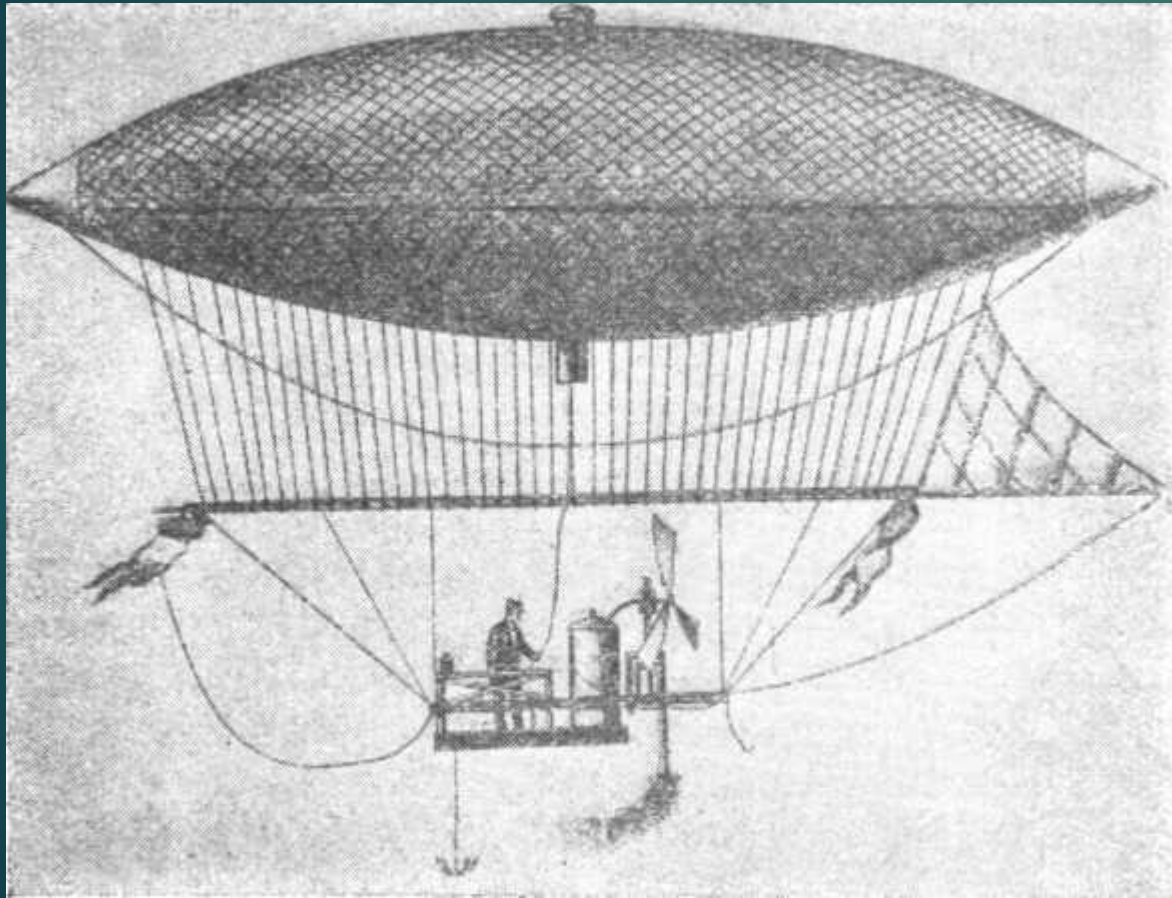

Работа над «дирижаблем»

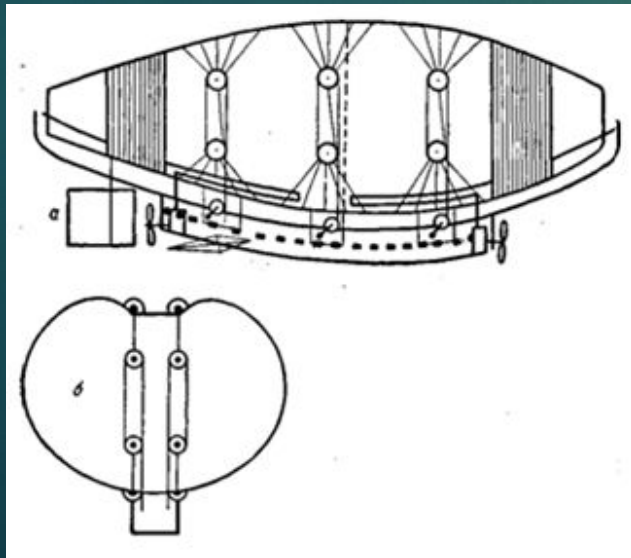

Моноплан Циолковского

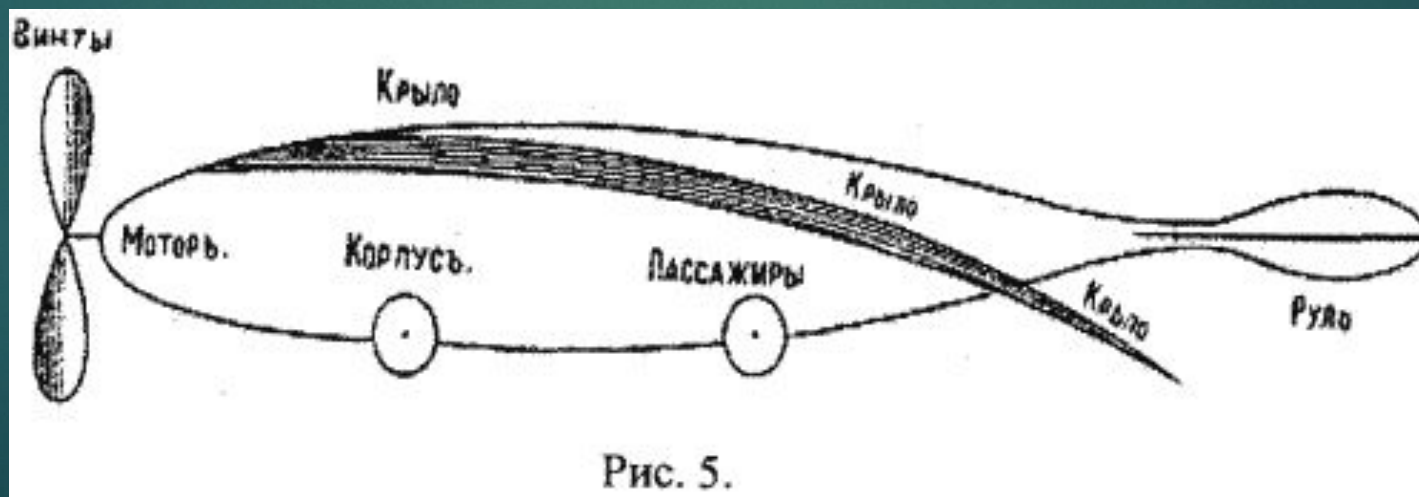
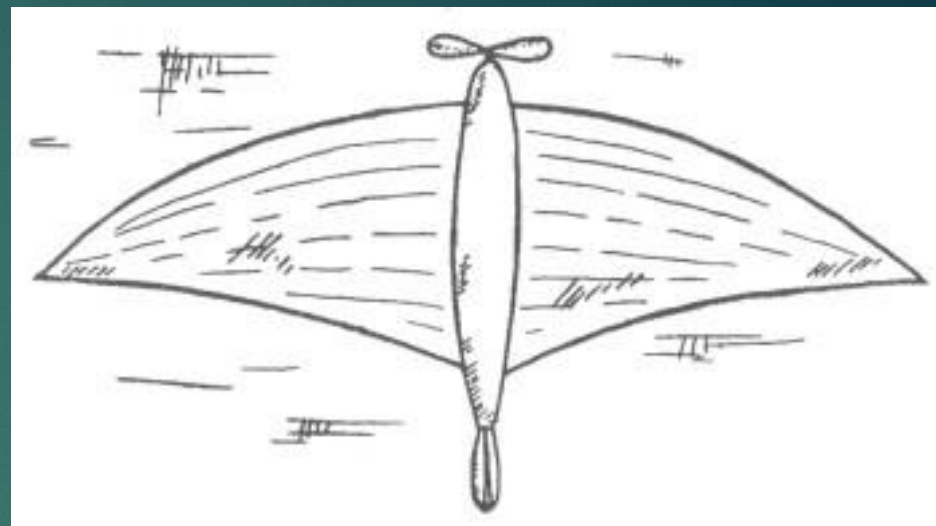
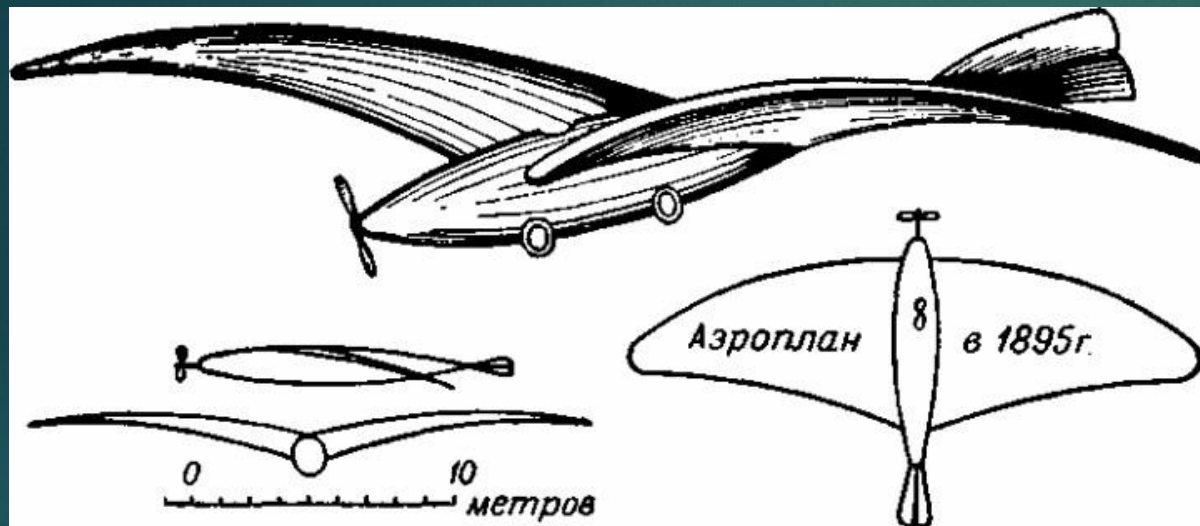

Аэродинамика

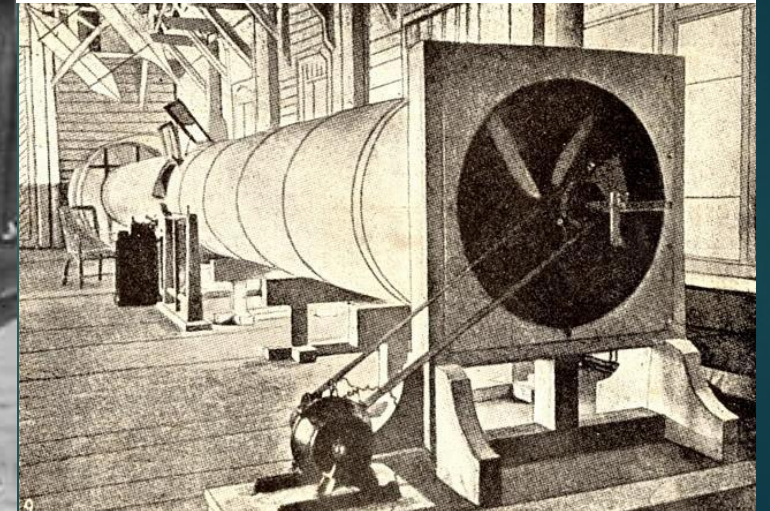
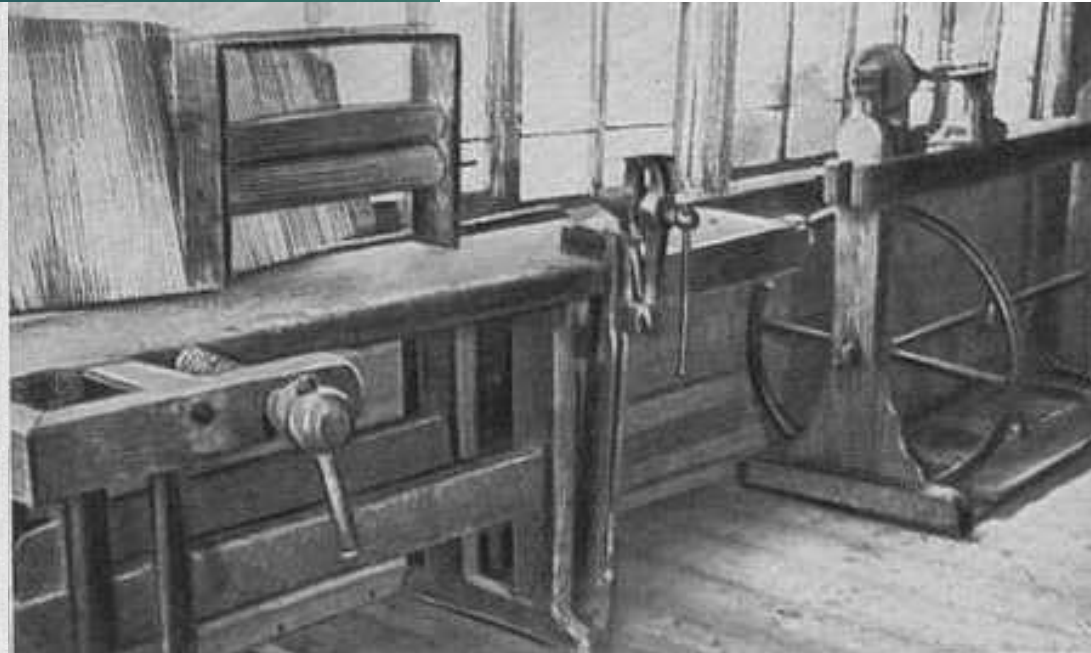
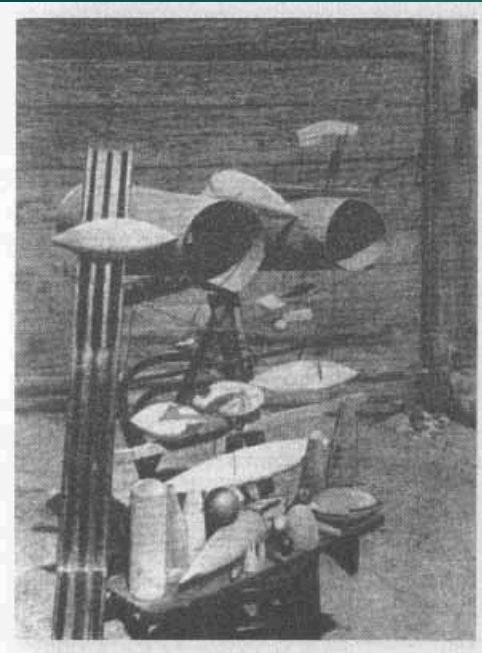
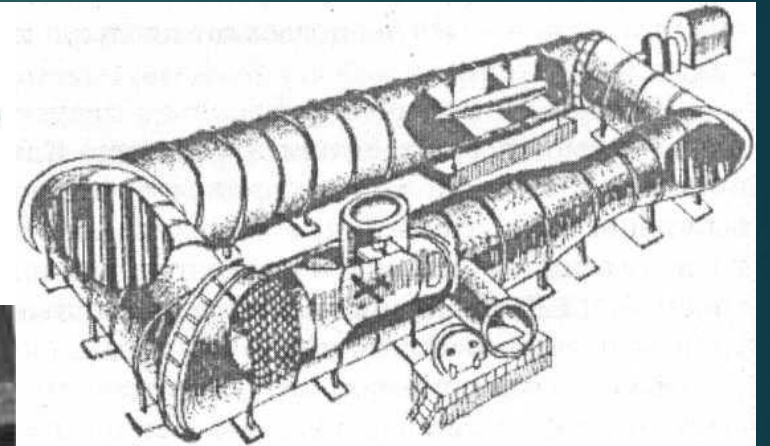
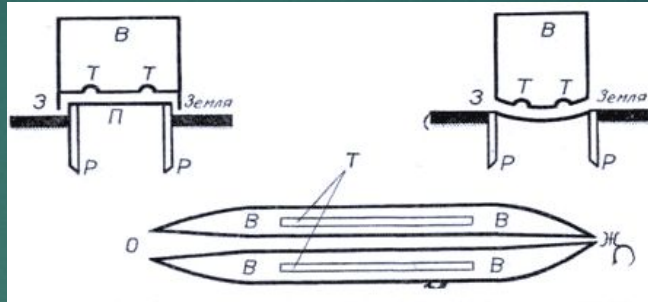

Ракетодинамика

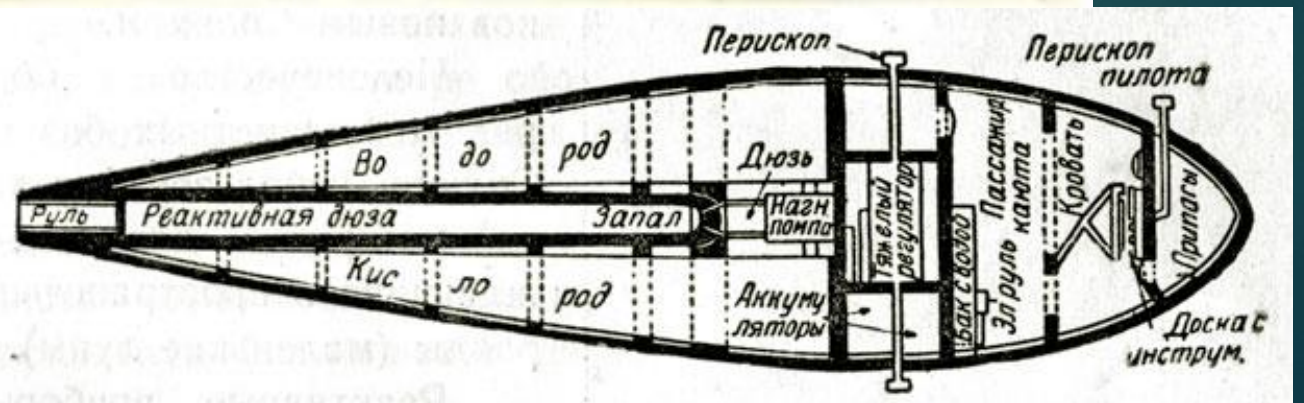
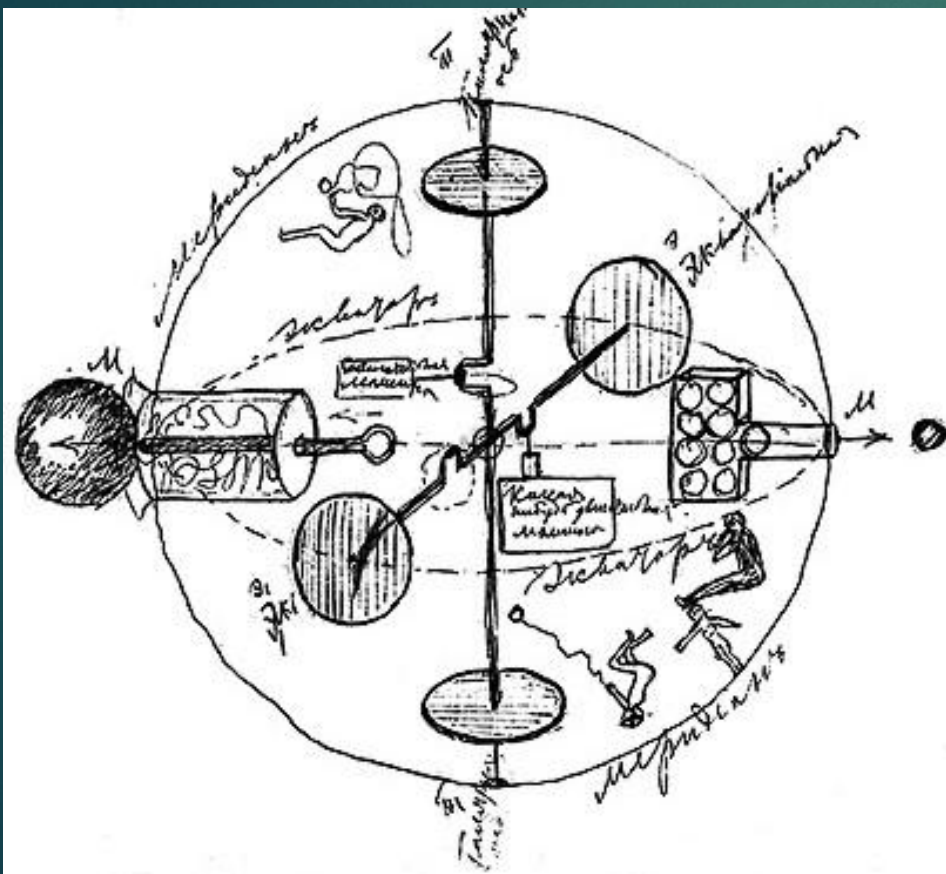

Ракета дальнего действия

$$W_x = I_0 \ln \left(\frac{M_1}{M_0} \right)$$

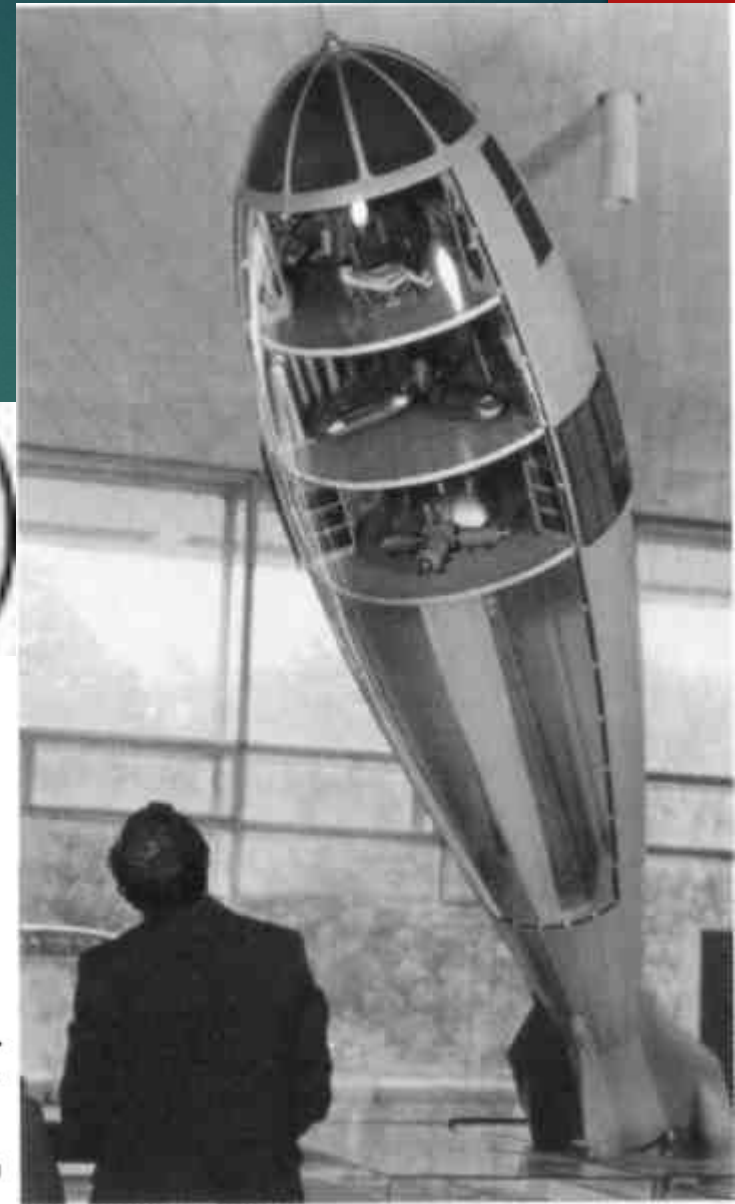
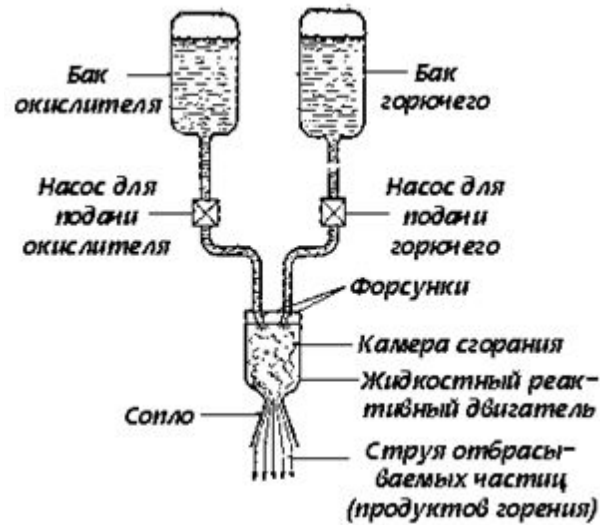
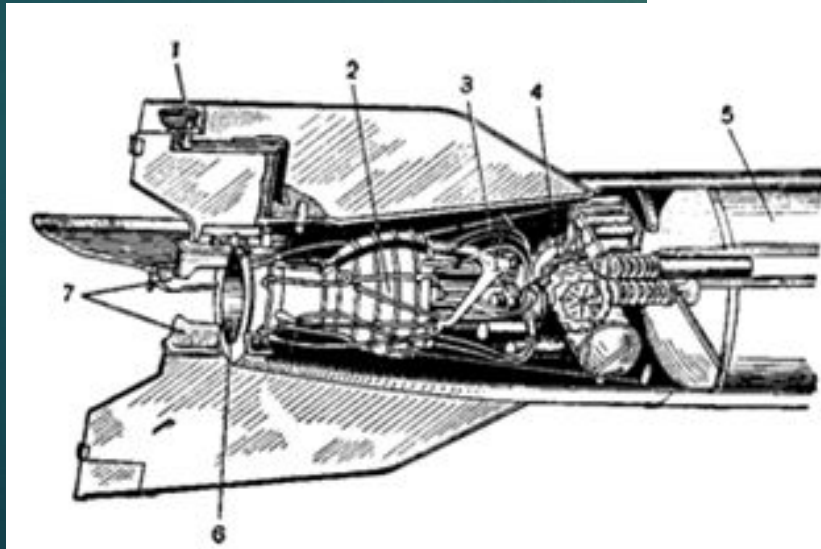

«Ракетный поезд»

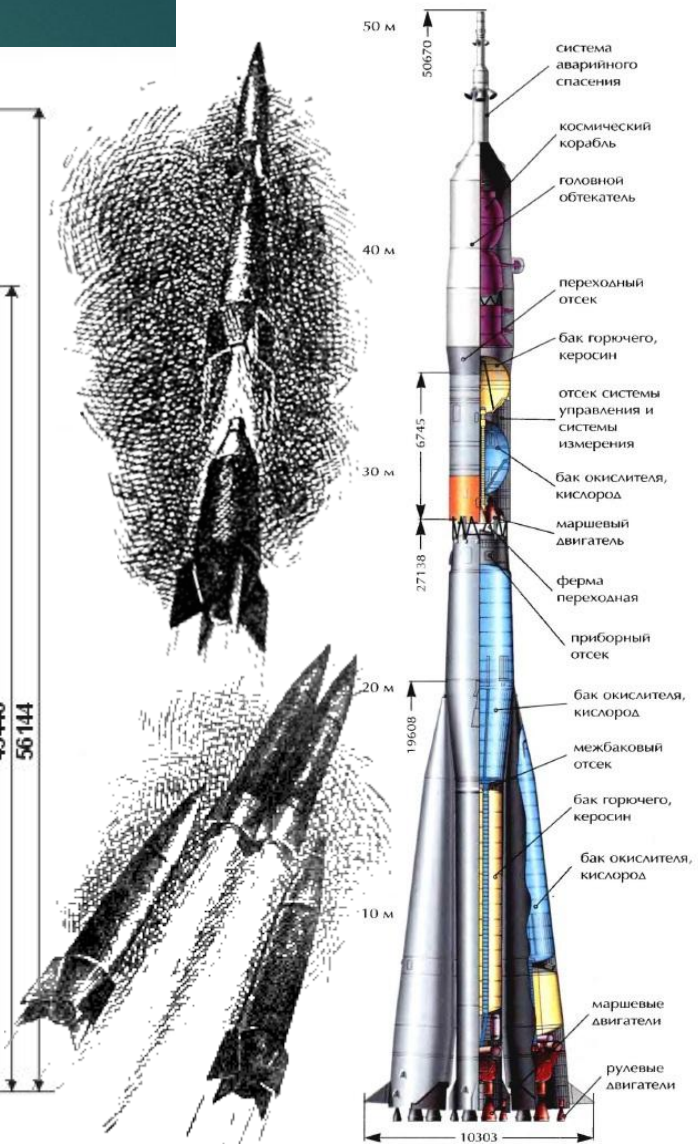
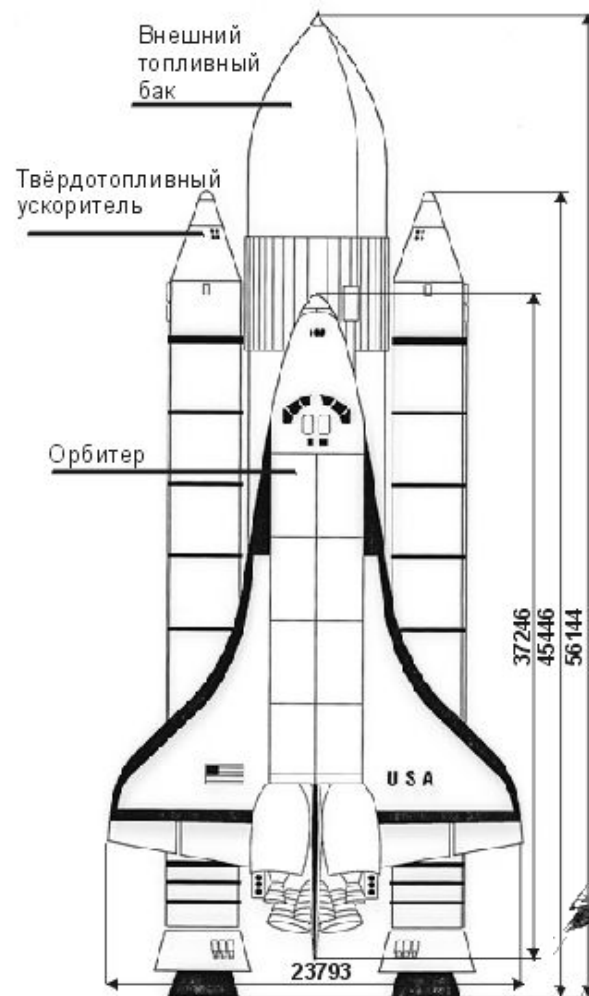
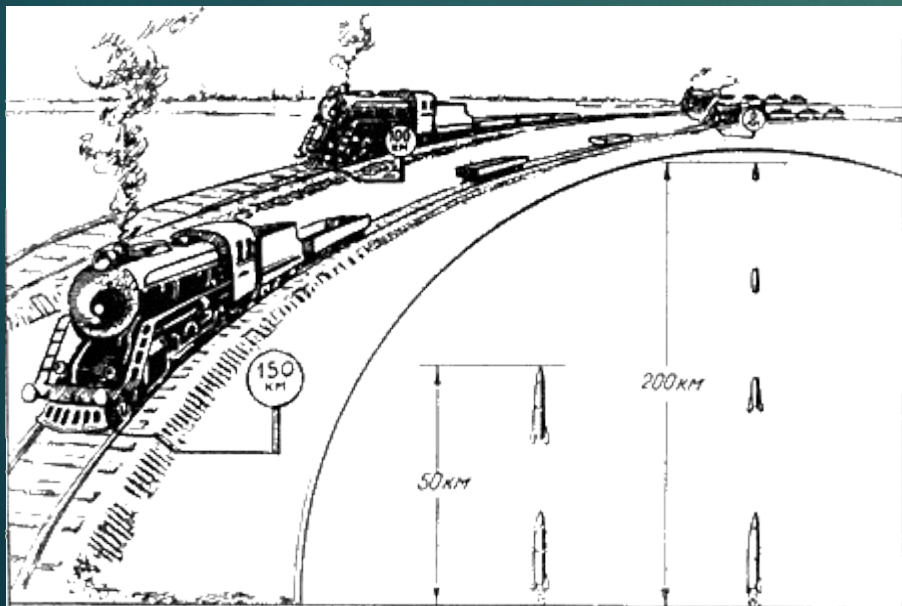

Грезы о Земле и небе

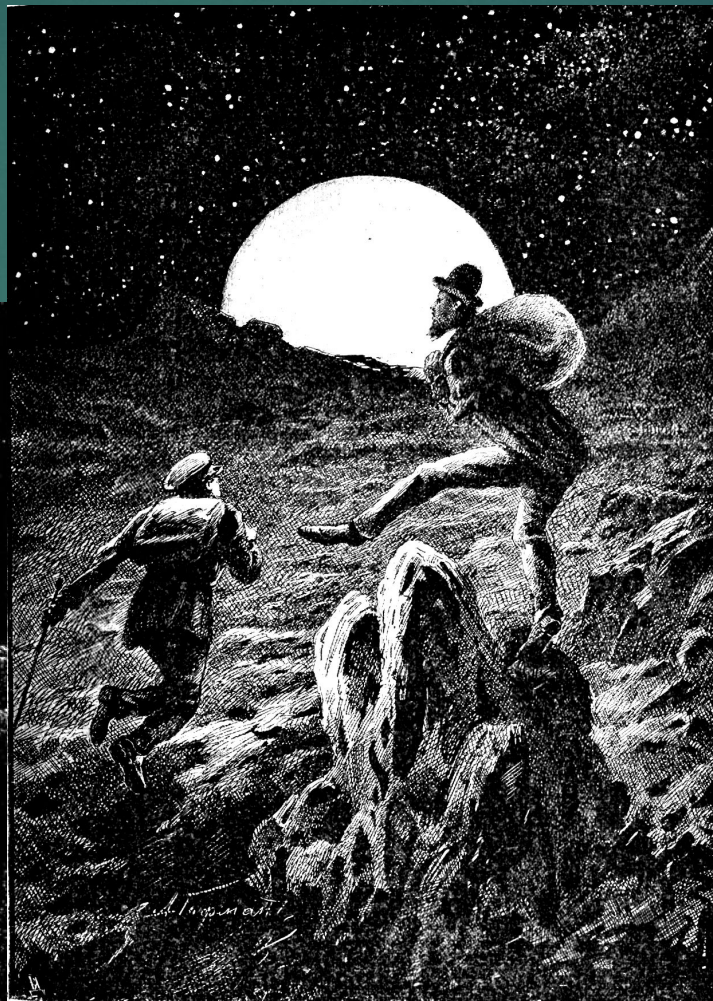

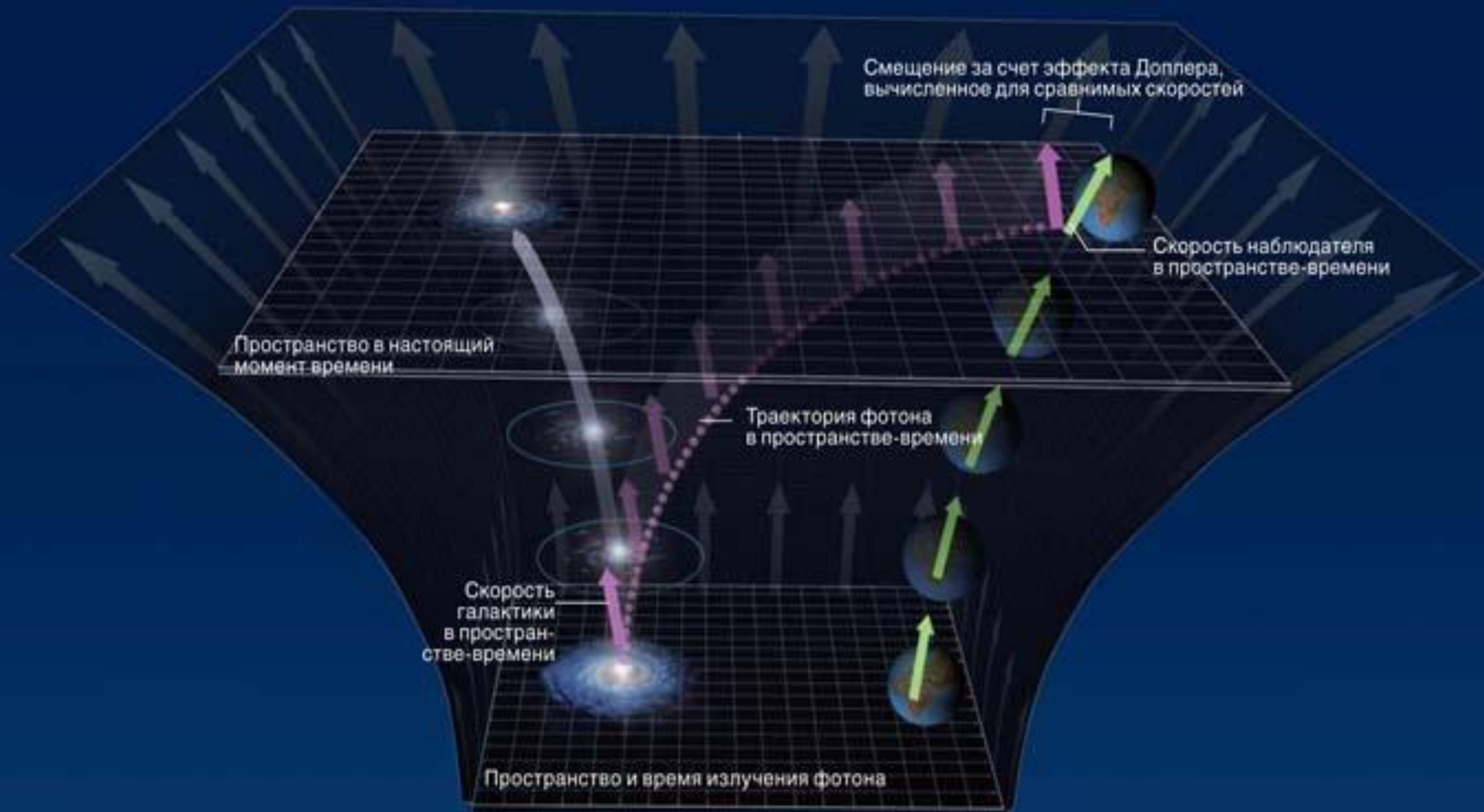

Философия

