

Трёхколёсный бот









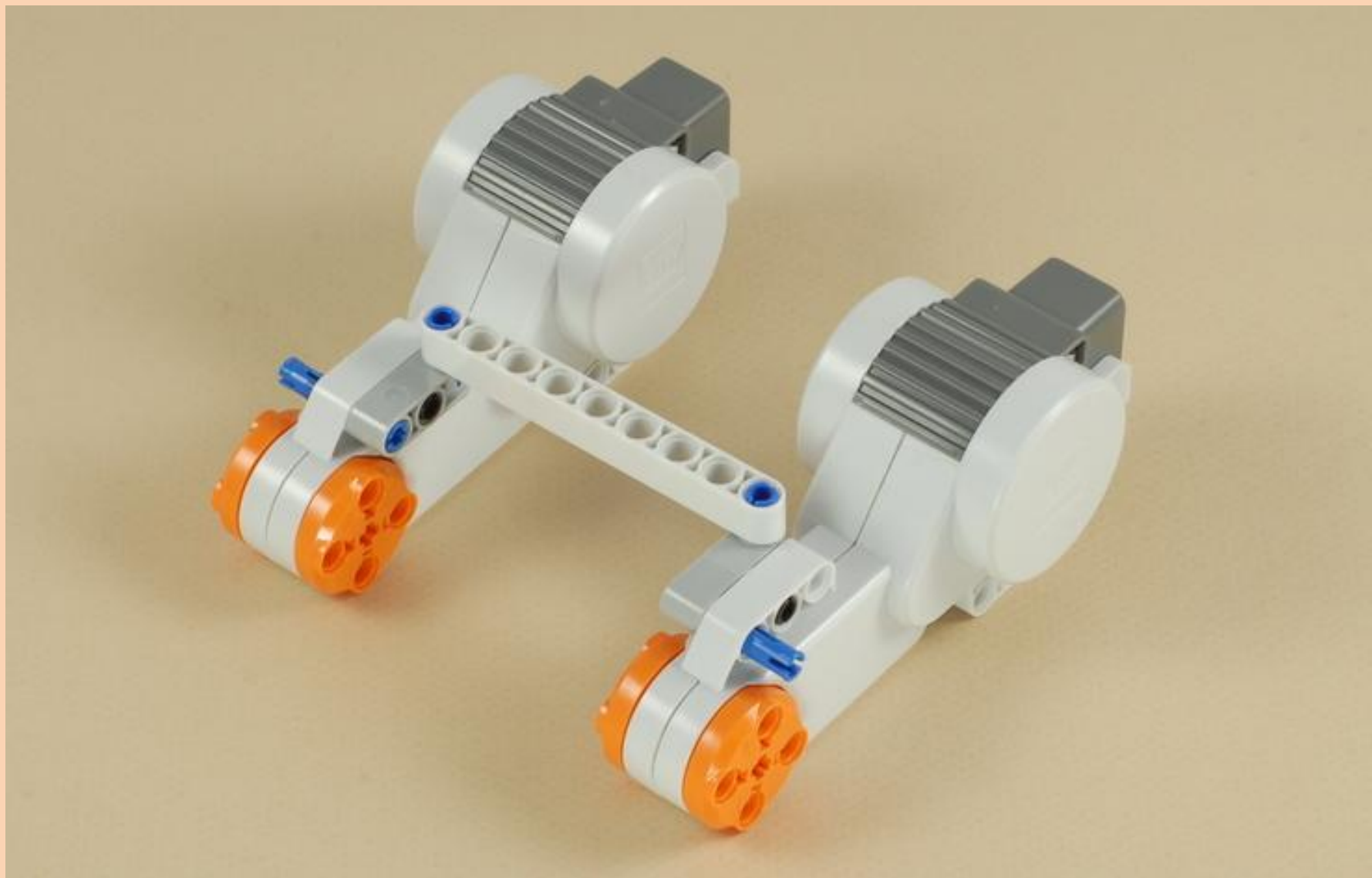

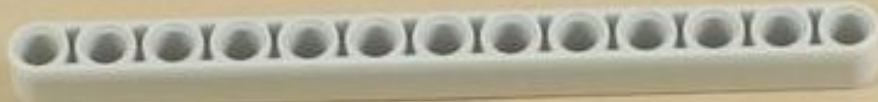

13

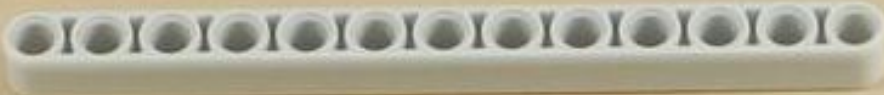
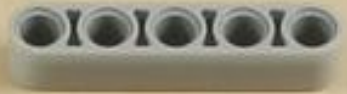

13

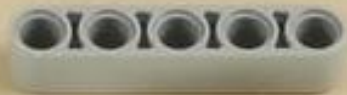

13



(10 x)



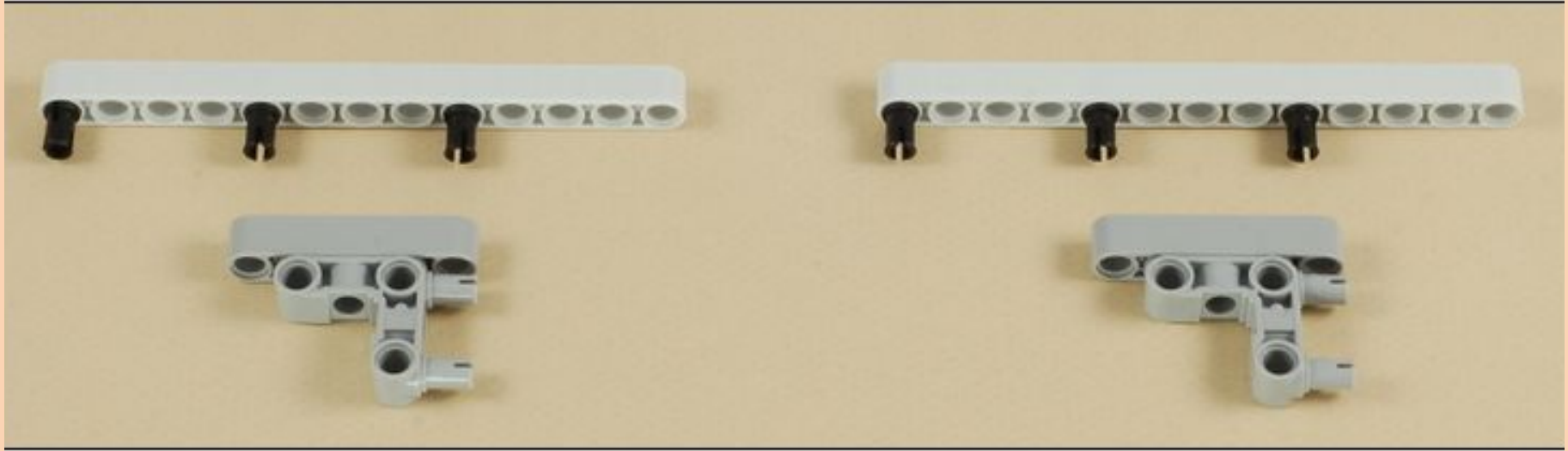

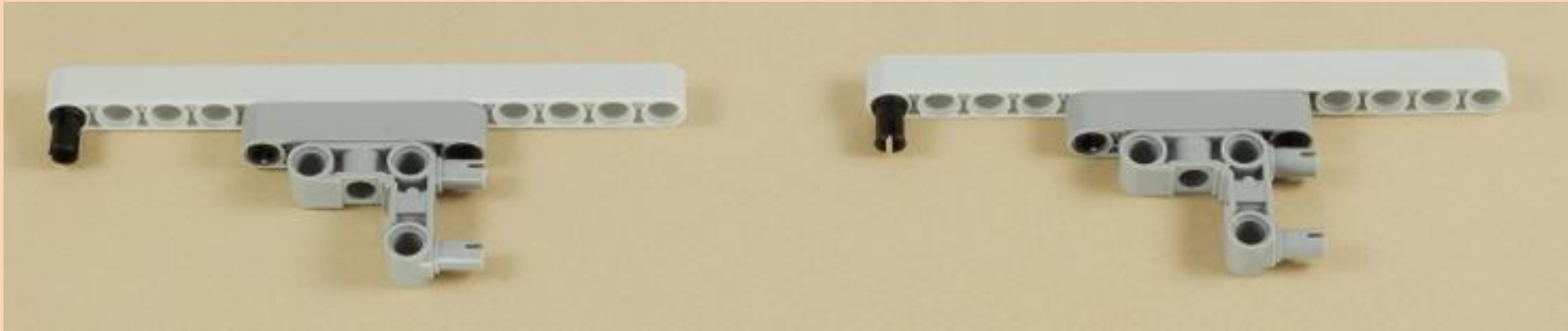

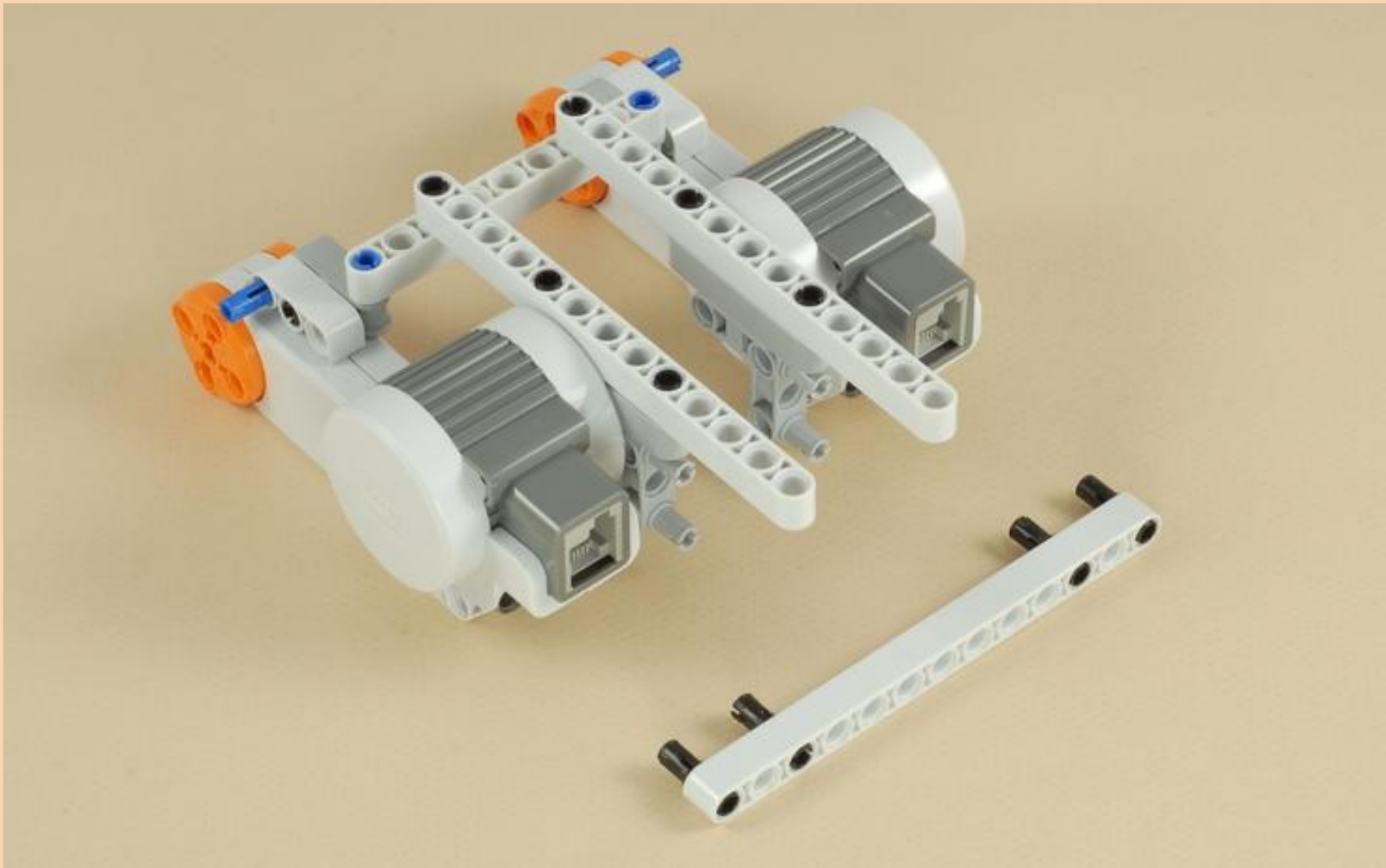

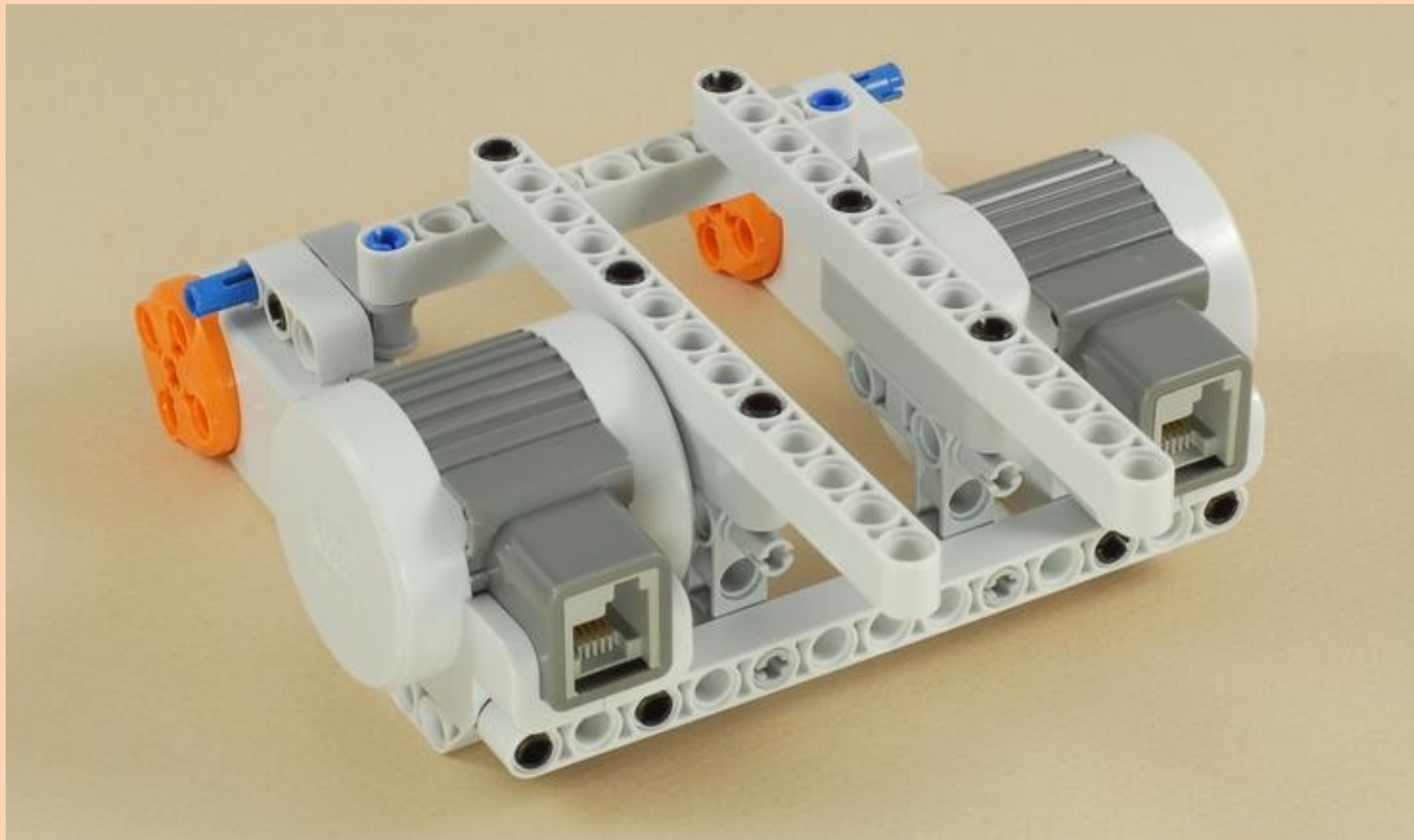

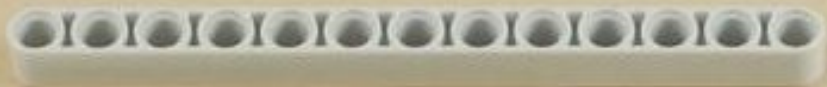

13

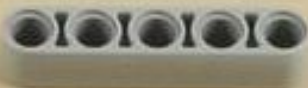

9

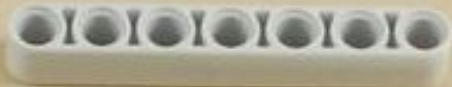

7

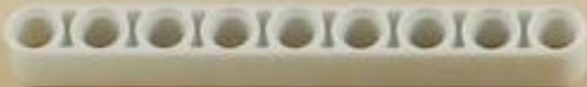

9

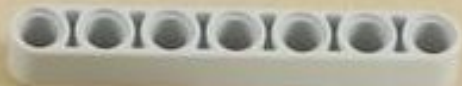

7



(11 x)



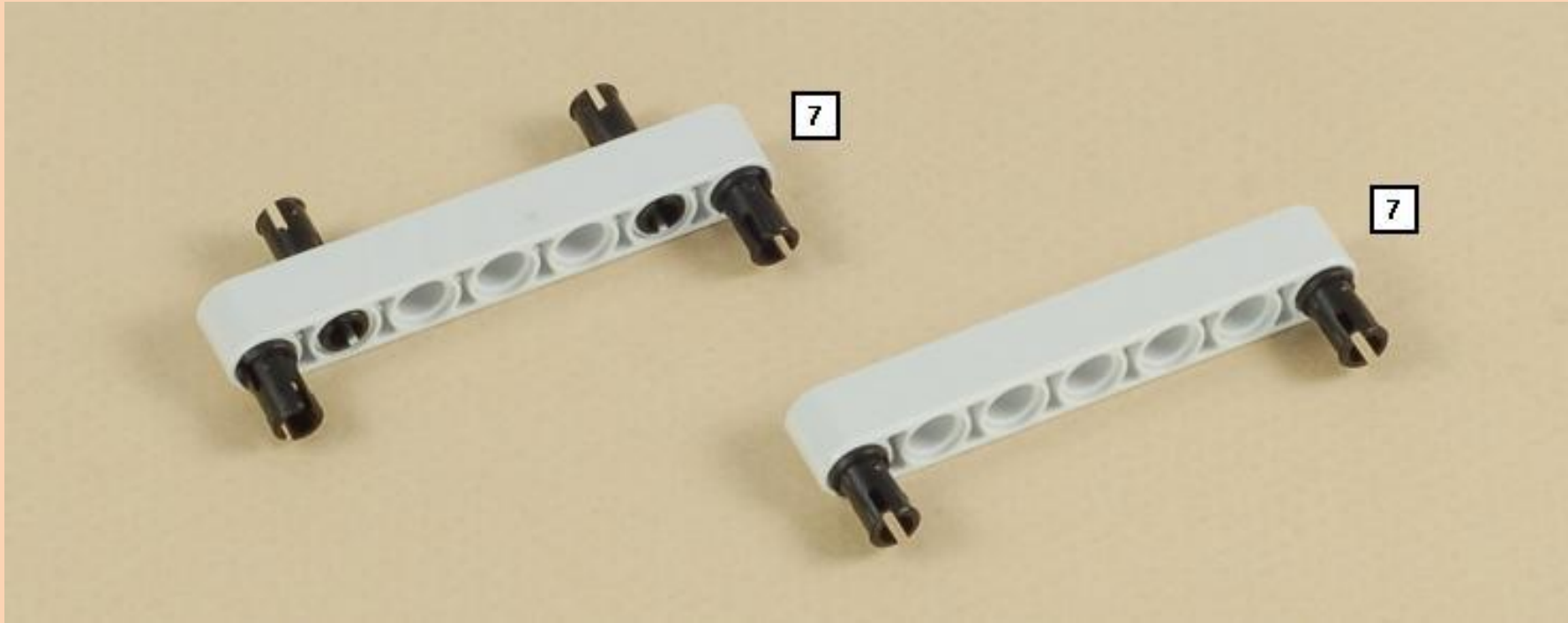



13

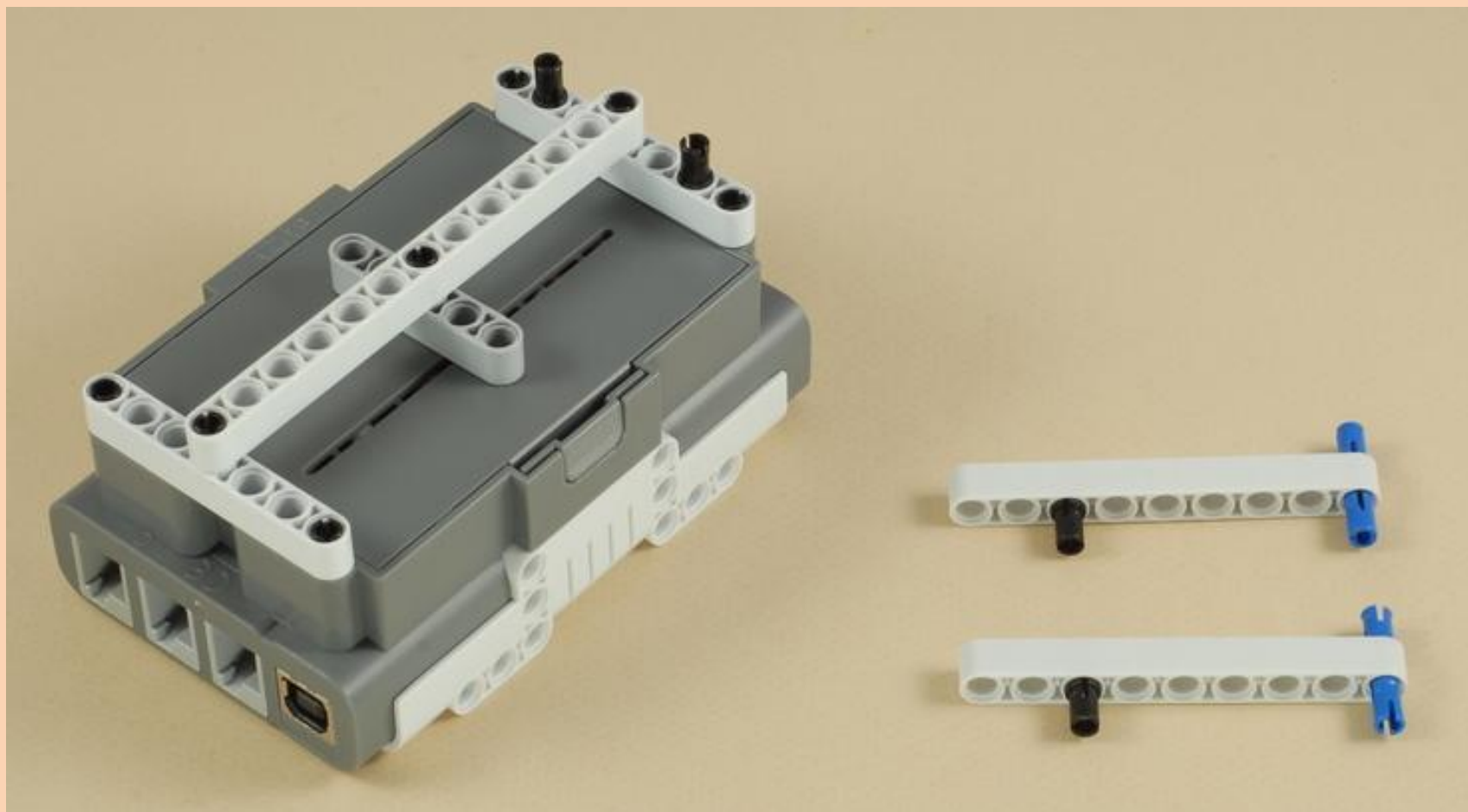

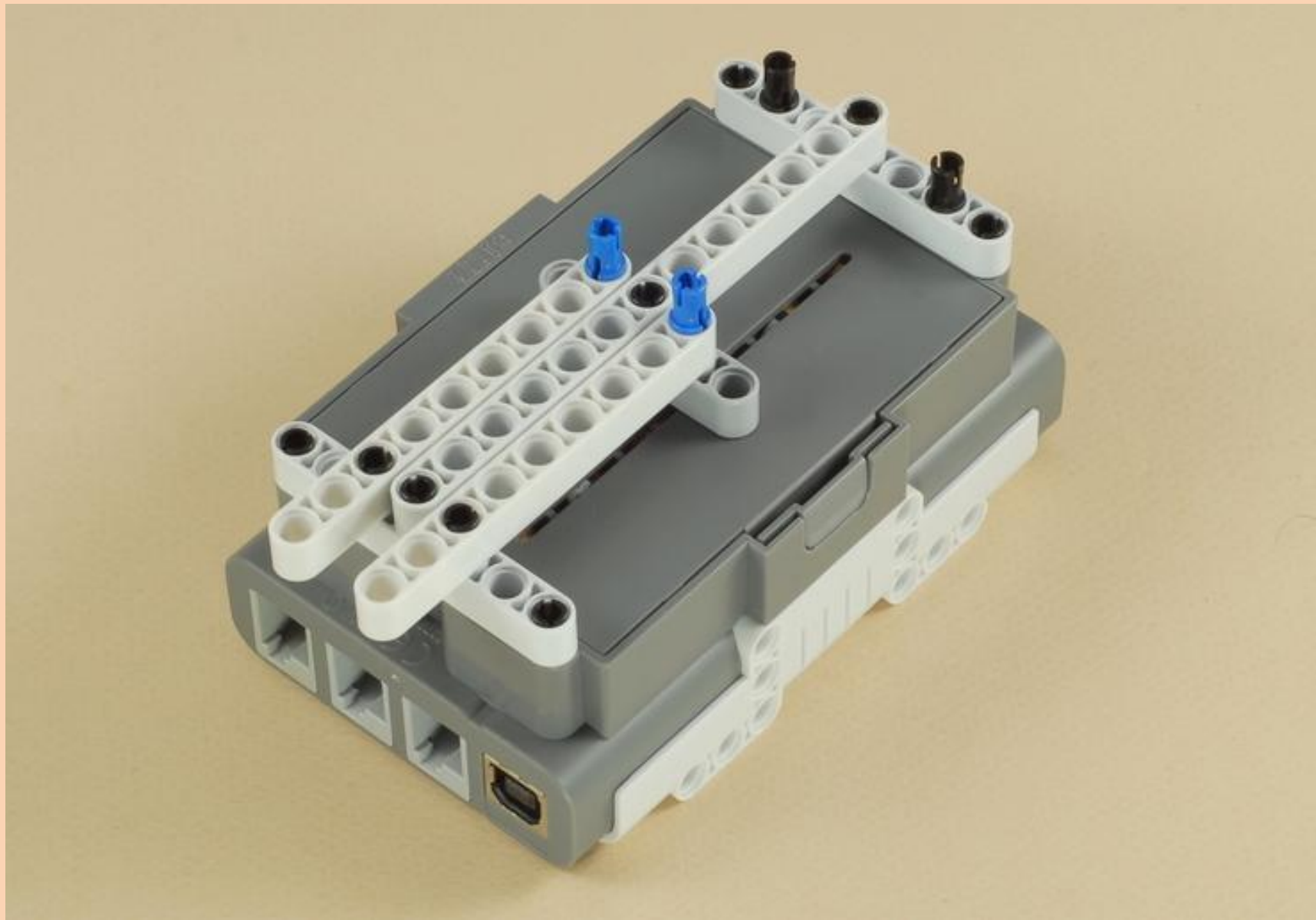

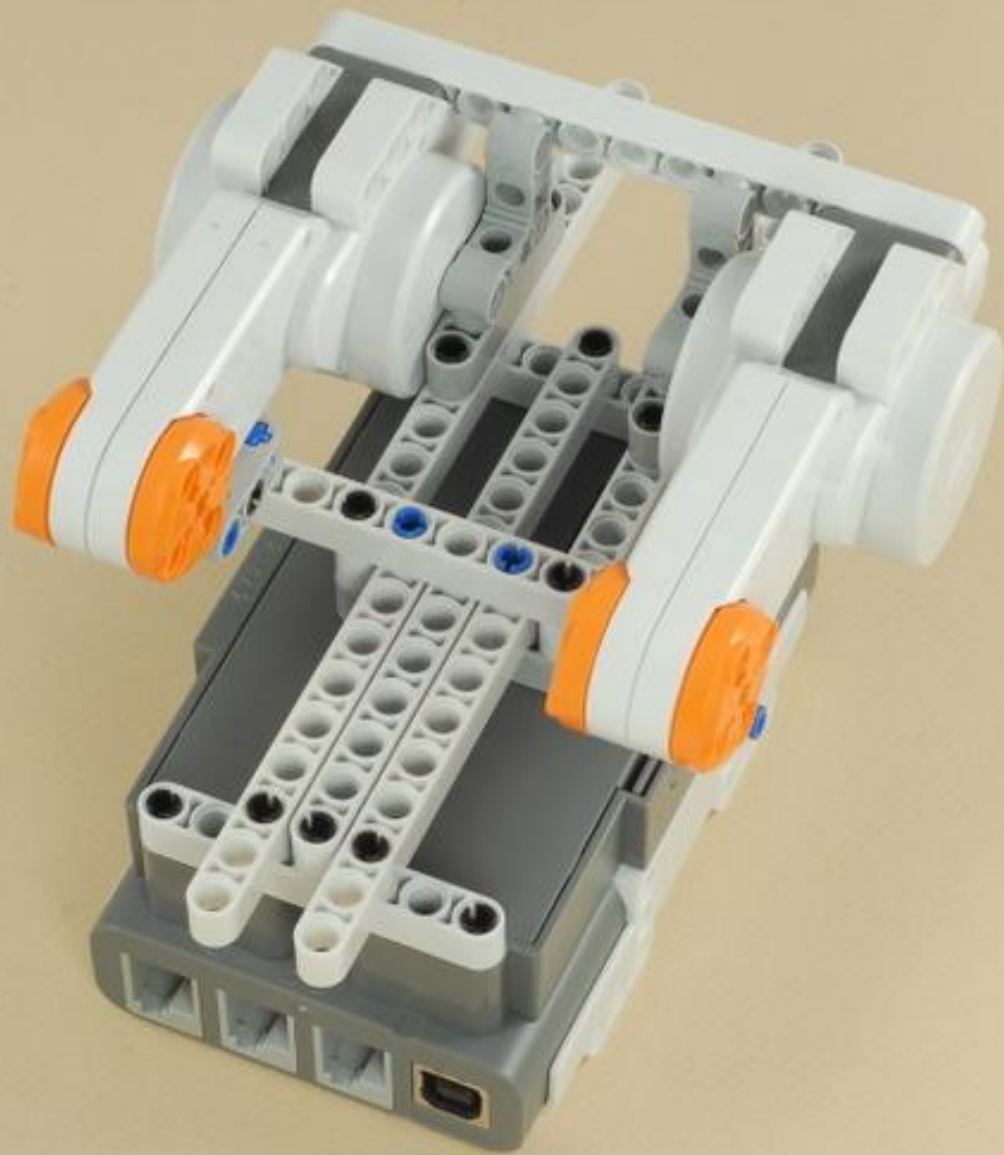

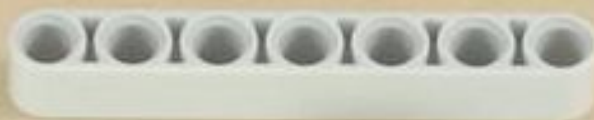
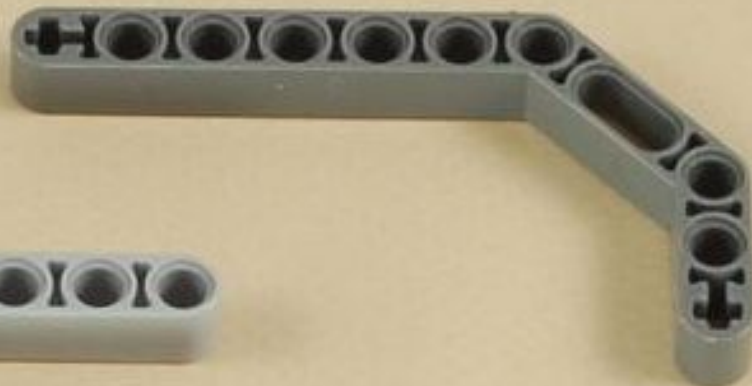

7



(9 x)



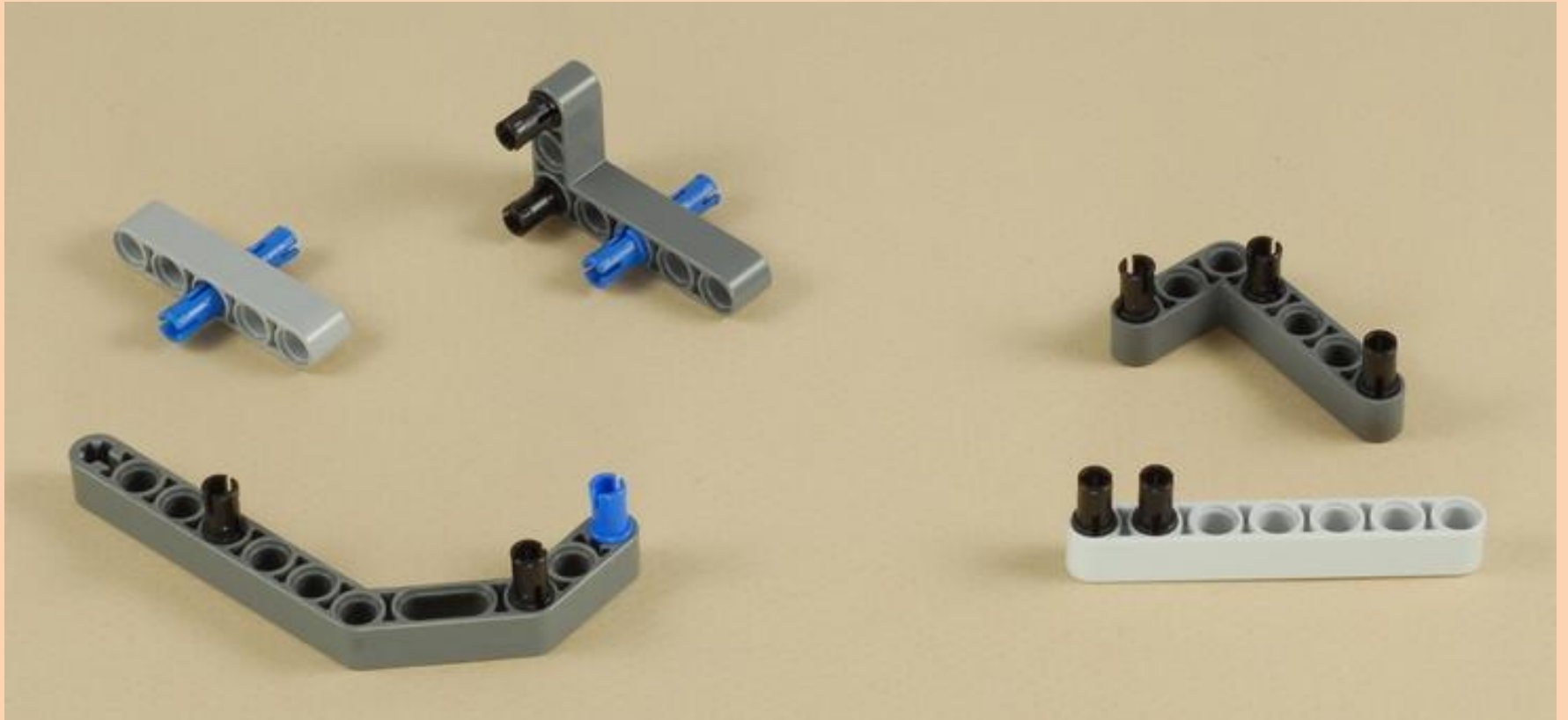

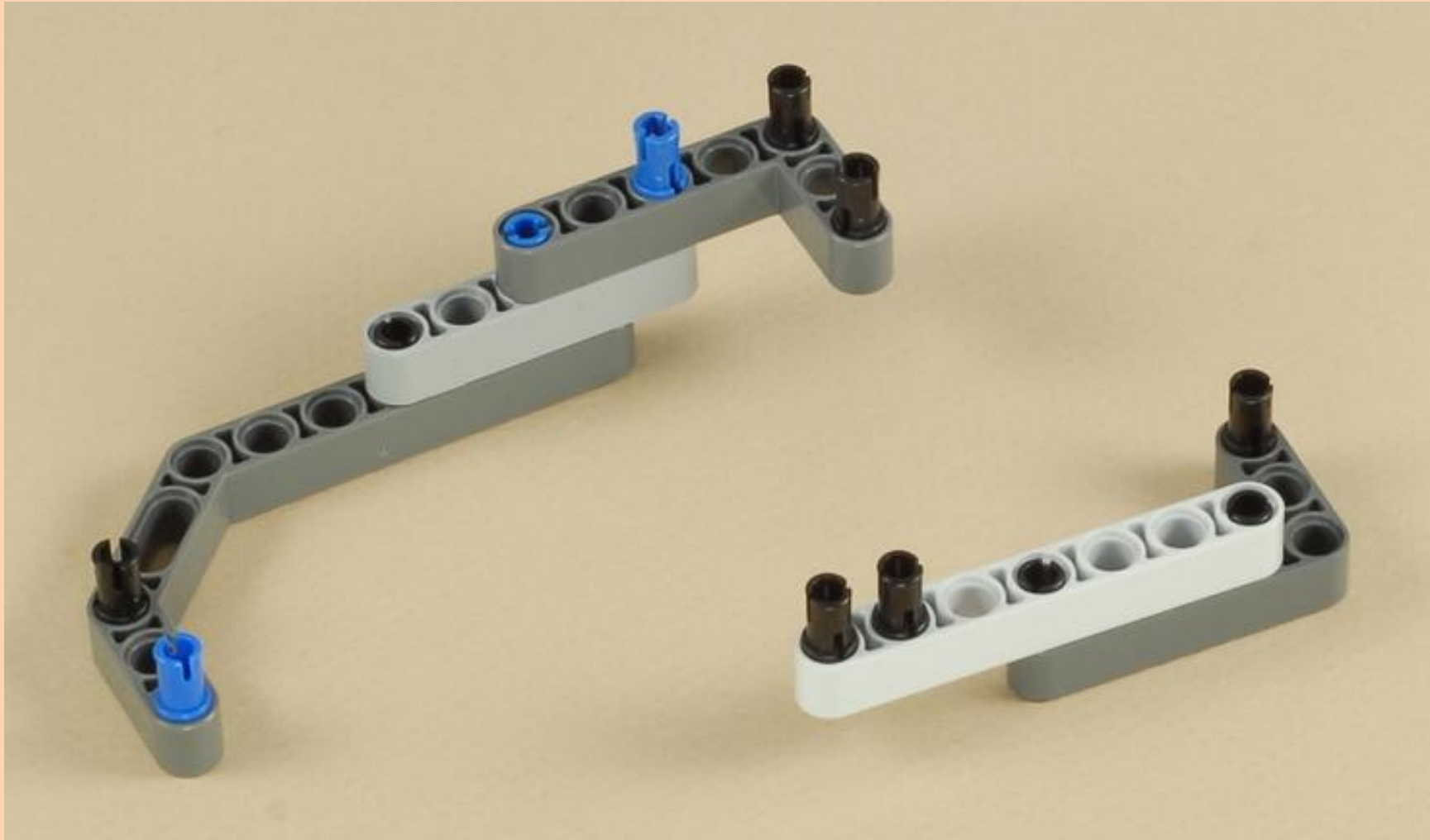



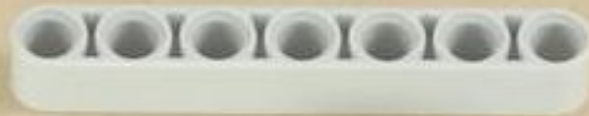
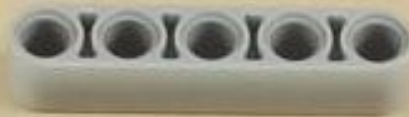
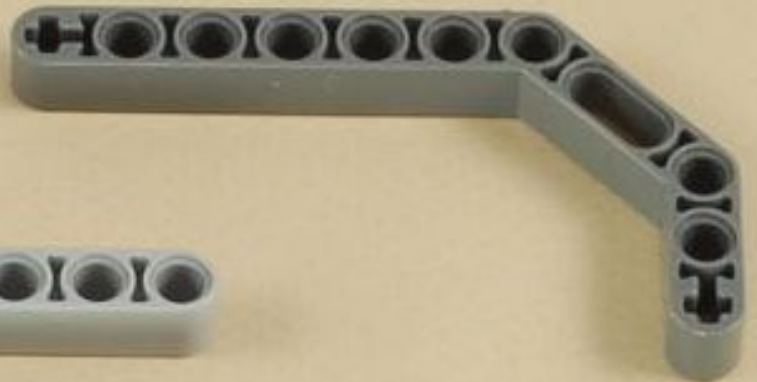

7



(9 x)



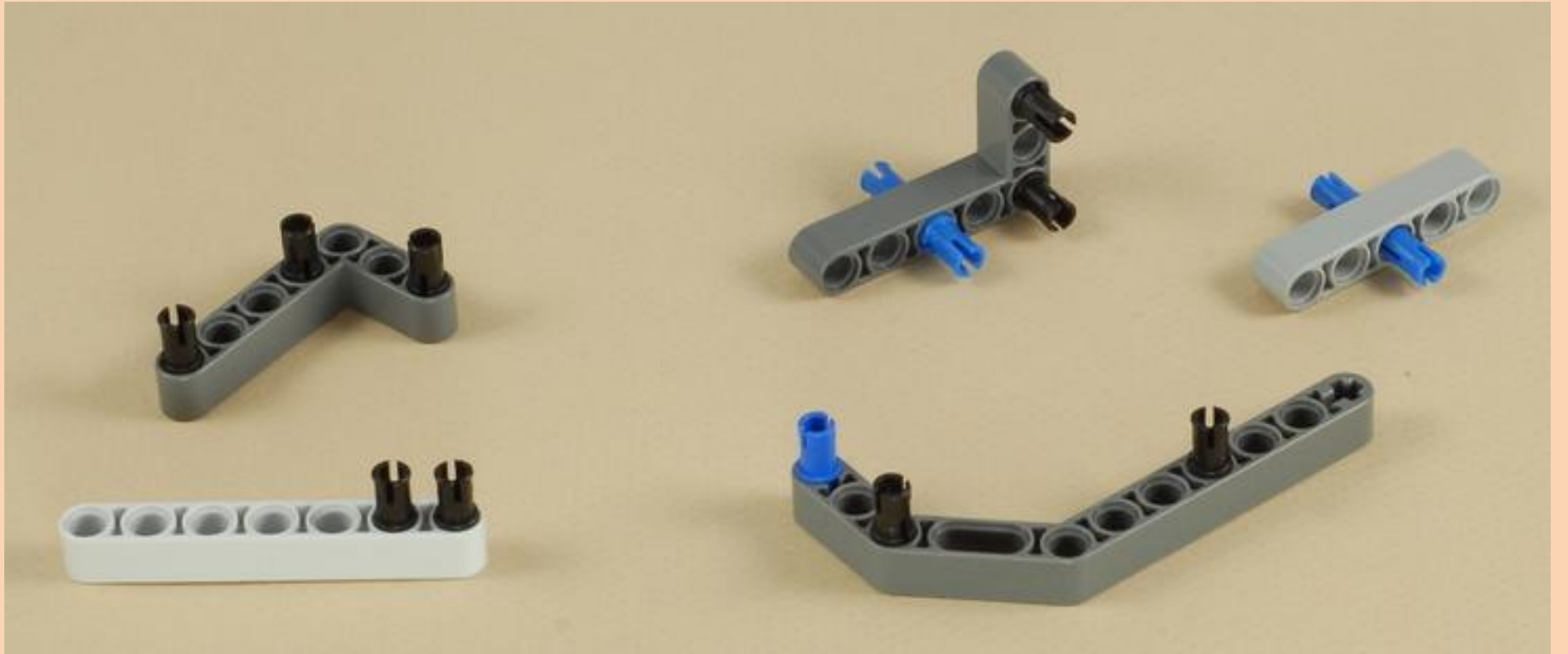

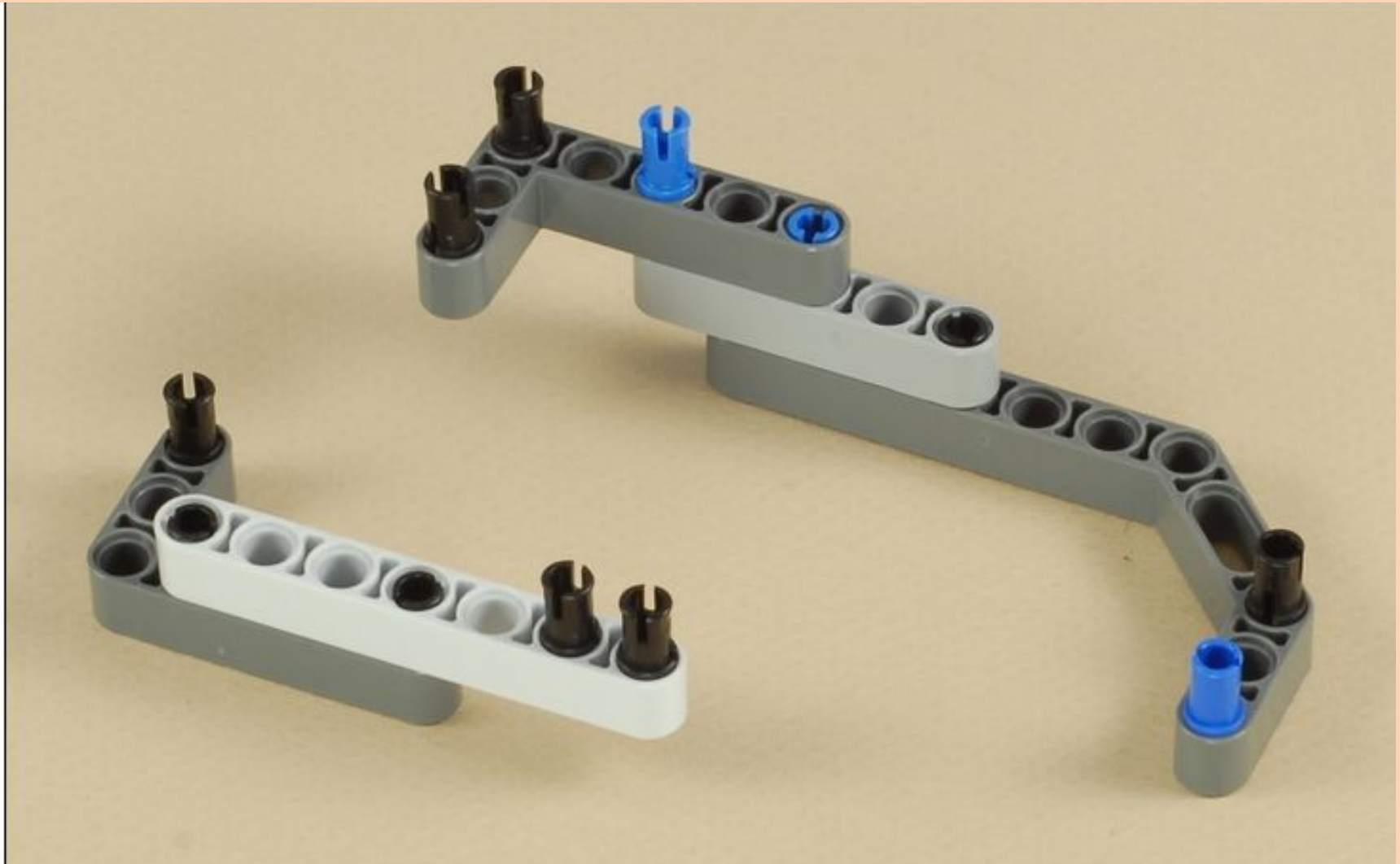

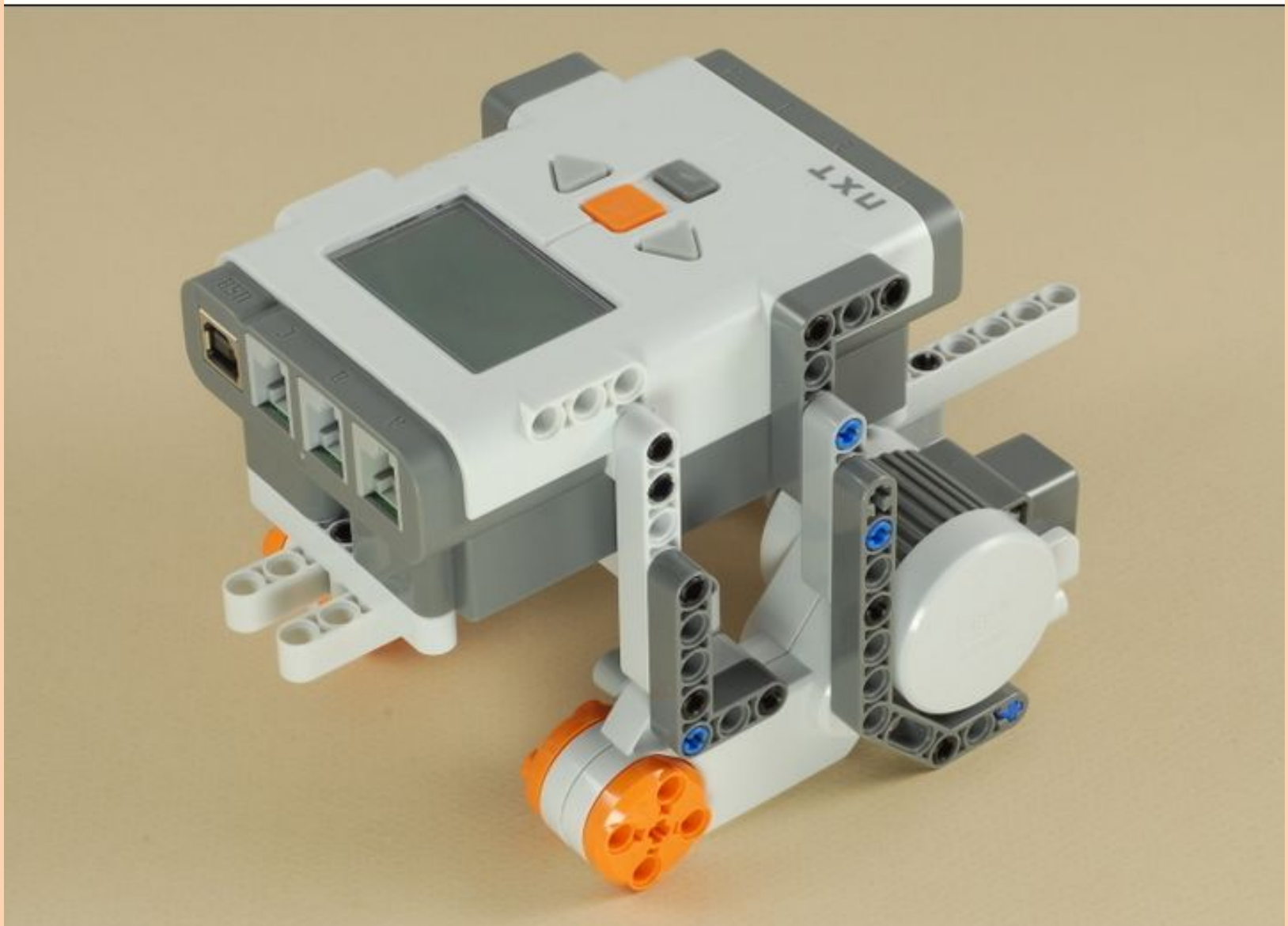

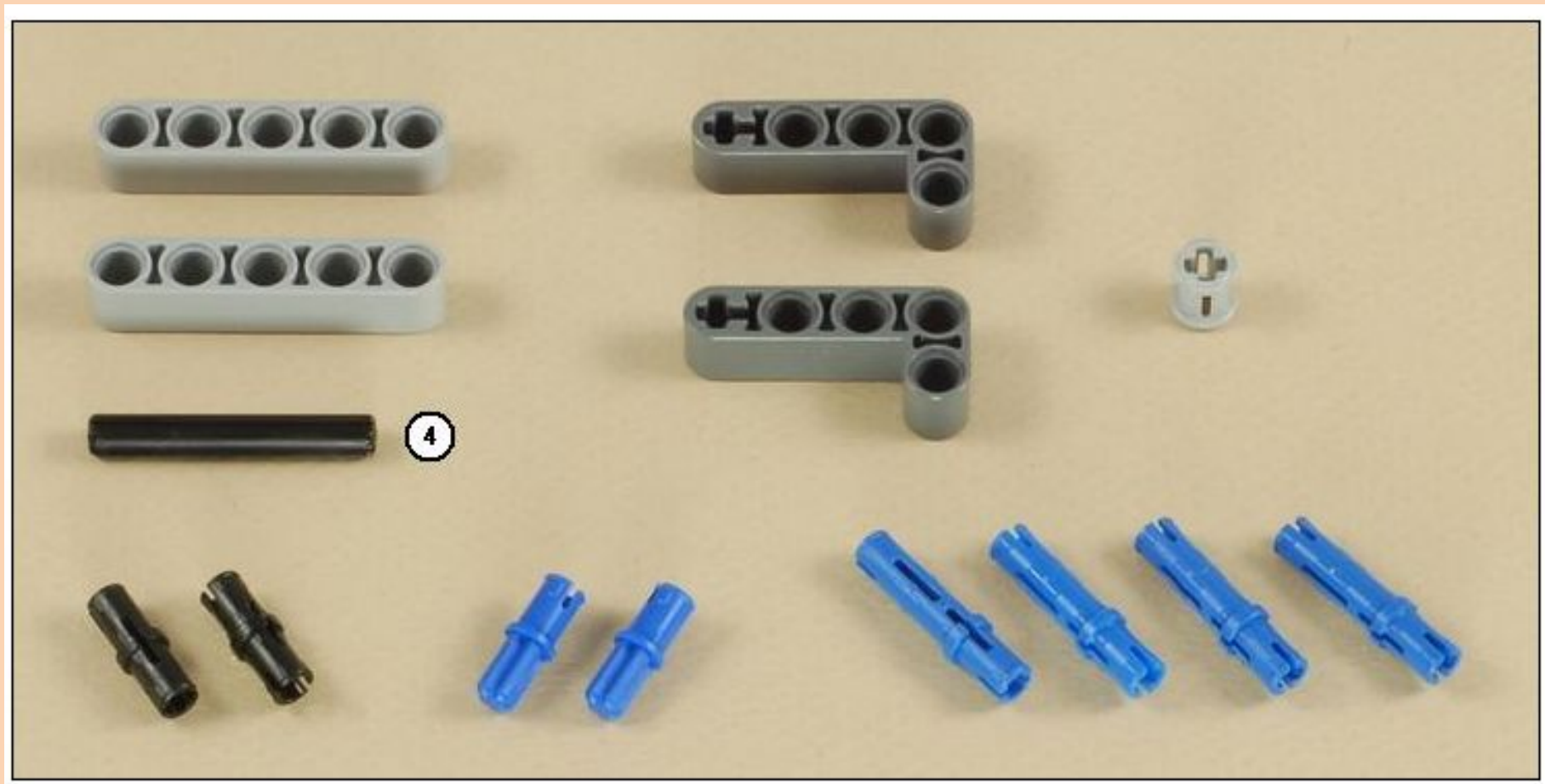

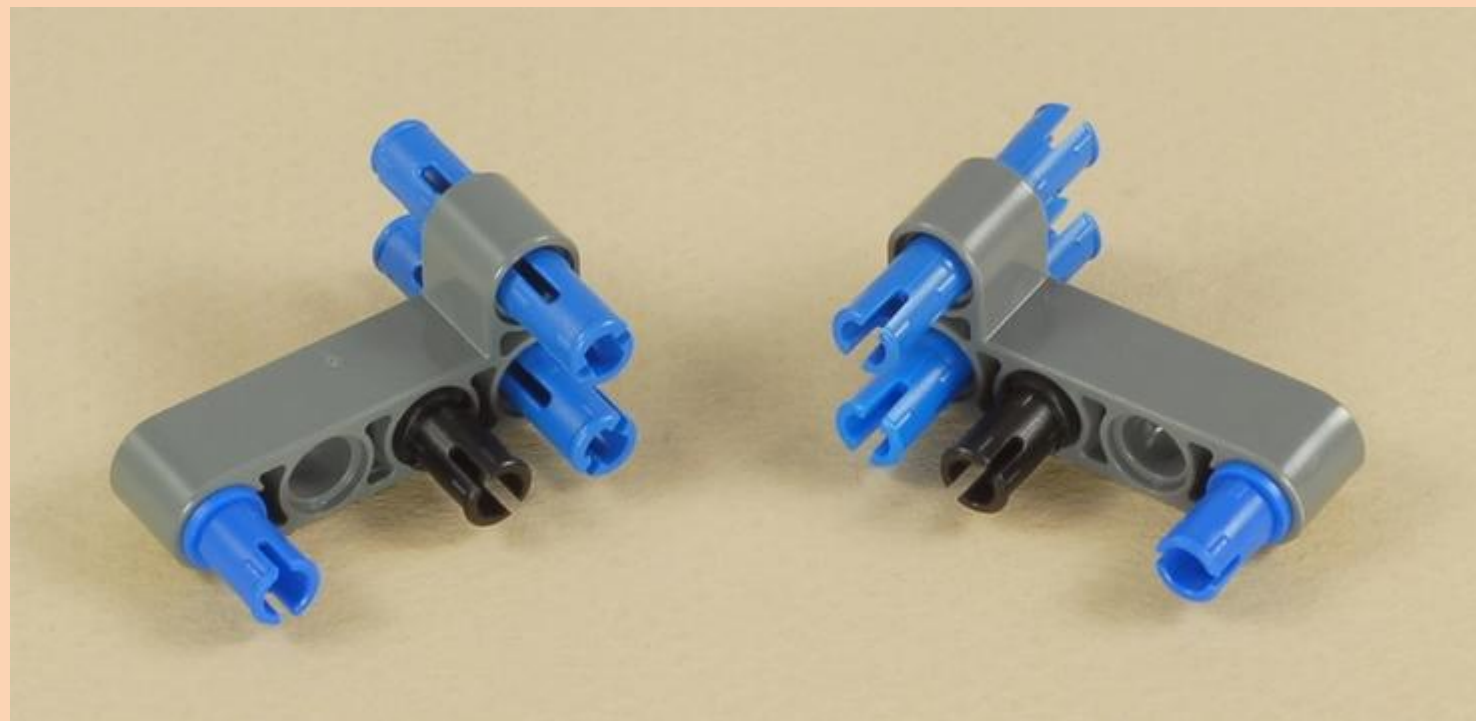

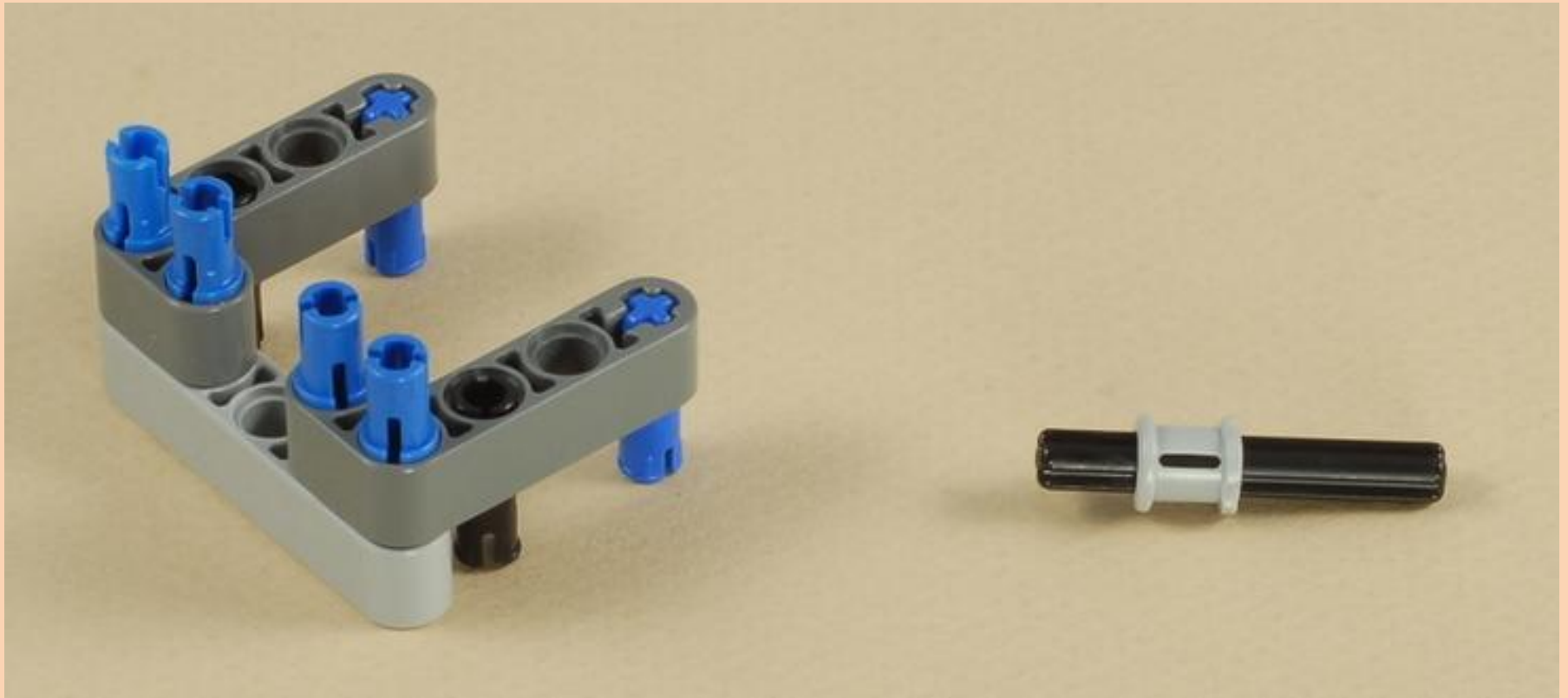

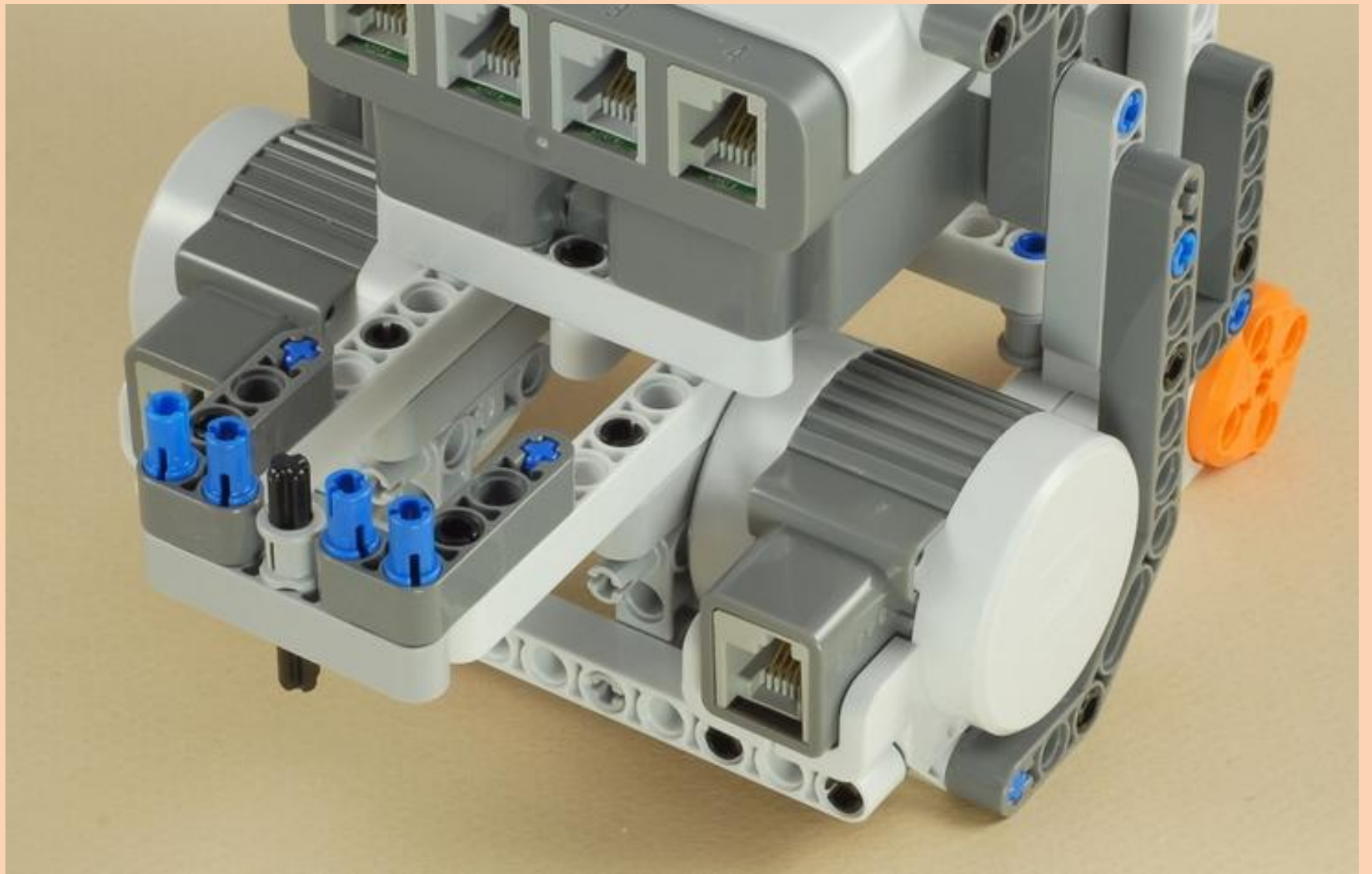

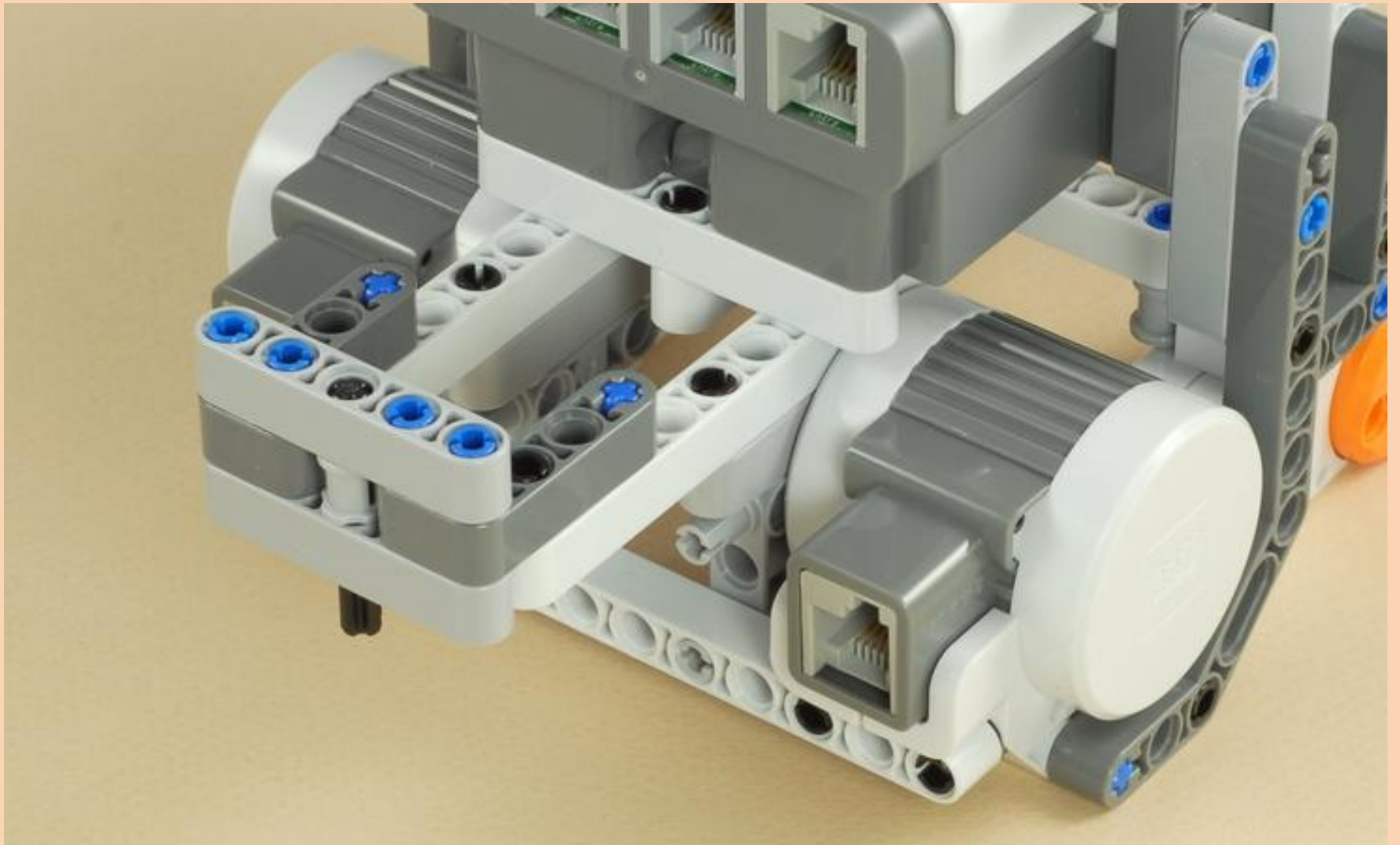



6

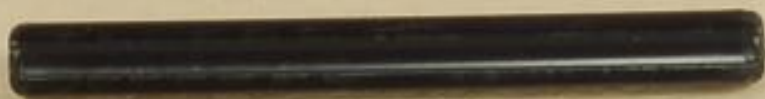

6





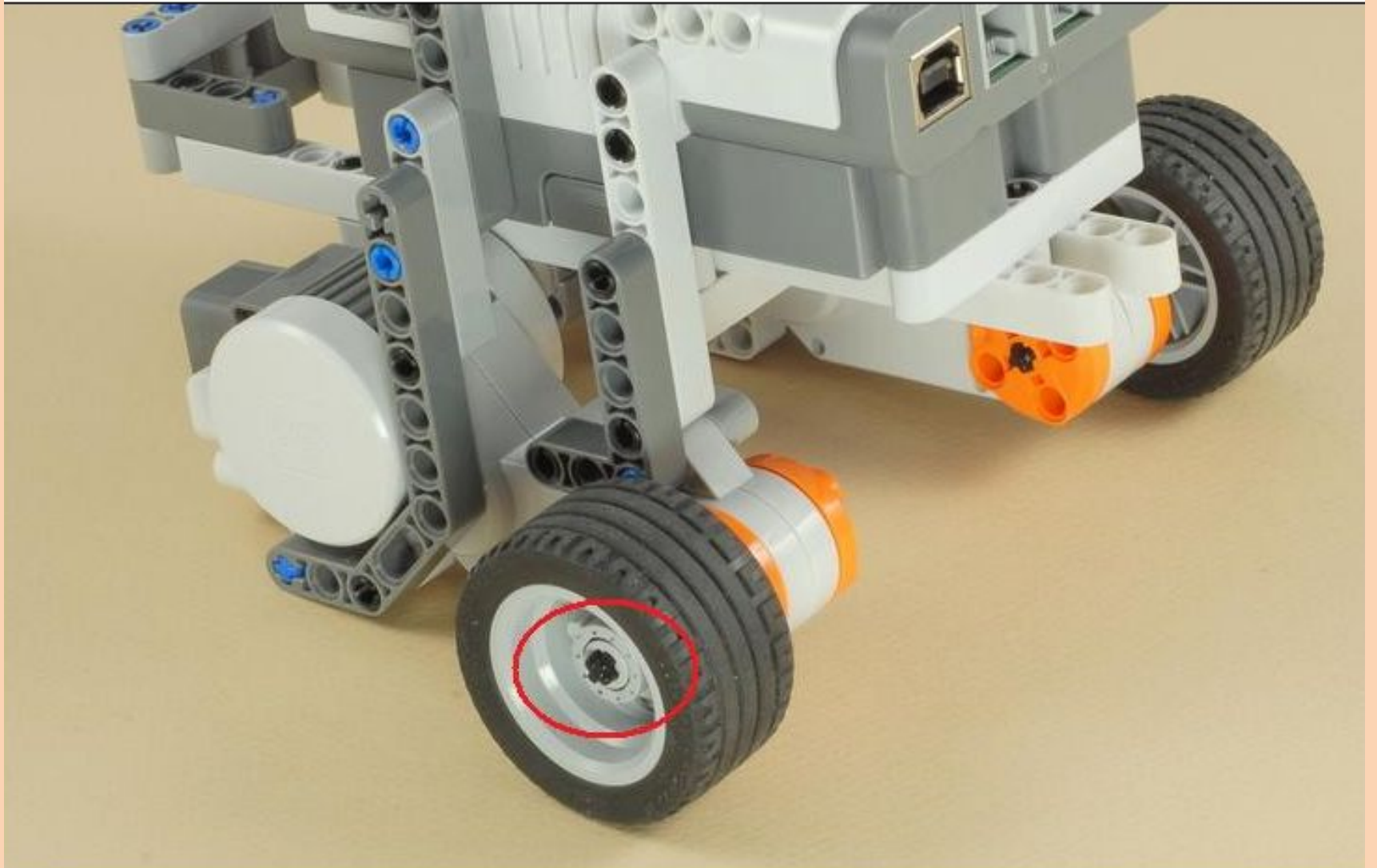

5

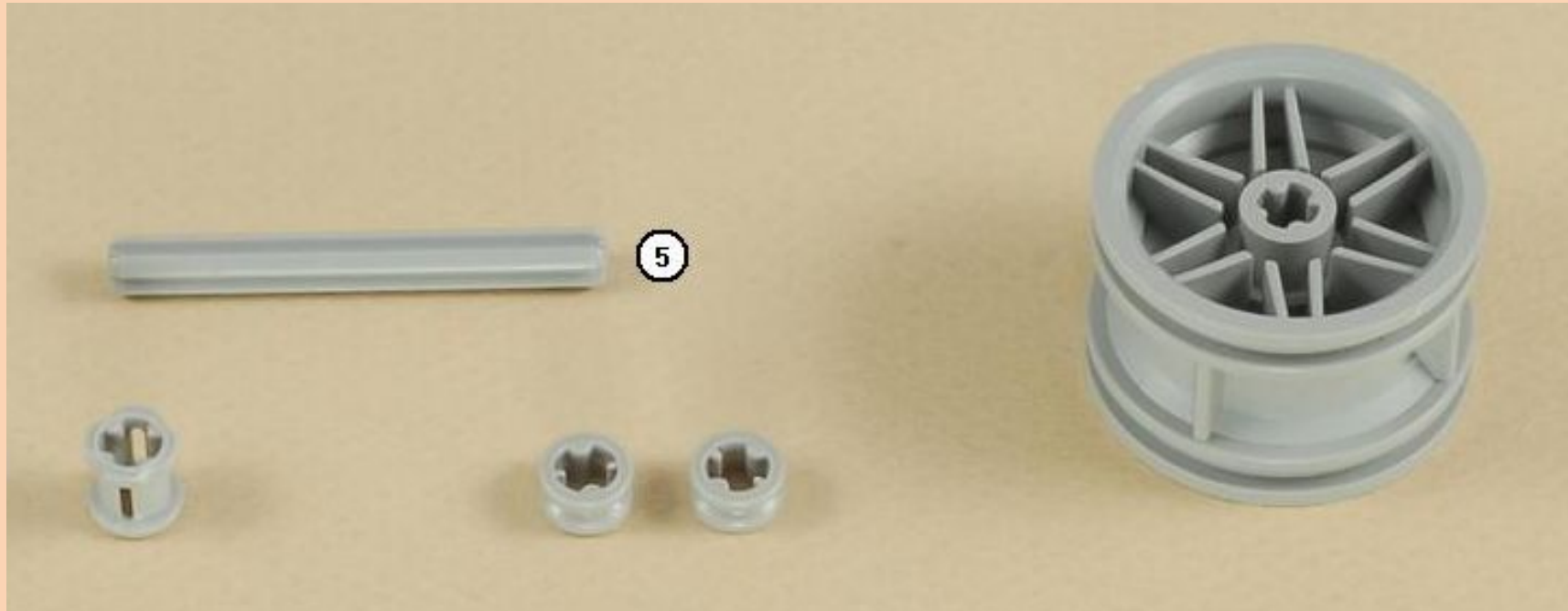







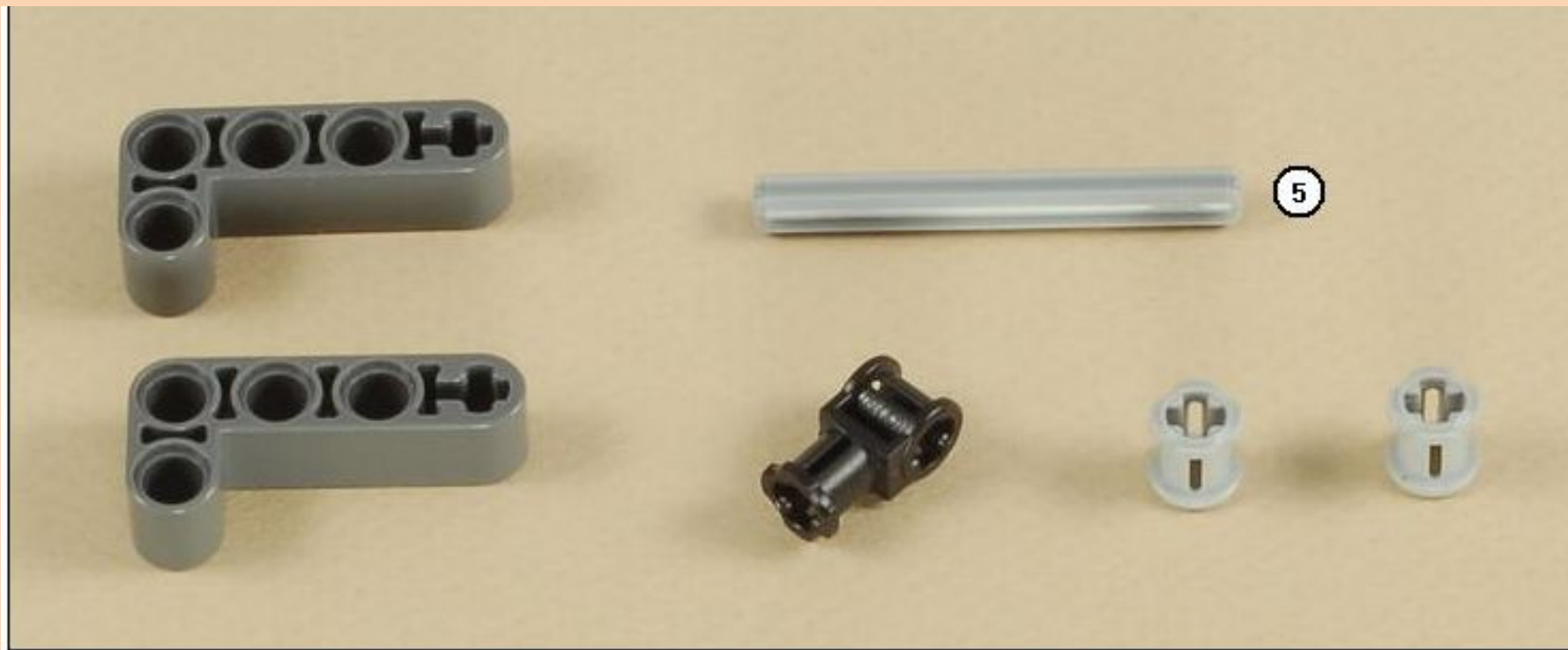





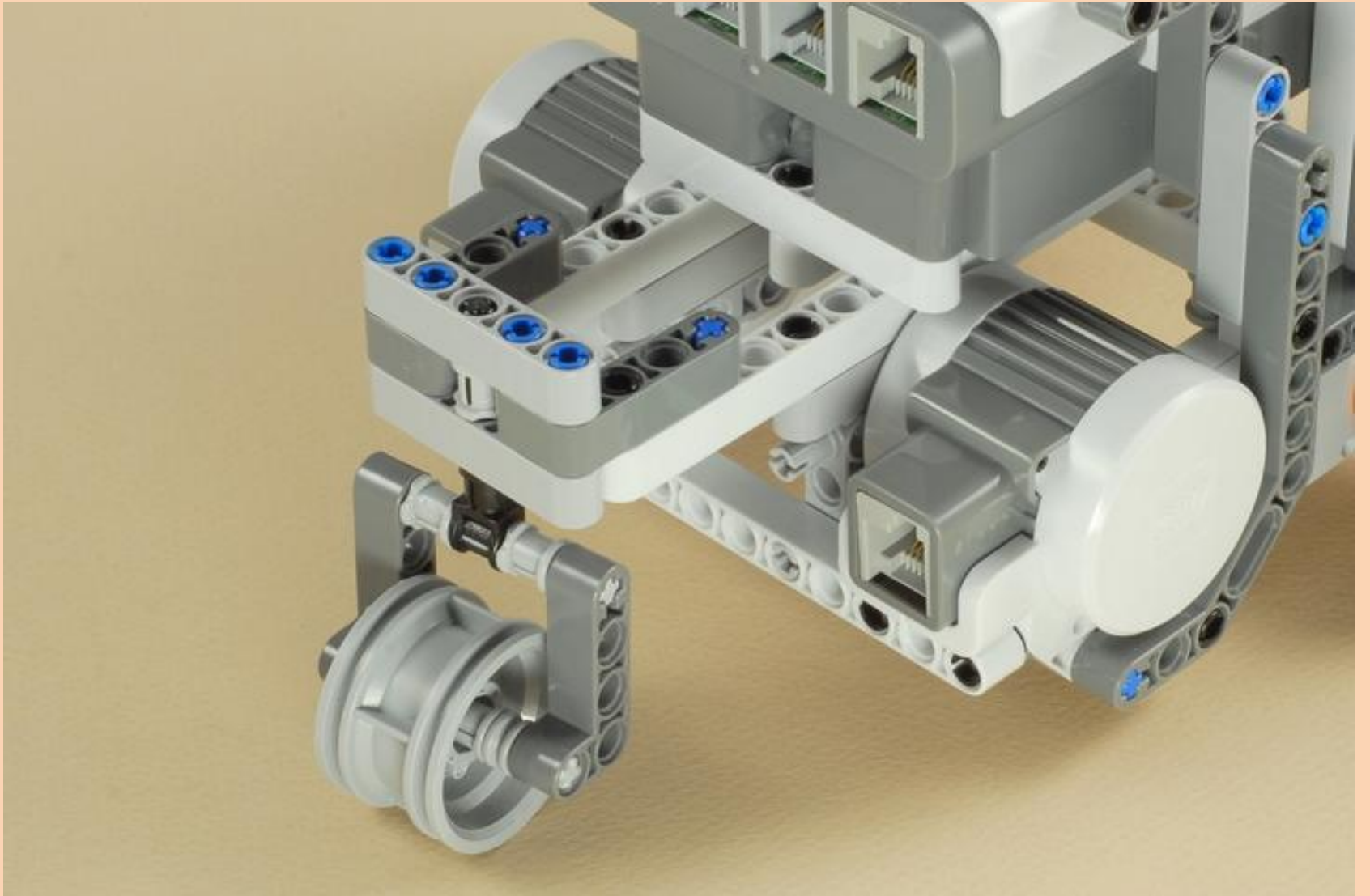



35 cm (Medium) 2 x



Бот - внедорожник

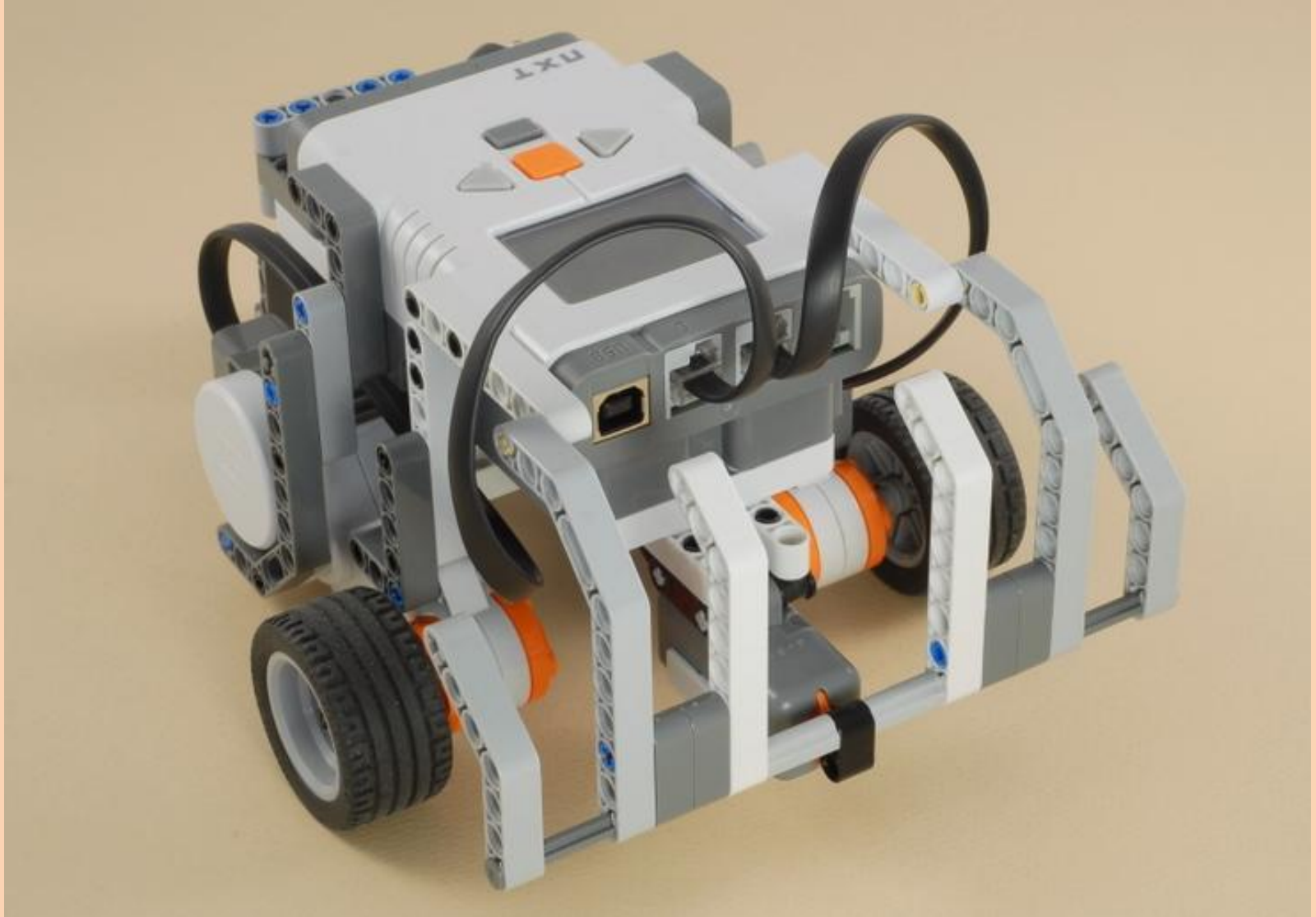







20 cm (Shortest)







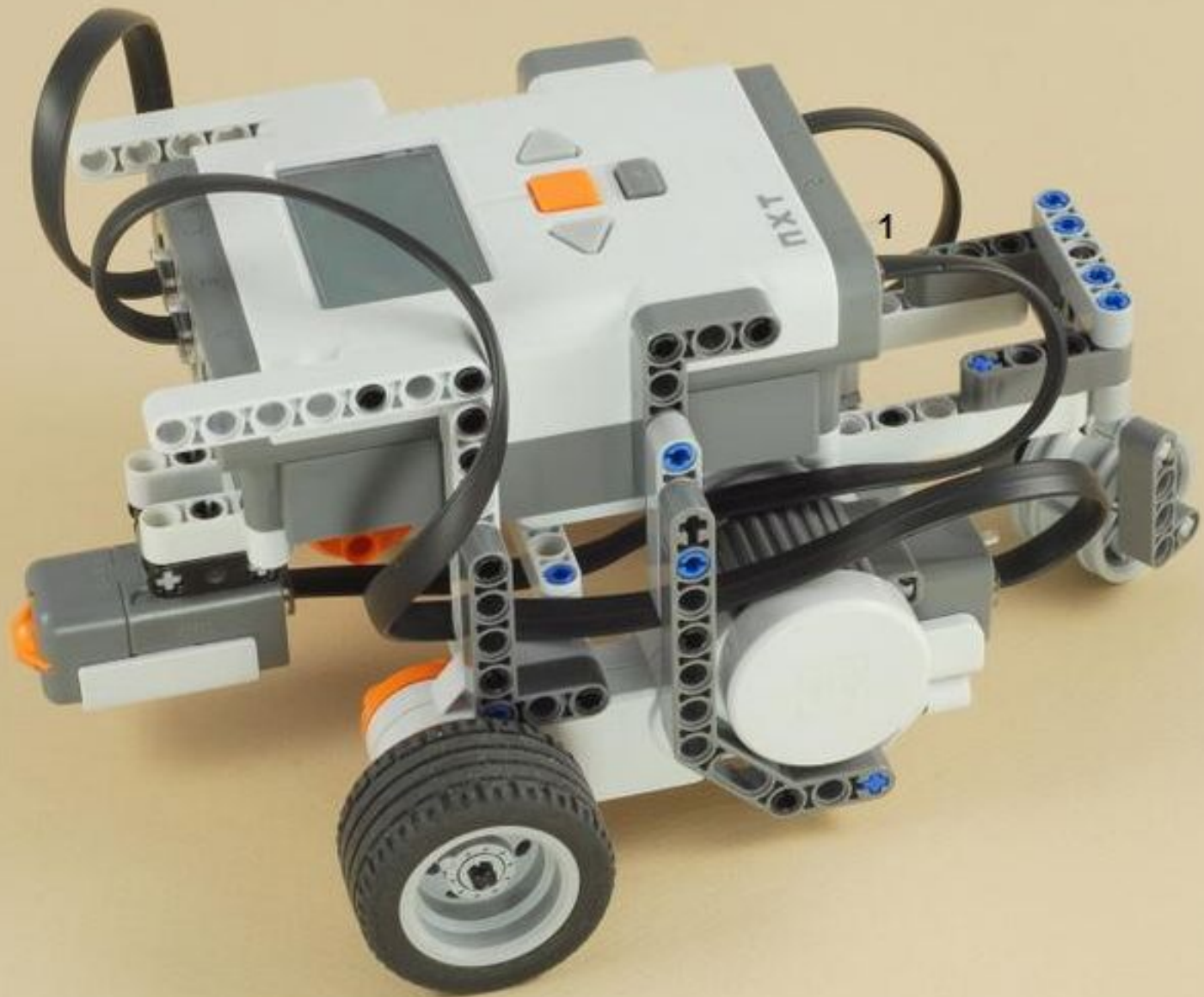

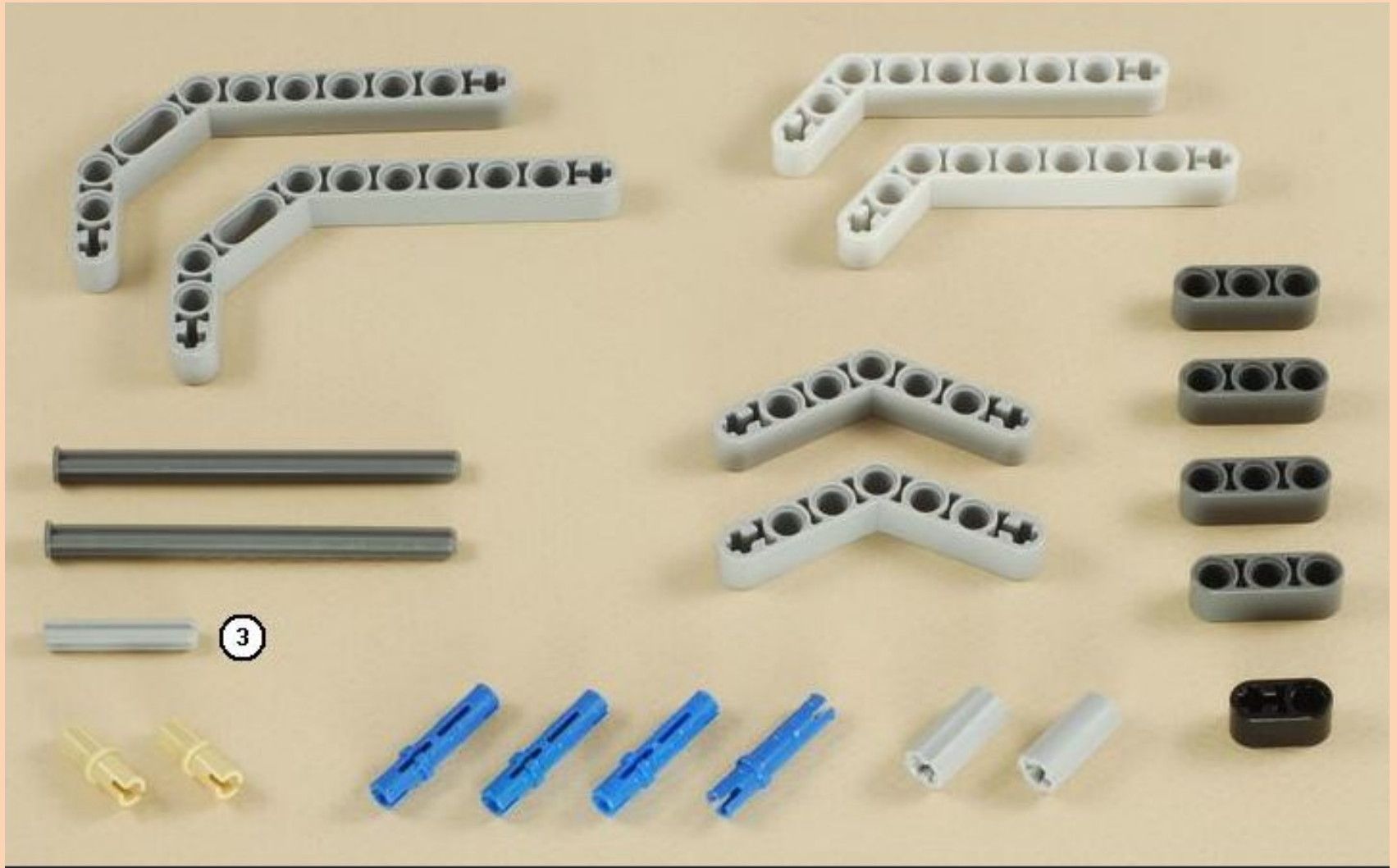



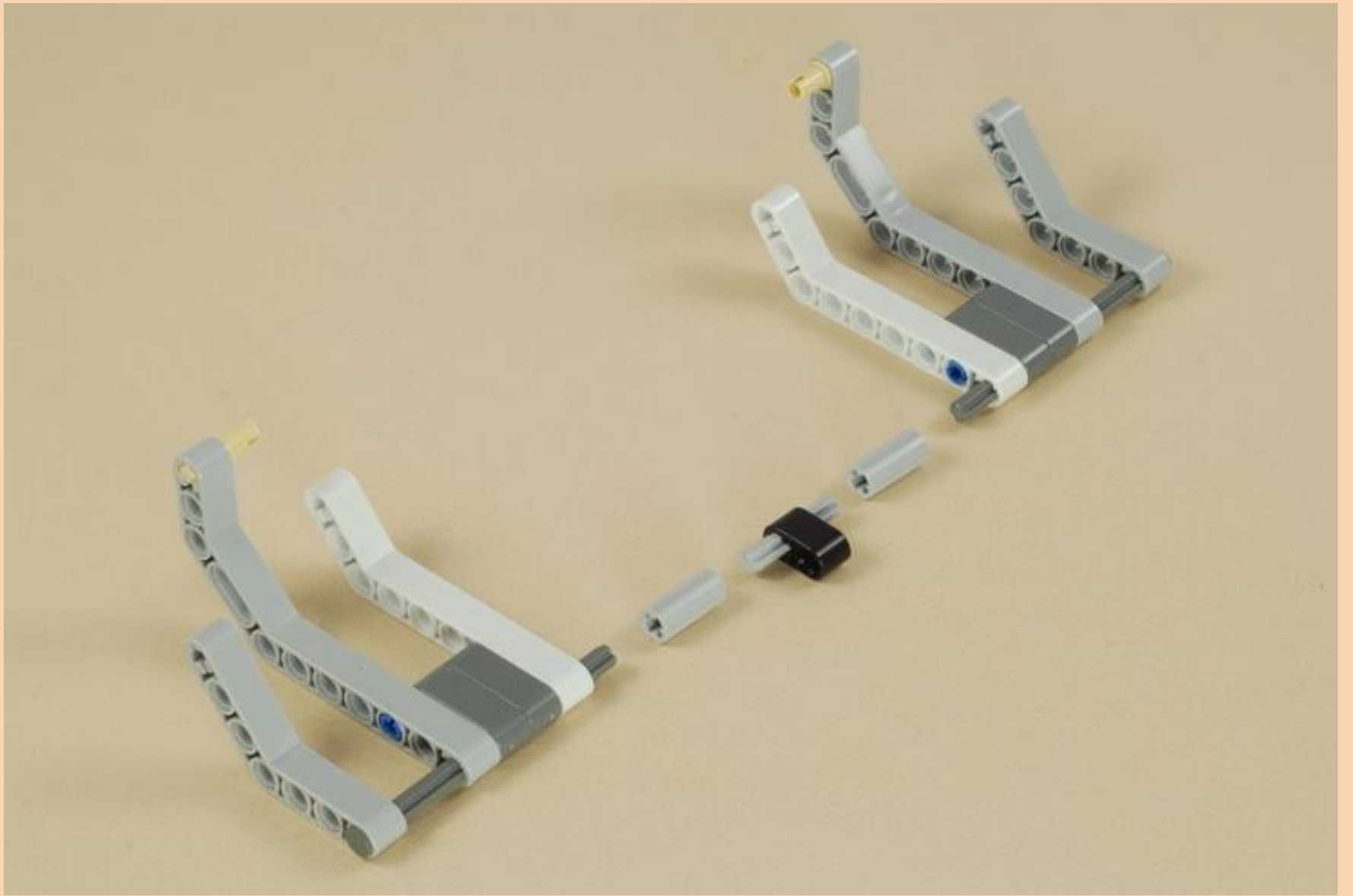

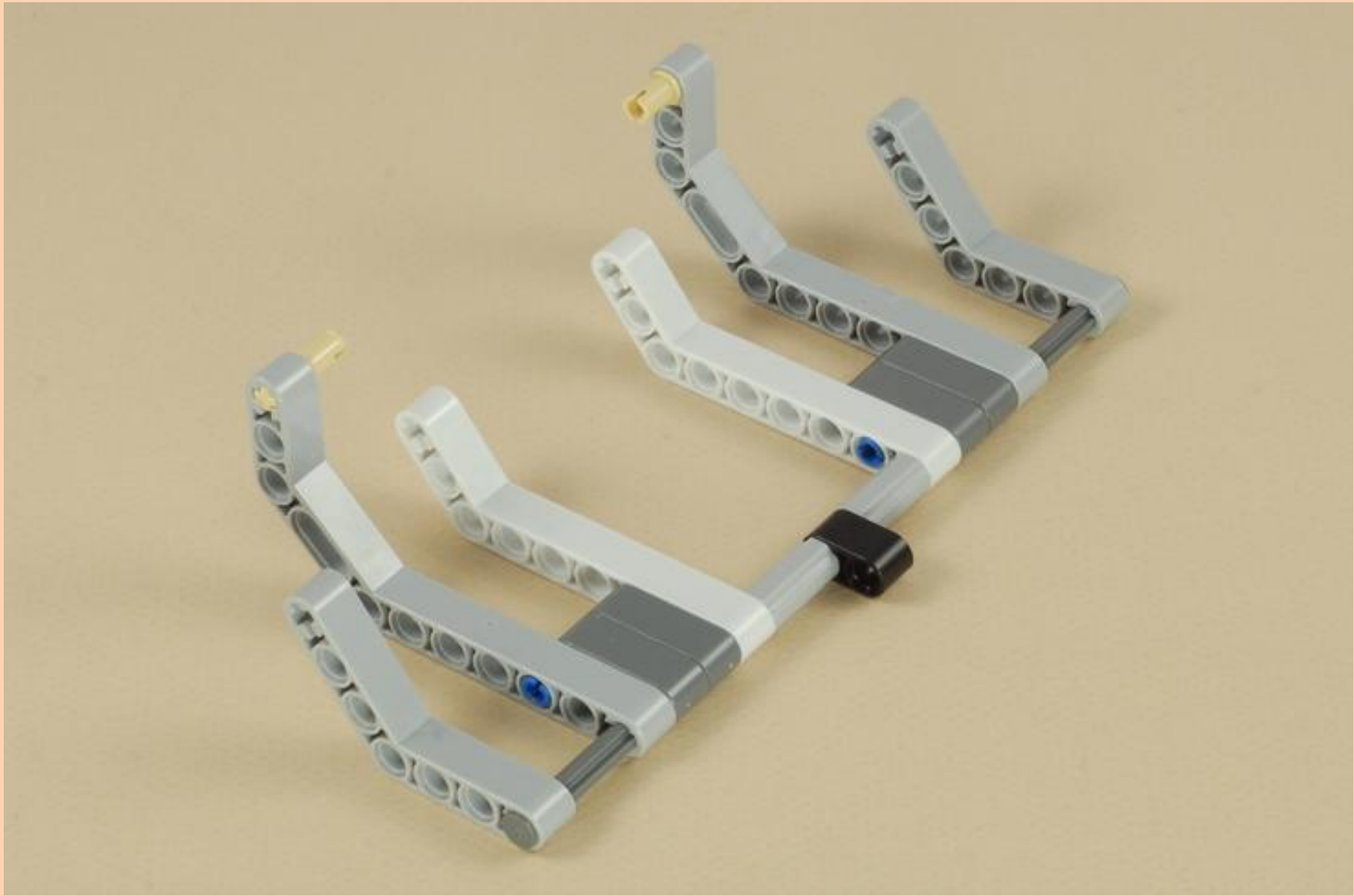

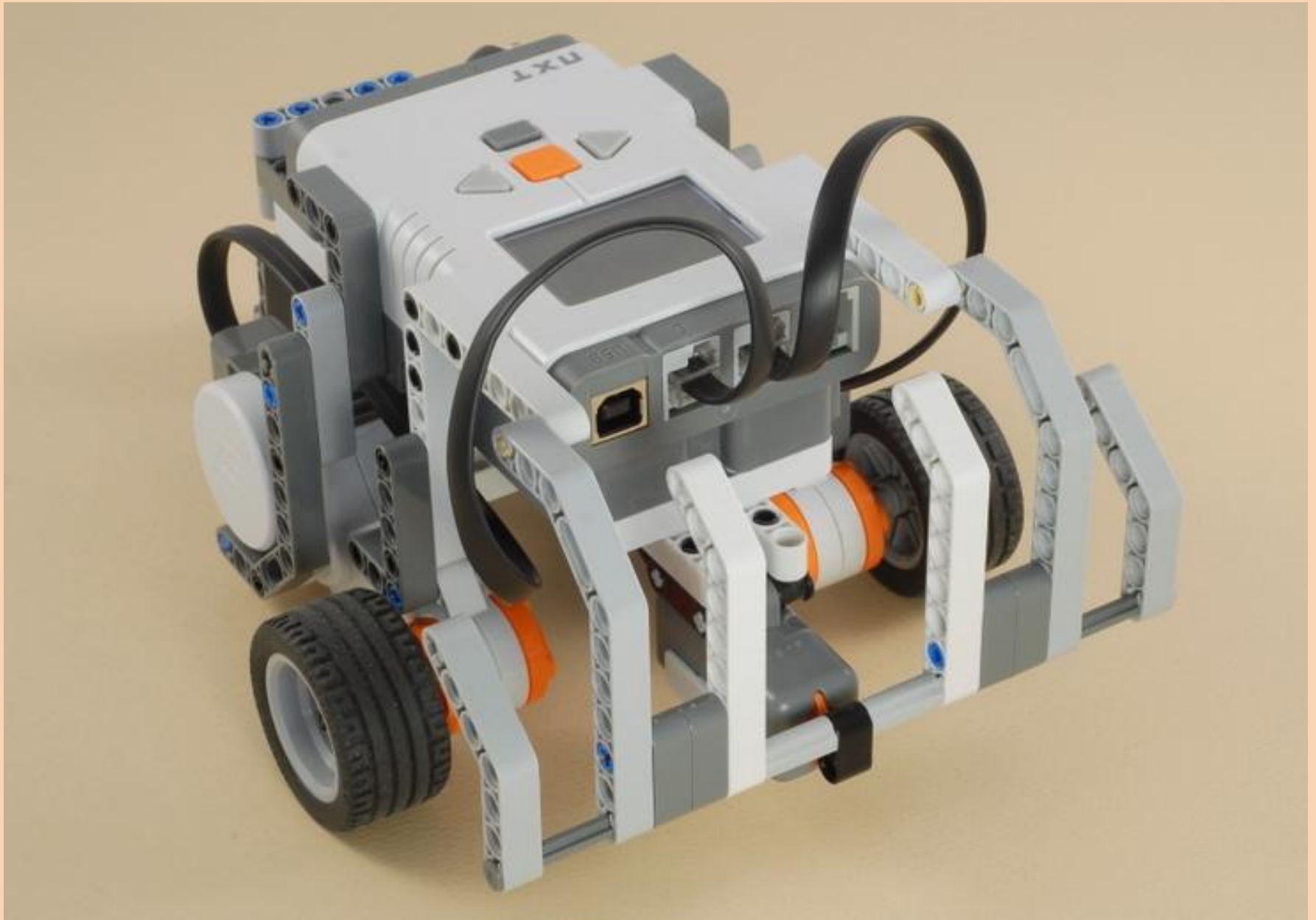

Исследователь





15



13



13





15





3



3





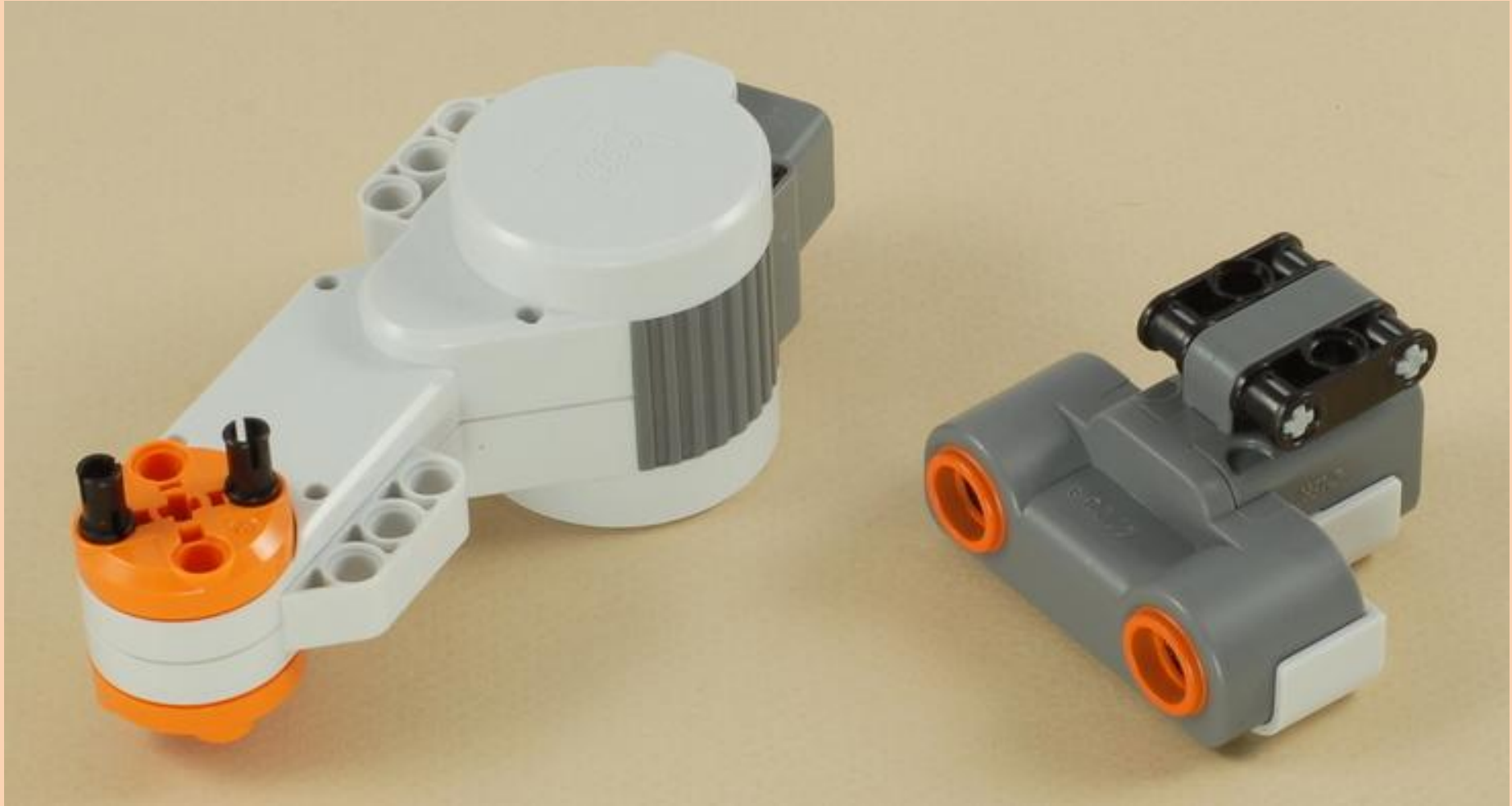

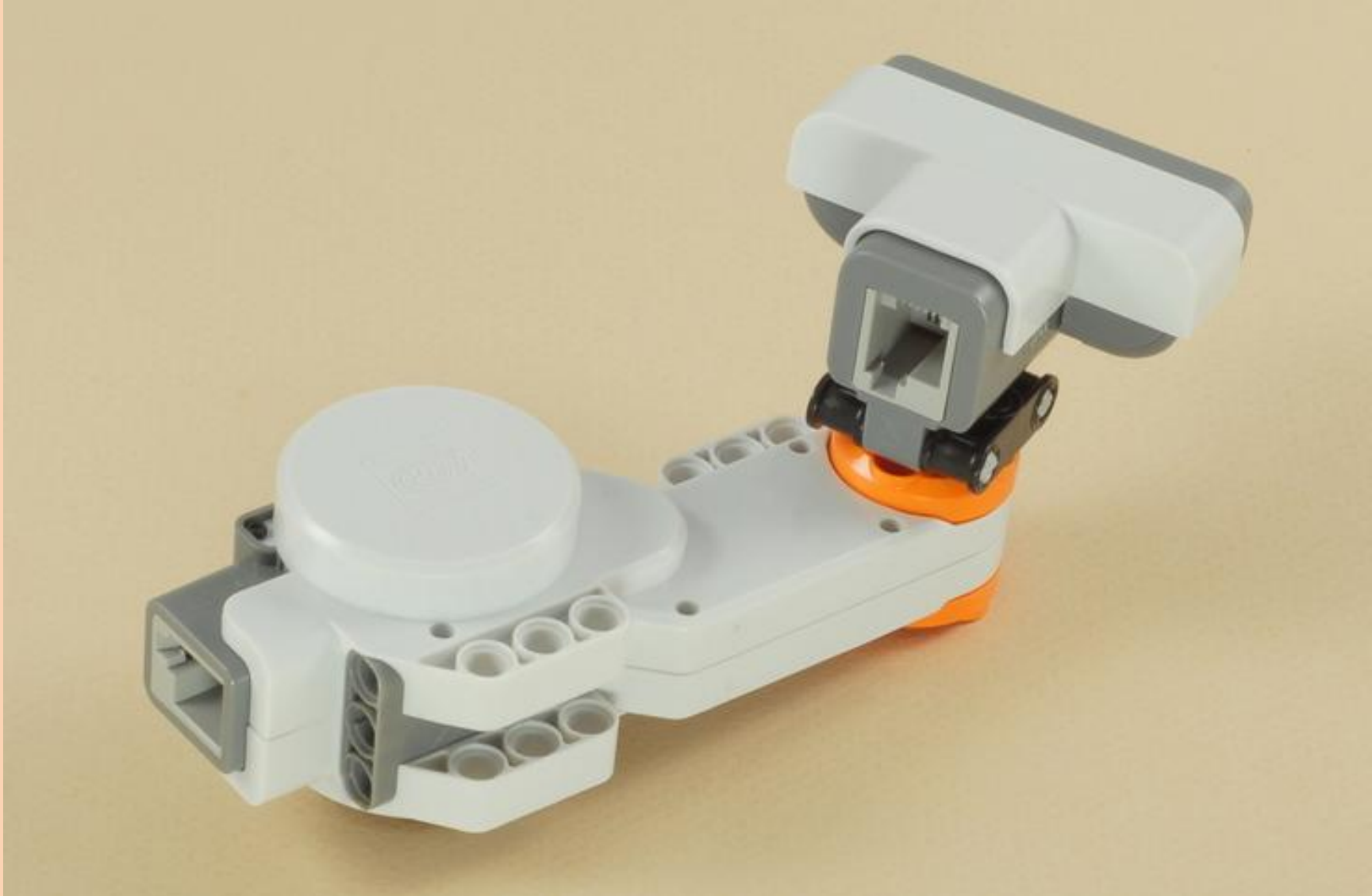

35 cm (Medium) 2 x



