

# Задачи по рисунку. Число 3, 4.

---

Подготовила: учитель начальных классов  
Барышникова Анастасия Александровна

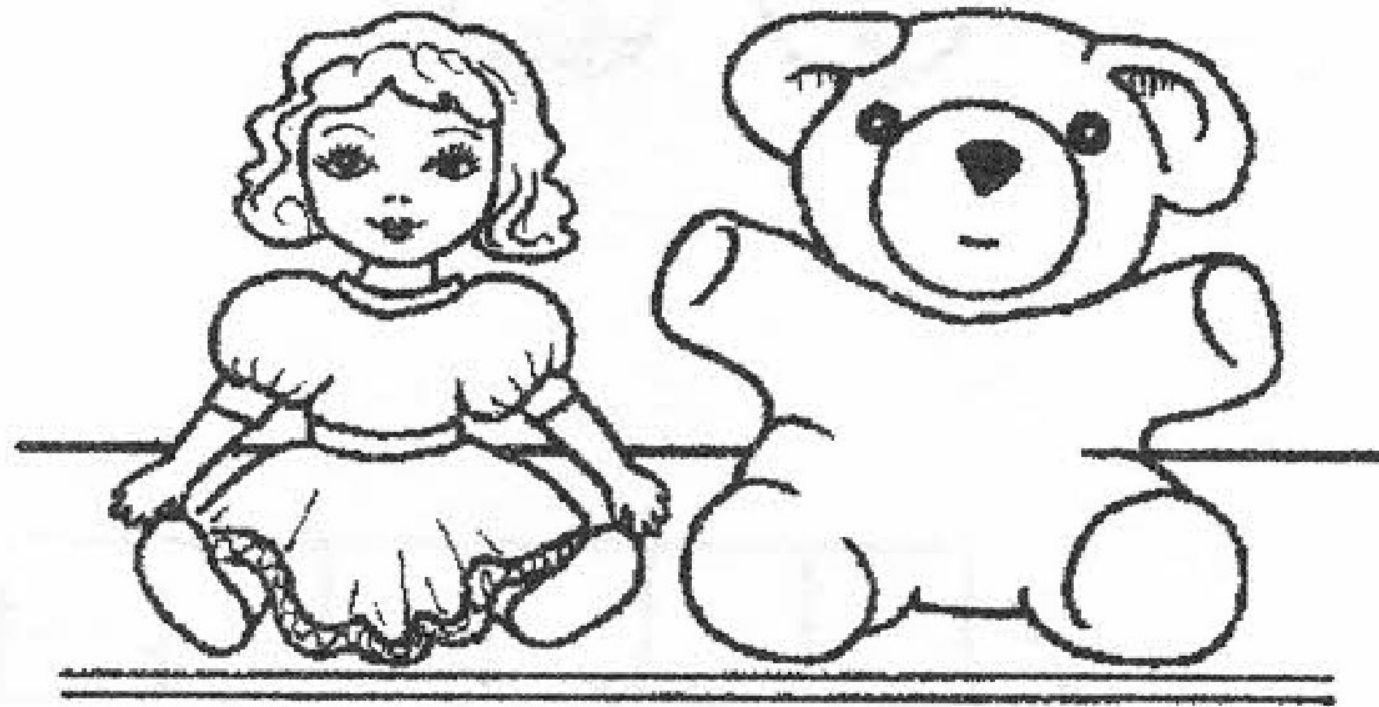

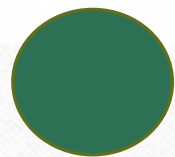
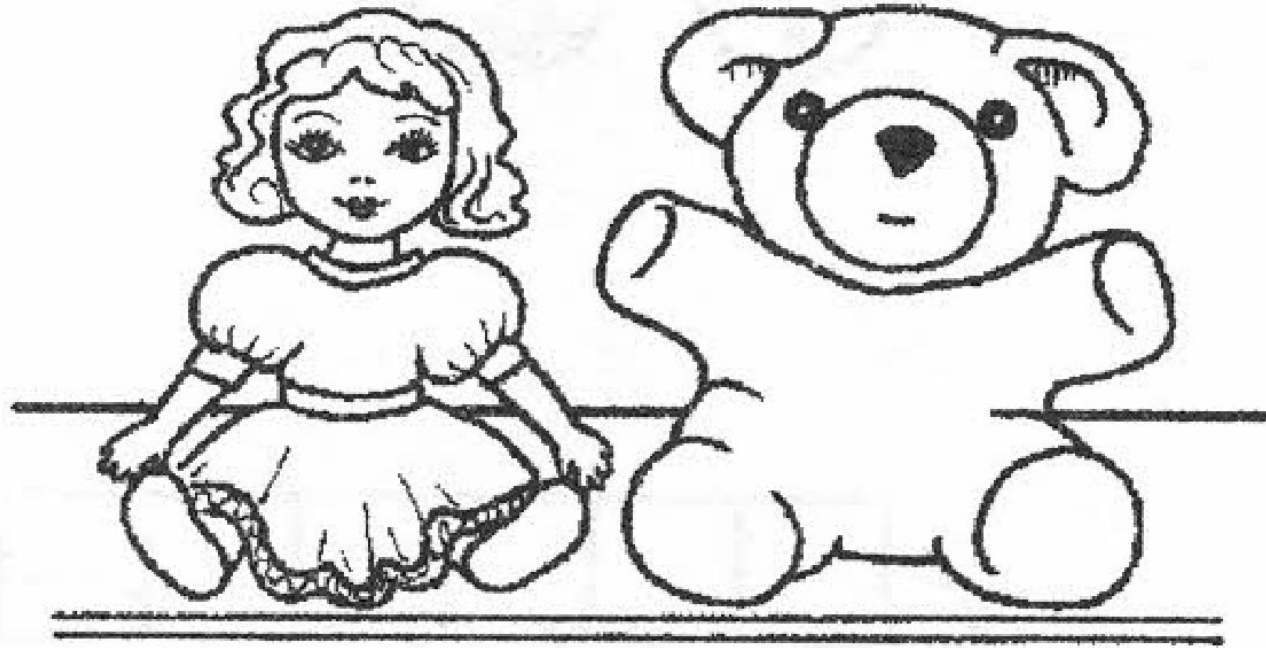

$$1 + 1 =$$

2

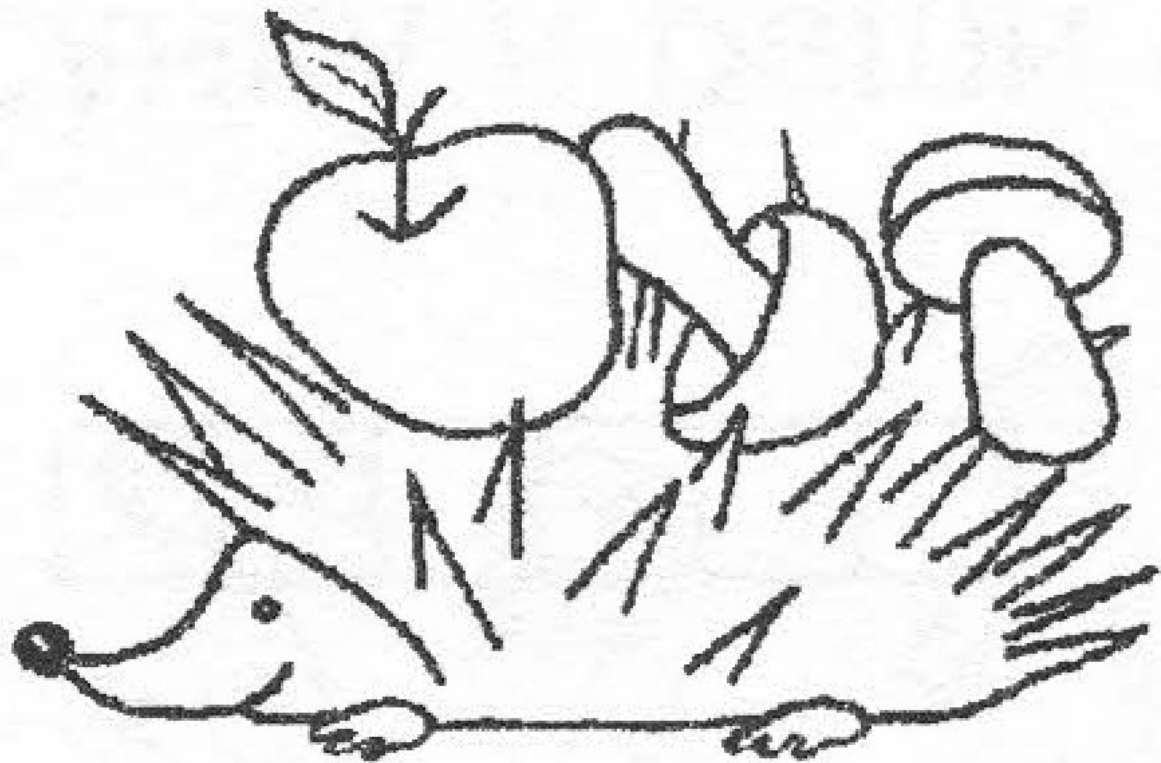

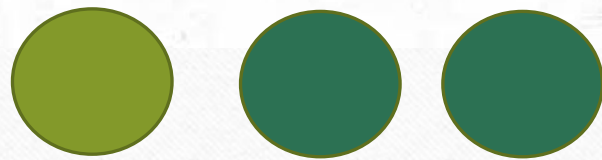
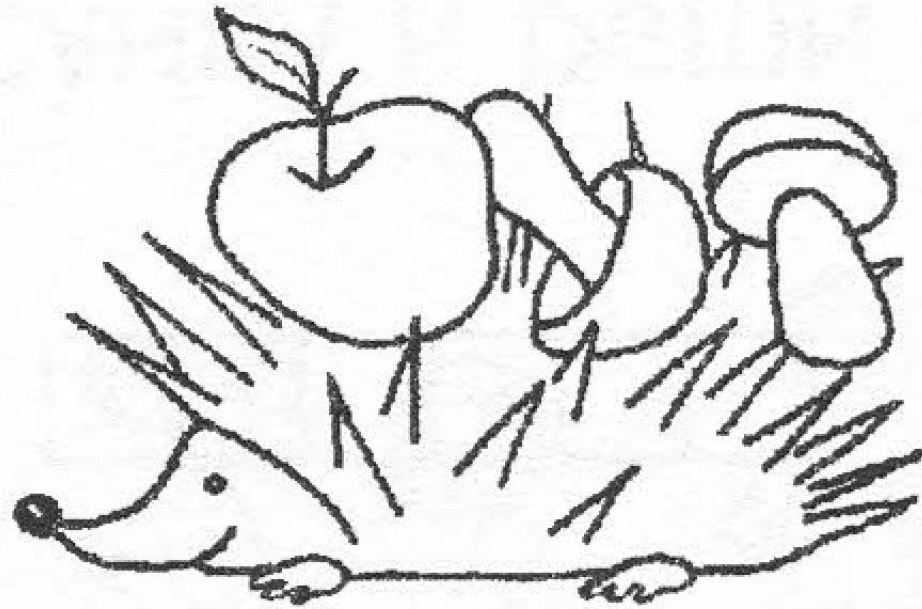

$$1+2=2$$



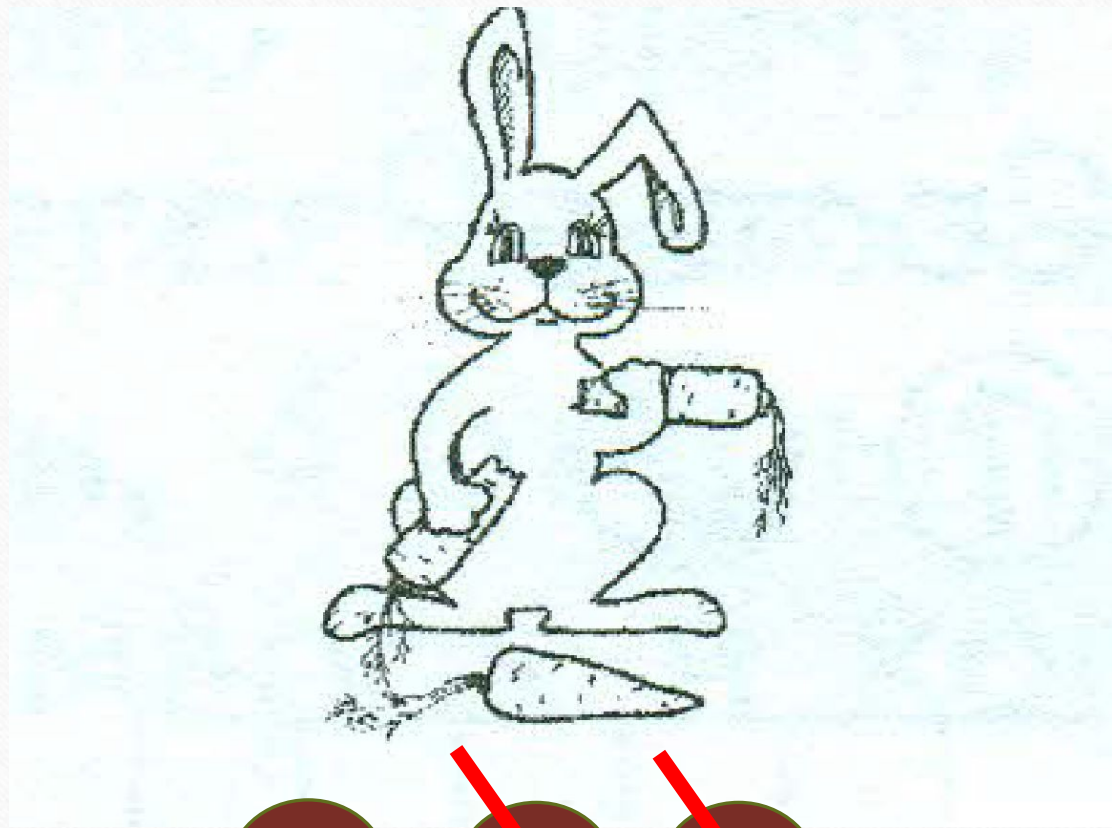

$$3-2=1$$

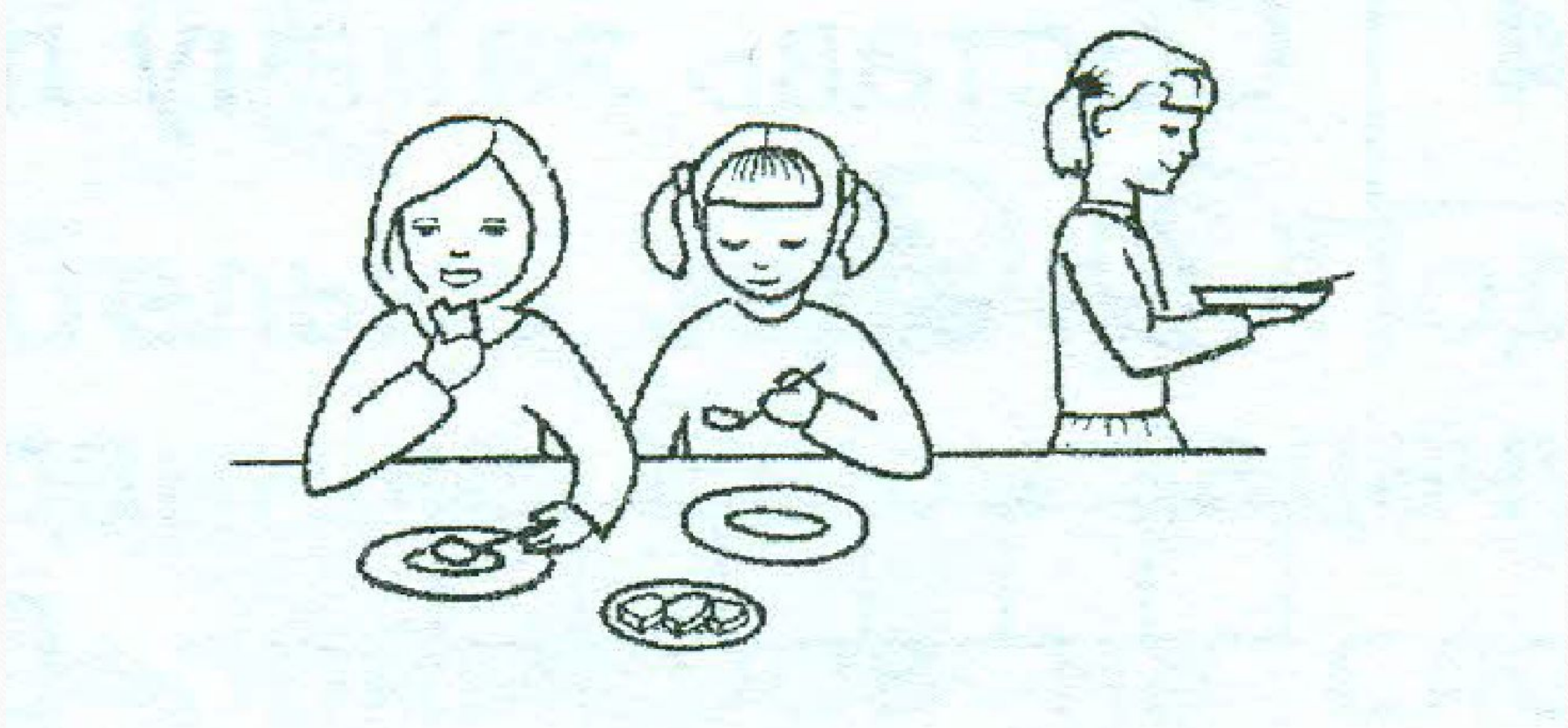



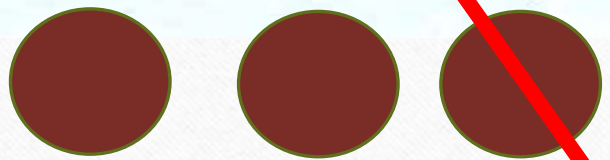

$$3-1=2$$

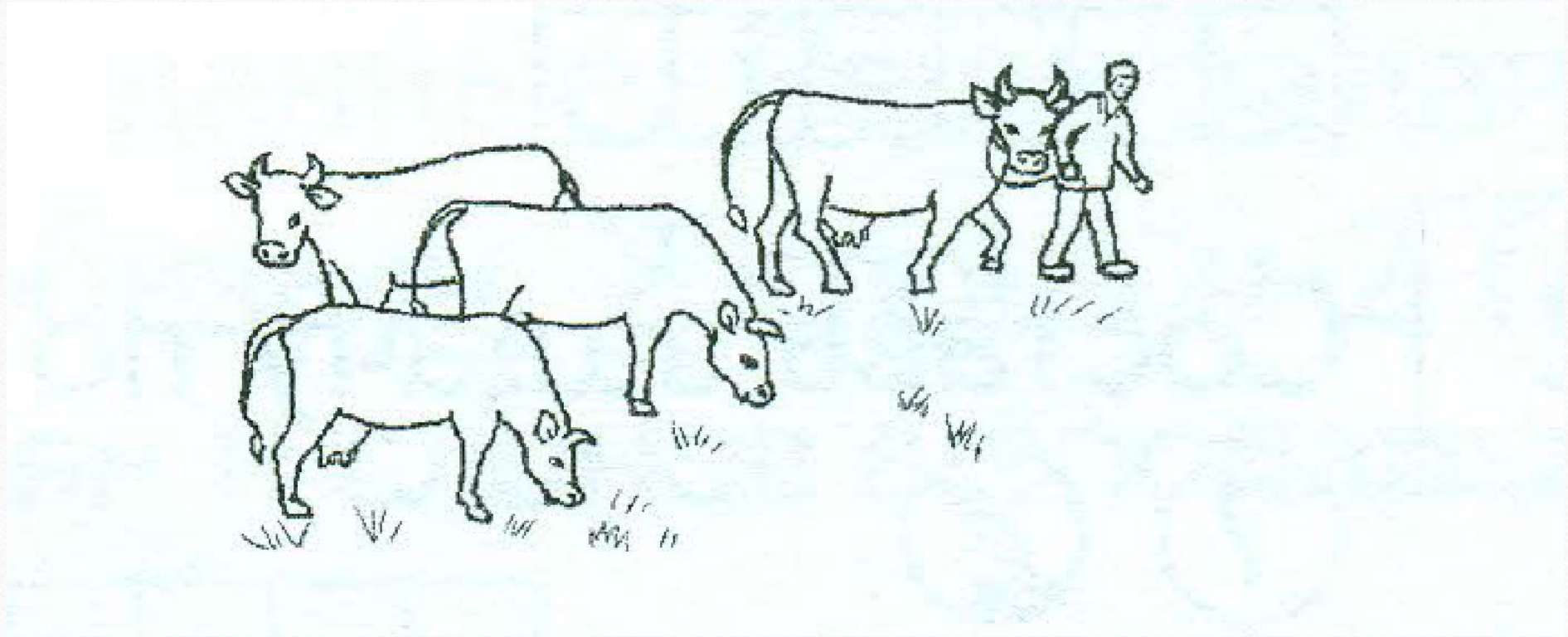

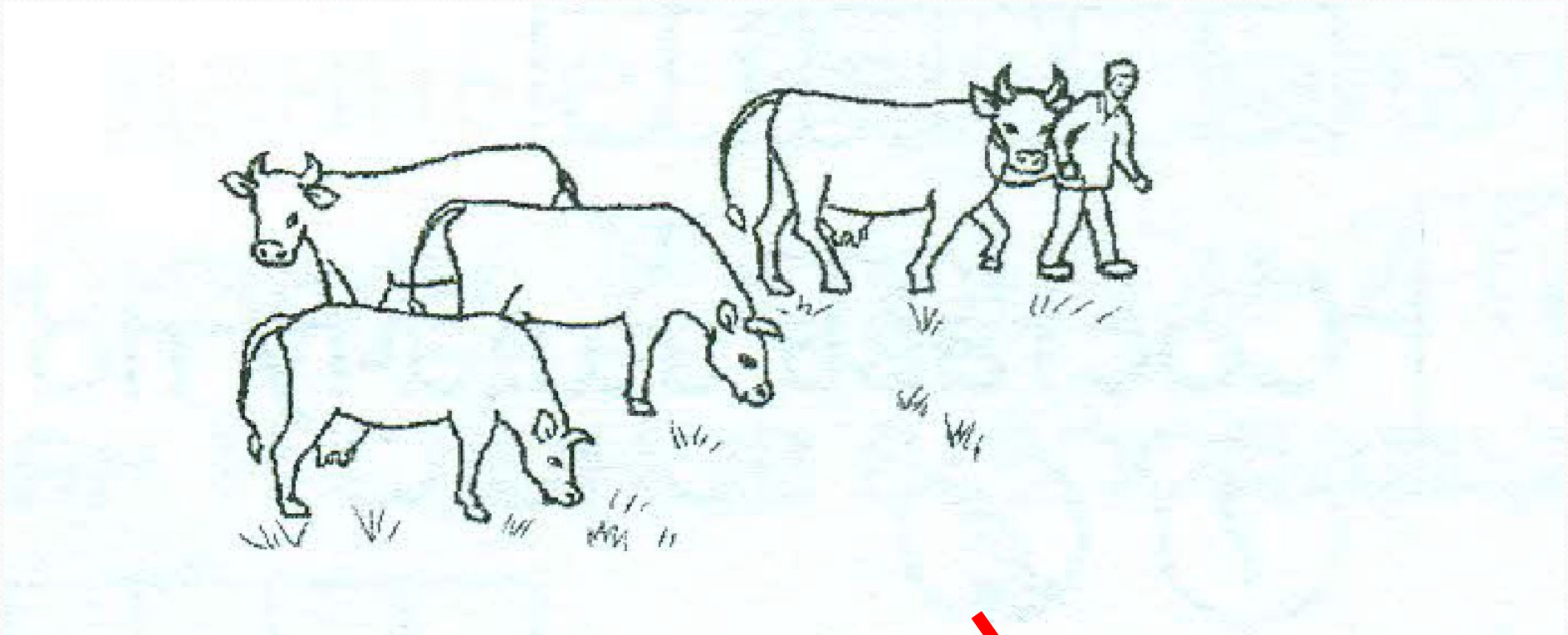

$$4 - 1 = 3$$



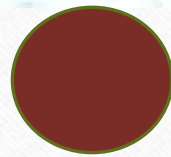
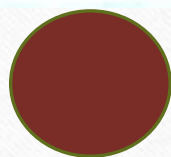
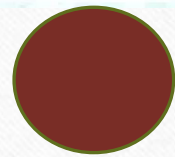

$$4 - 1 = 3$$

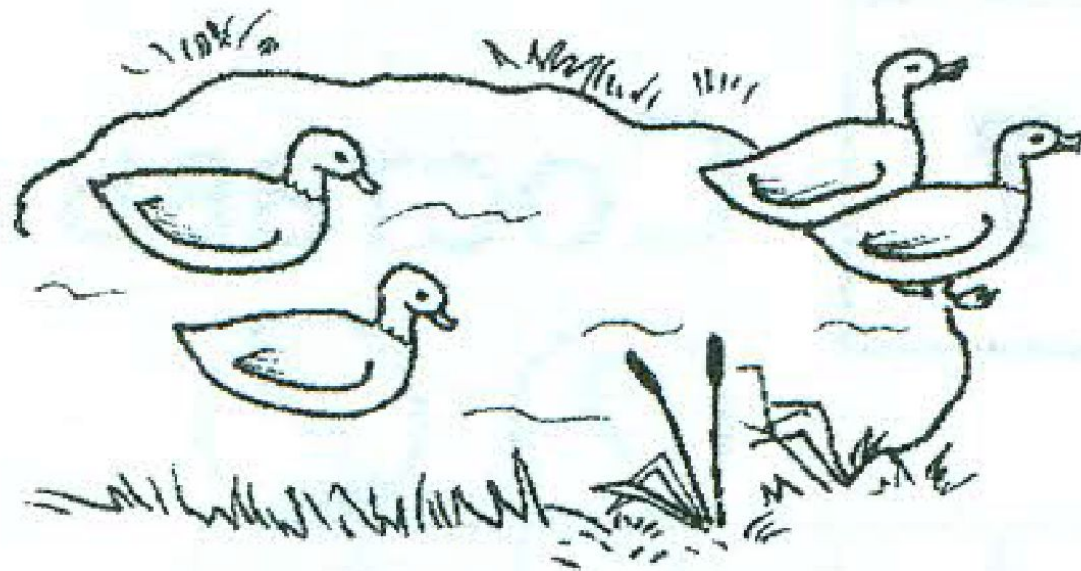

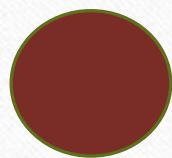
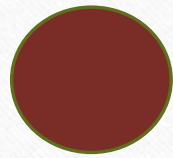
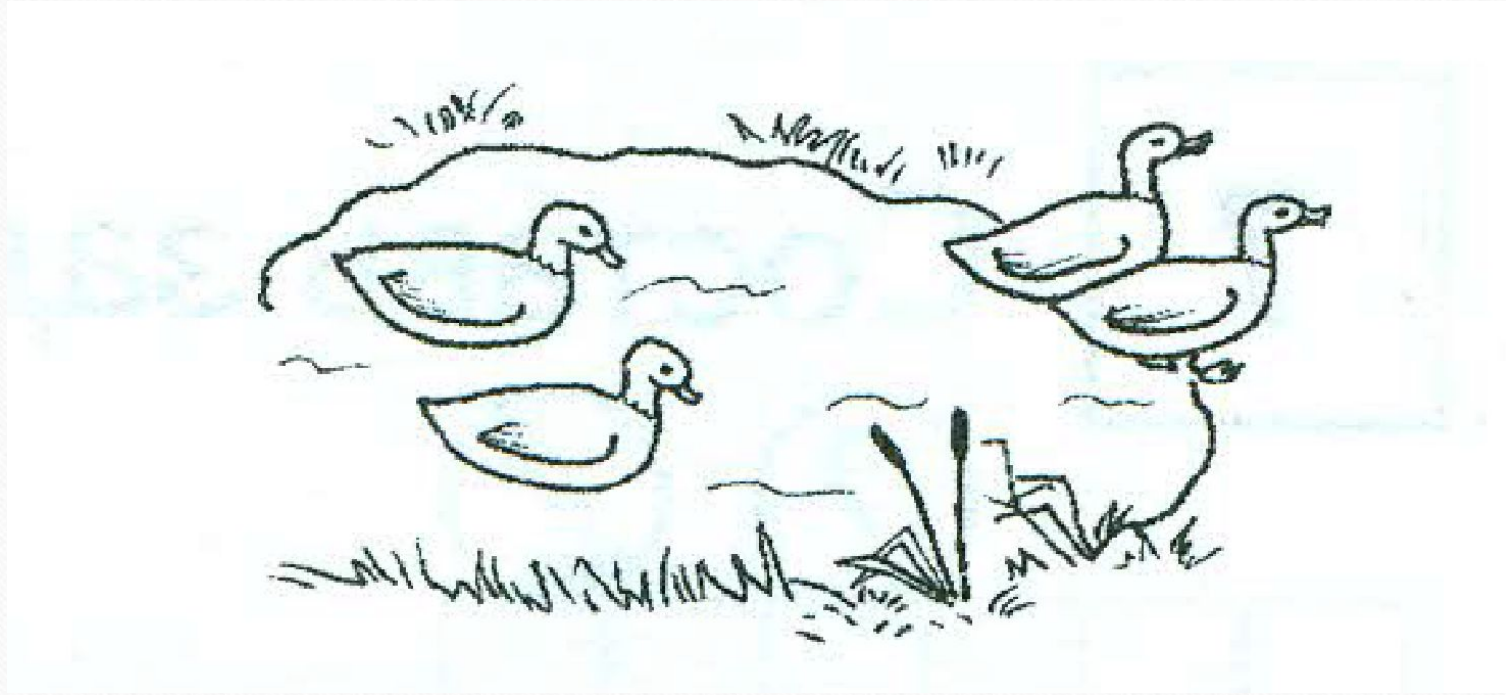

$$4 - 2 = 2$$

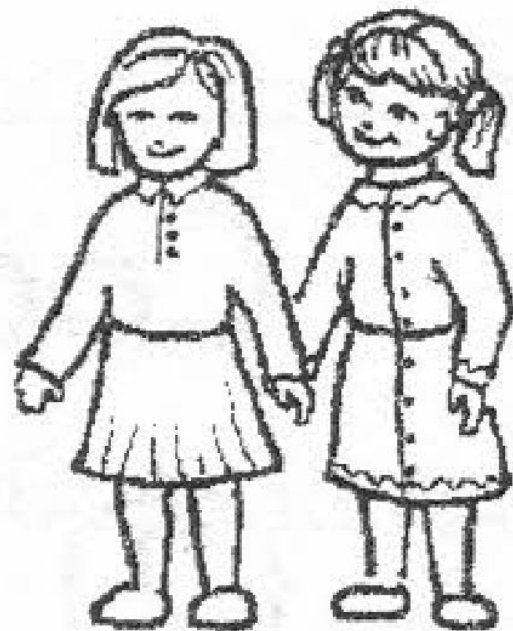



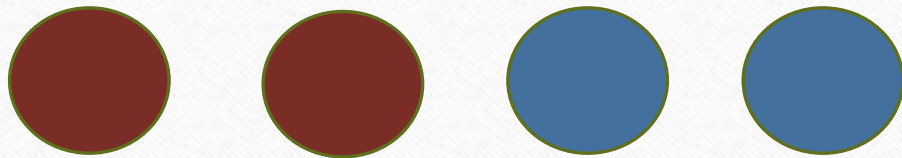

$$2+2=4$$

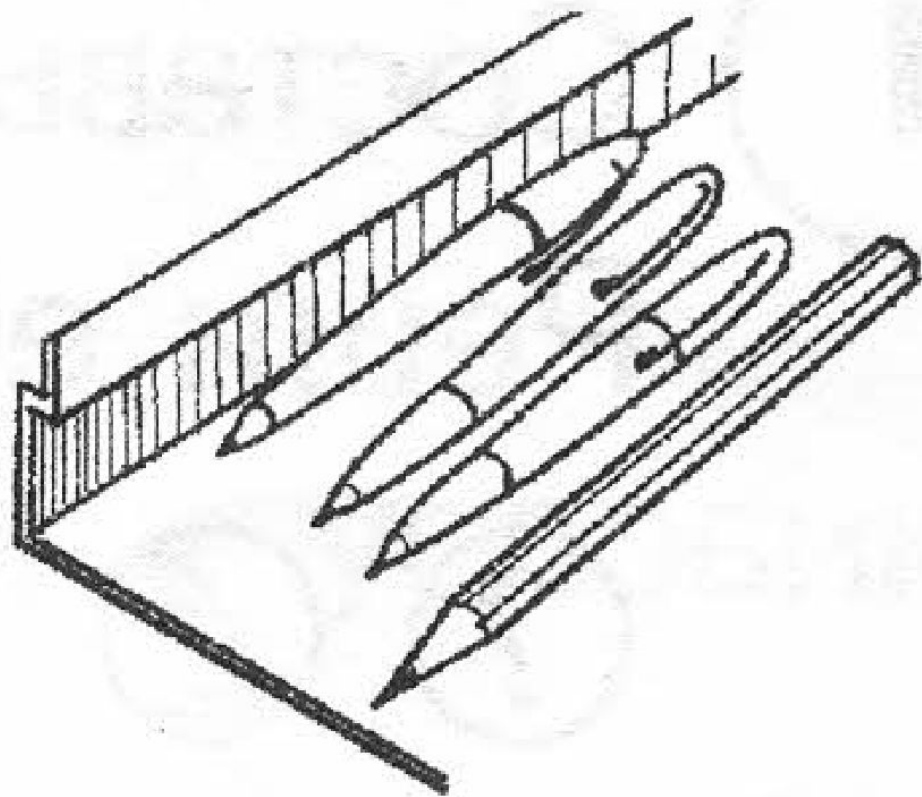

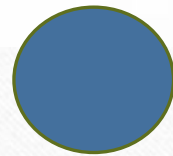
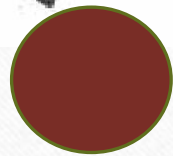
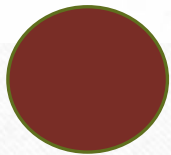
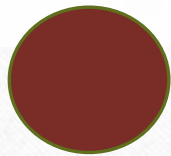
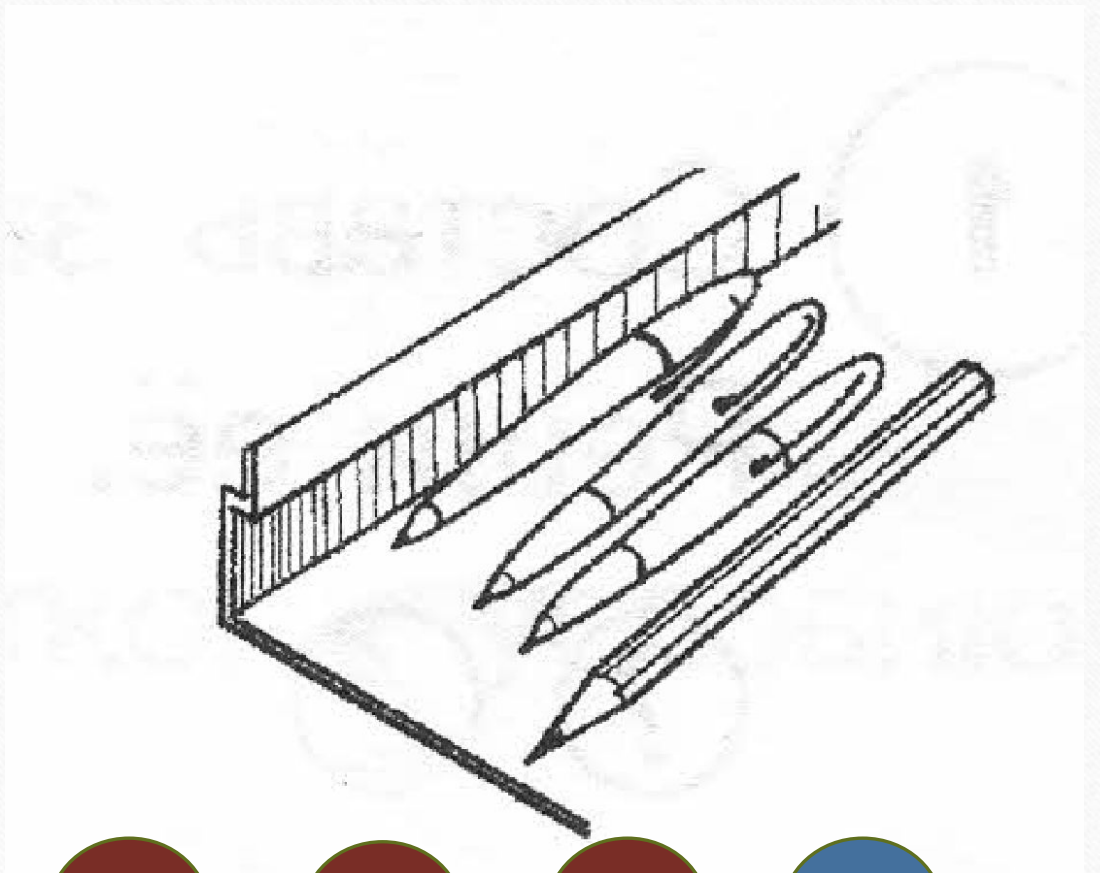

$$3+1=4$$

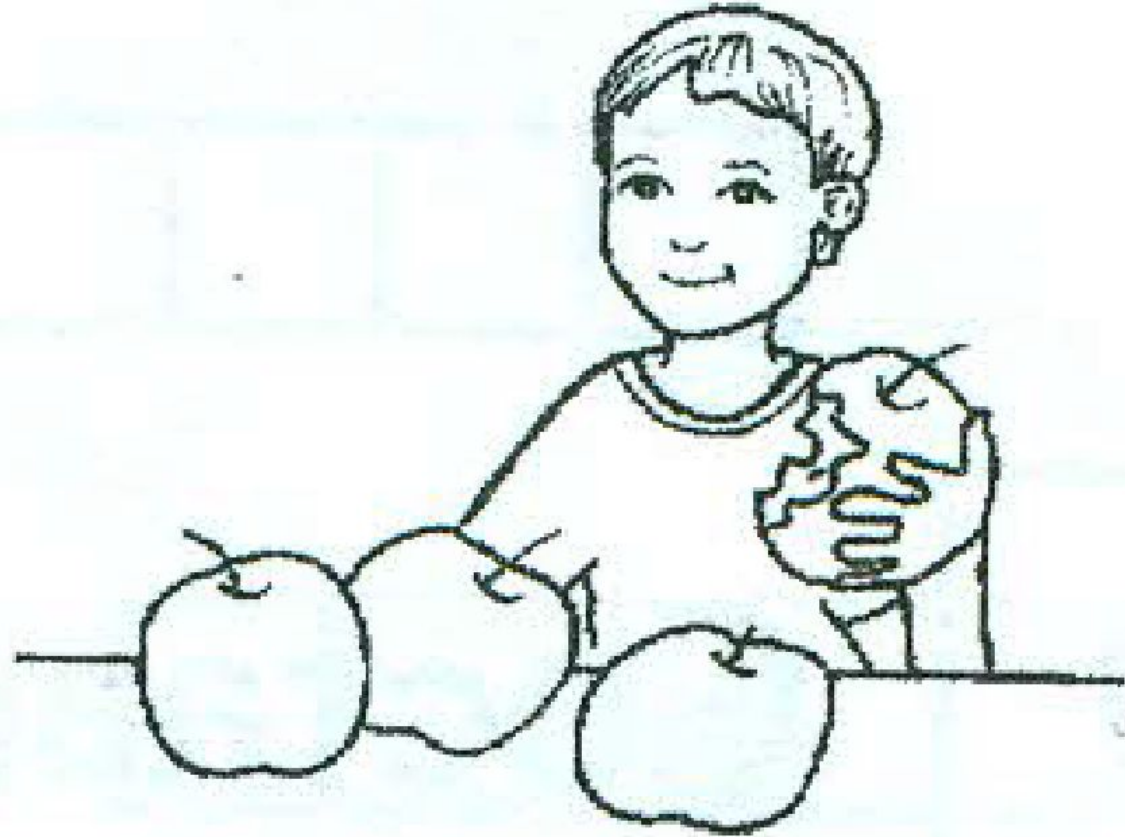

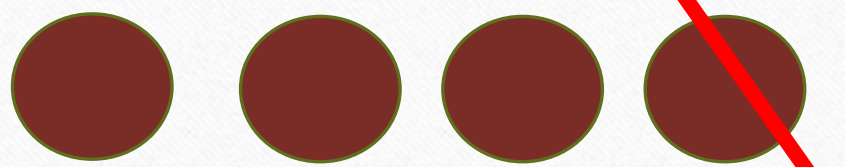
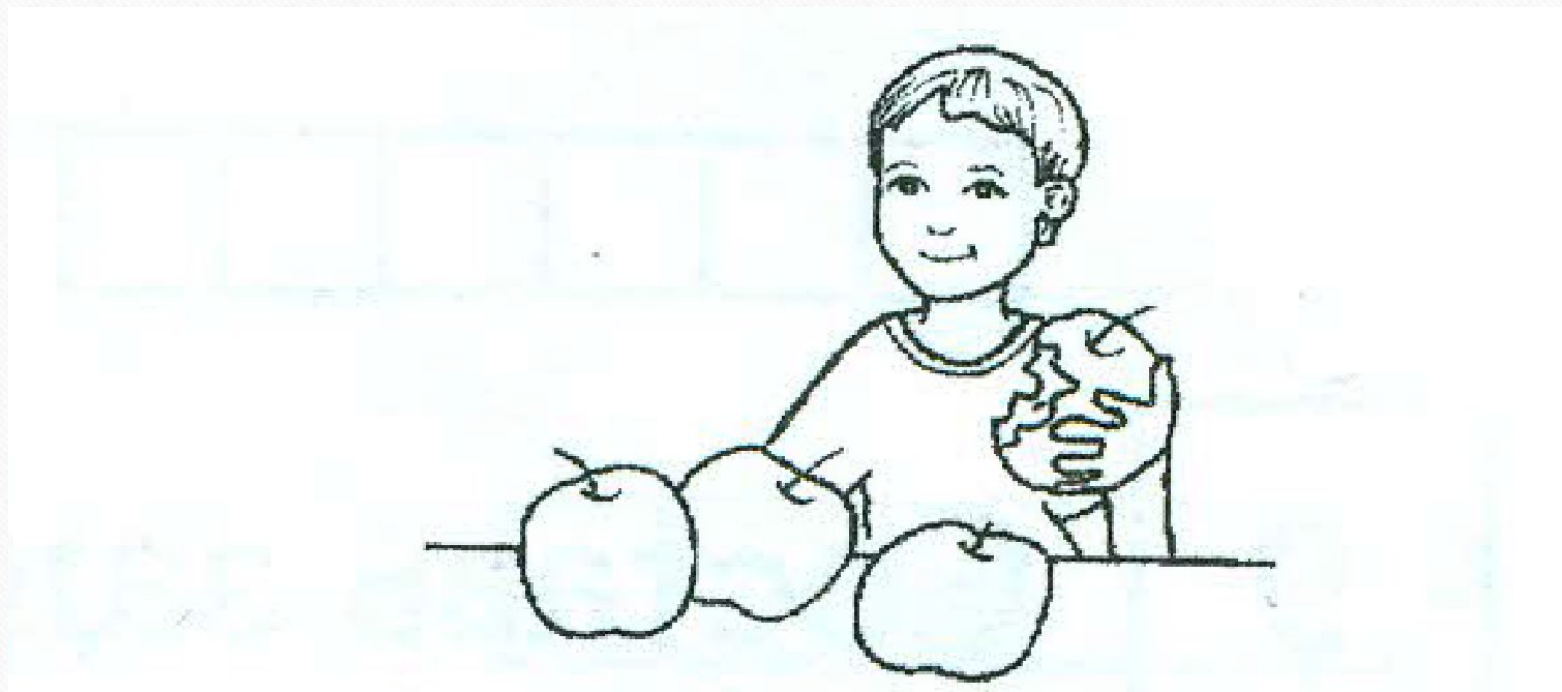

$$4 - 1 = 3$$

