

«В ПОГОНЕ ЗА СКИФАМИ» ОТЧЕТ ПО ОБЪЕКТУ №6 (МАНЖЕРОК – 12)



Выполнила бригада №4:

- 1)Дудницкая Анна
- 2)Шалимова Елена
- 3)Иванов Стас
- 4)Макаренко Владимир
- 5)Агранов Григорий

Манжерок - 12

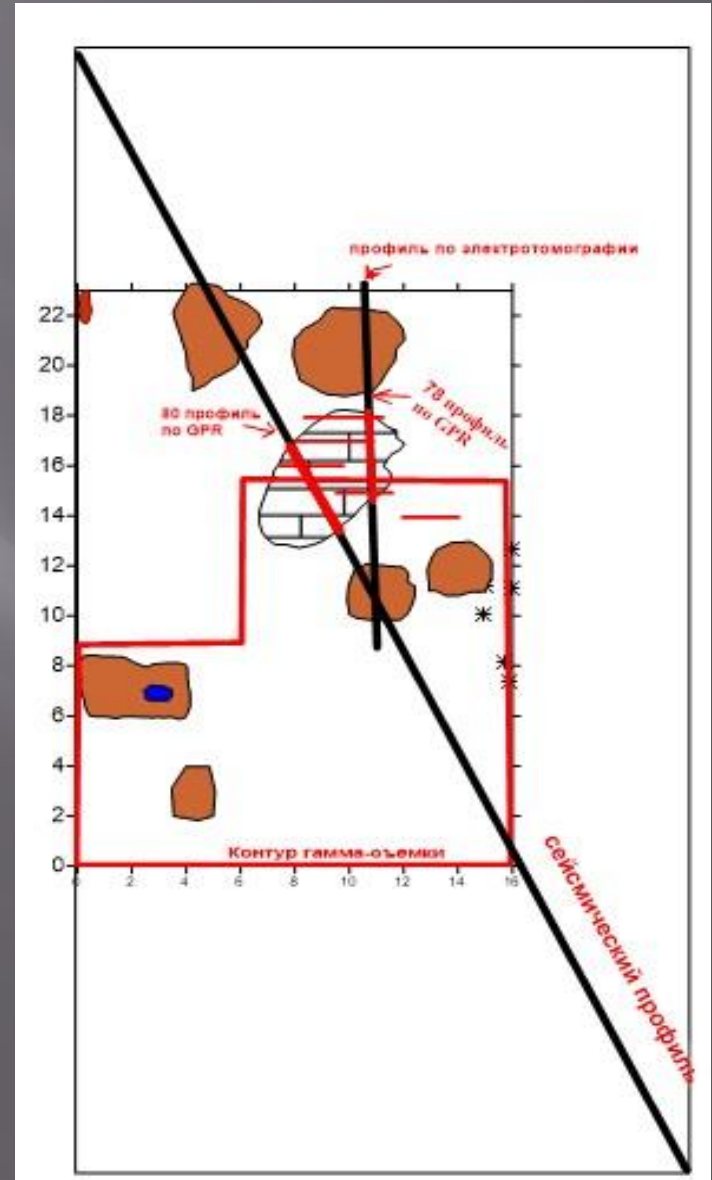

Магниторазведка



Результаты магниторазведки

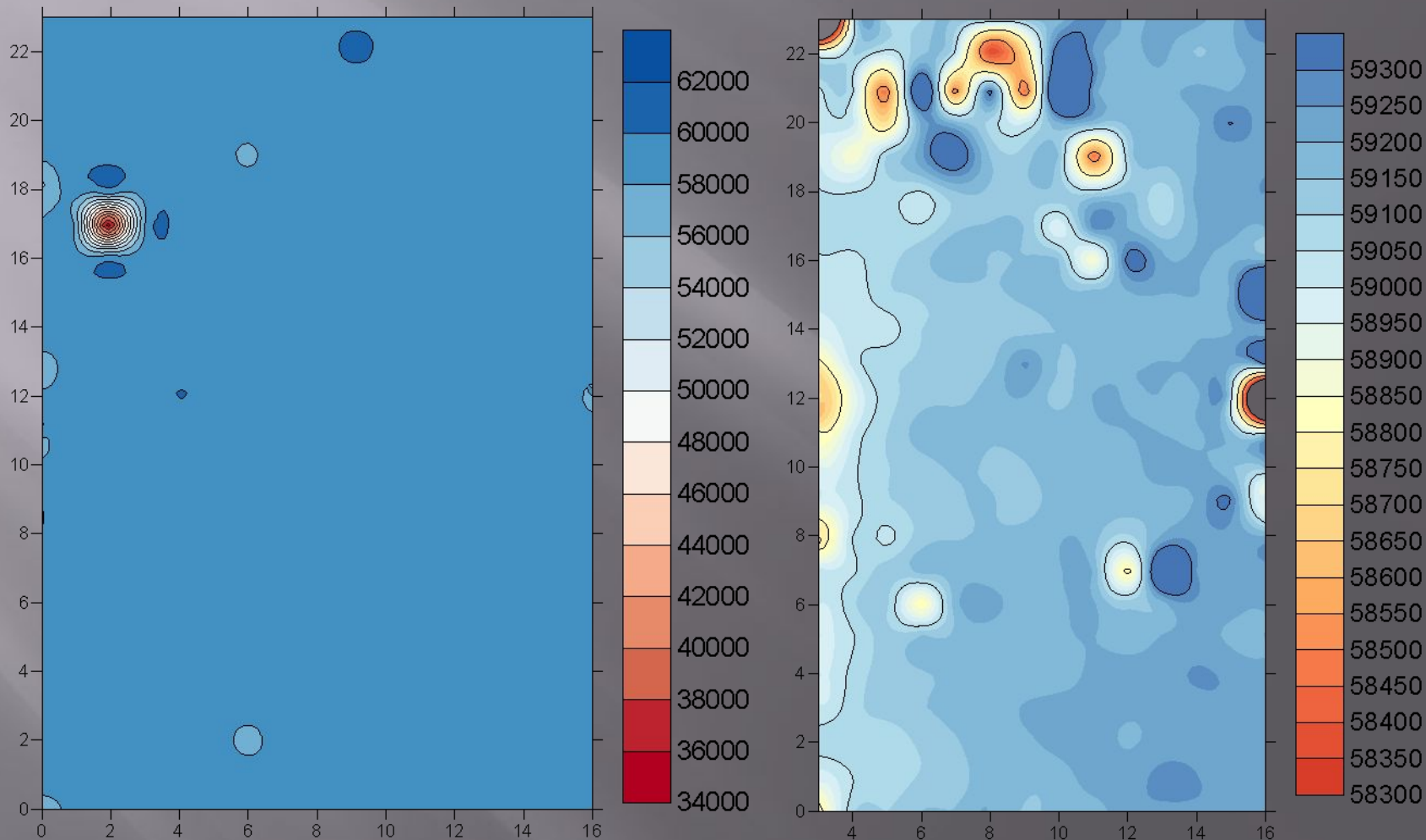

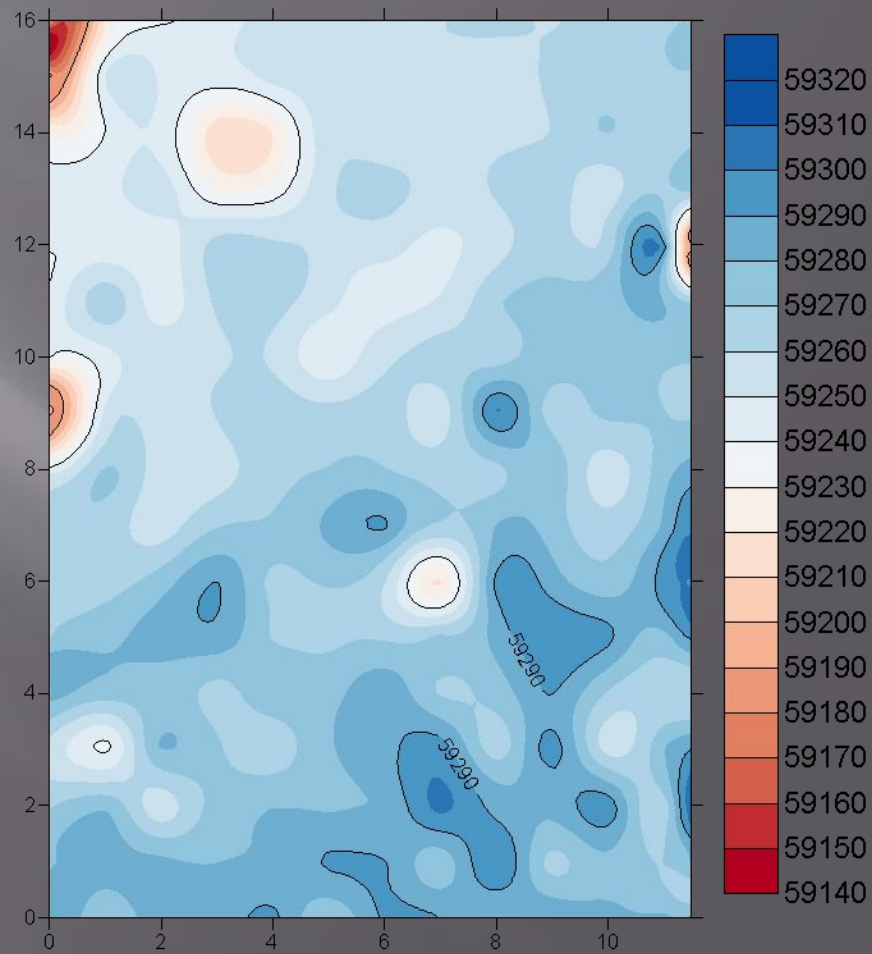
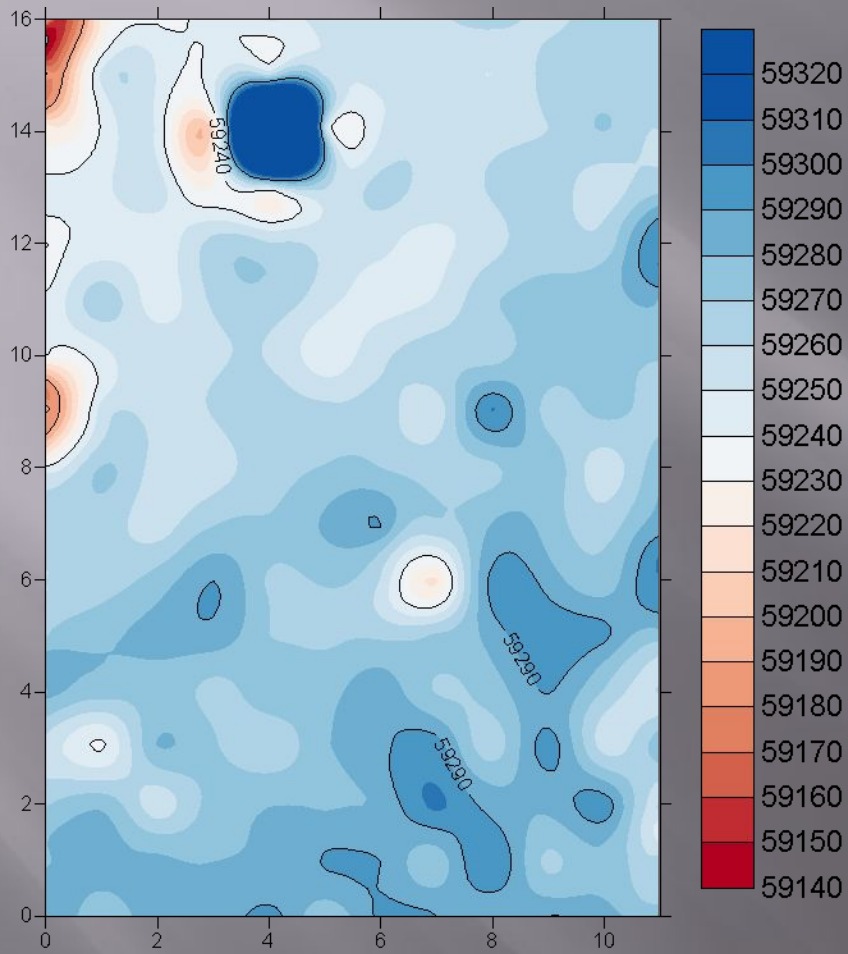

ЭМС(NEMFIS)

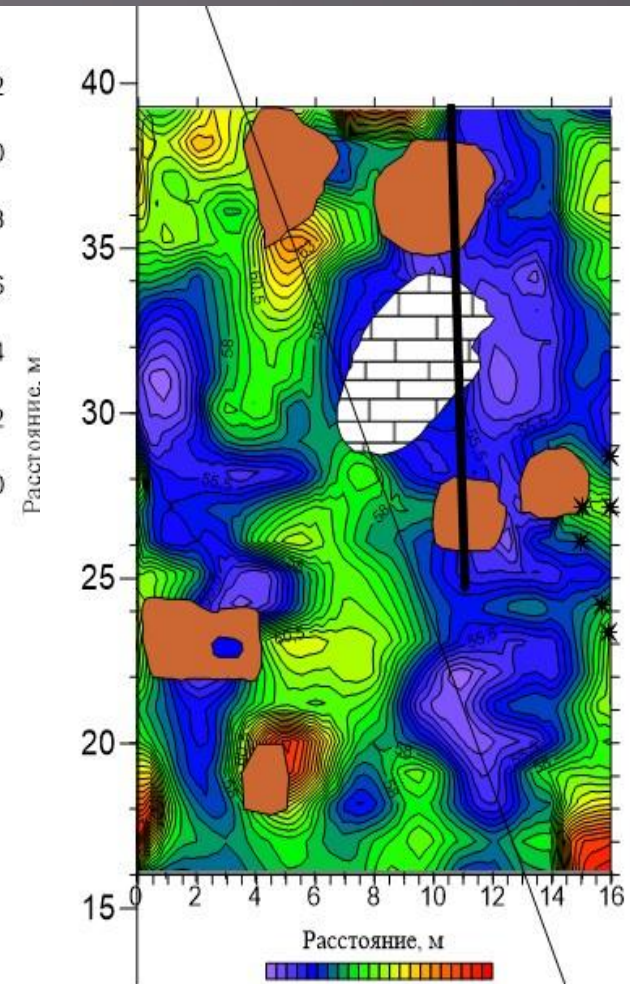
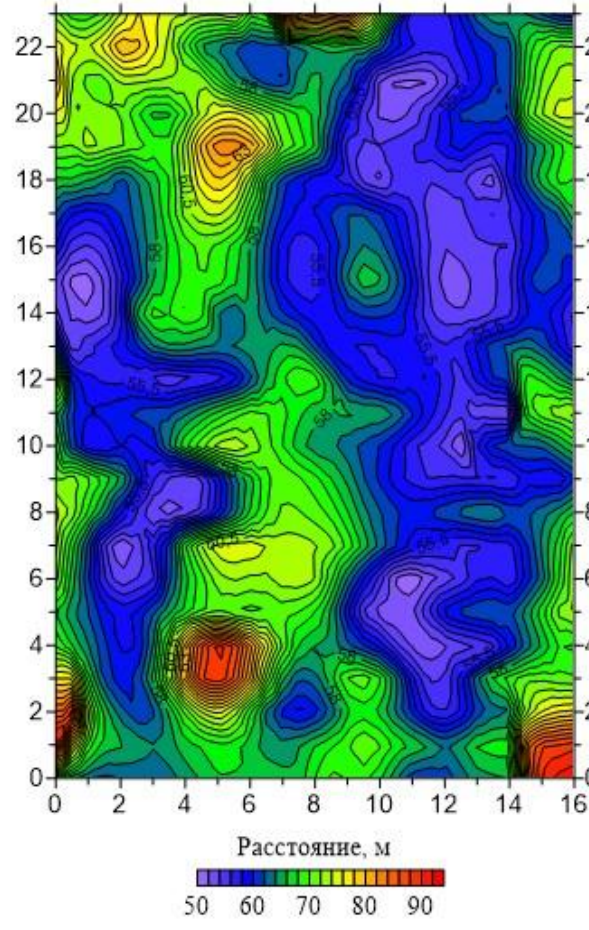
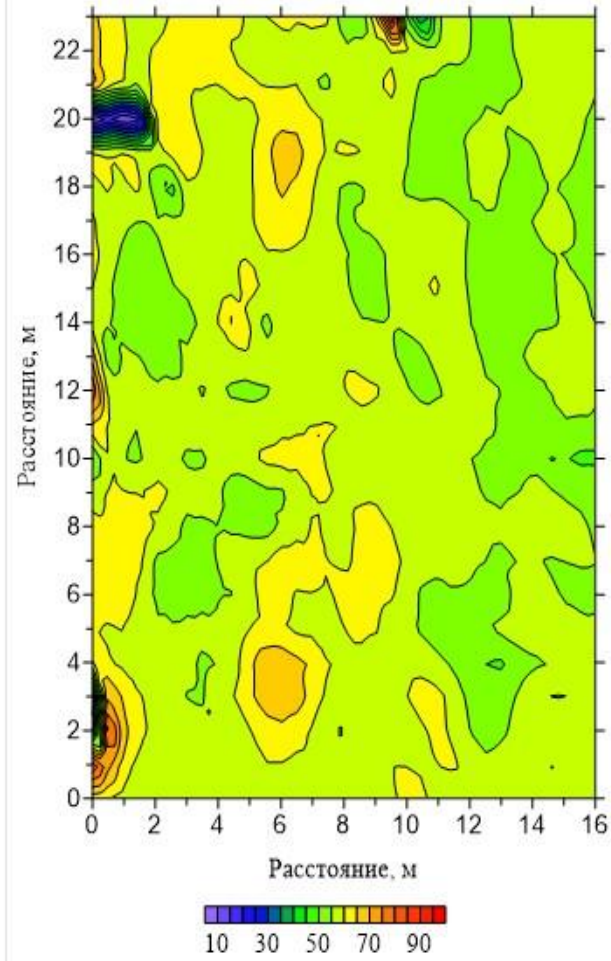

Мы за
работой!



Электротомография

Установка Шлюмберже (Schlumberger)

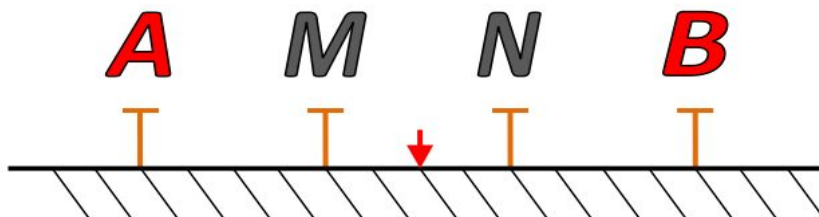

Разнос	Точка записи	Характеристики
AB	центр MN	$AM = NB = Q, Q \geq MN$



Результат электротомографии

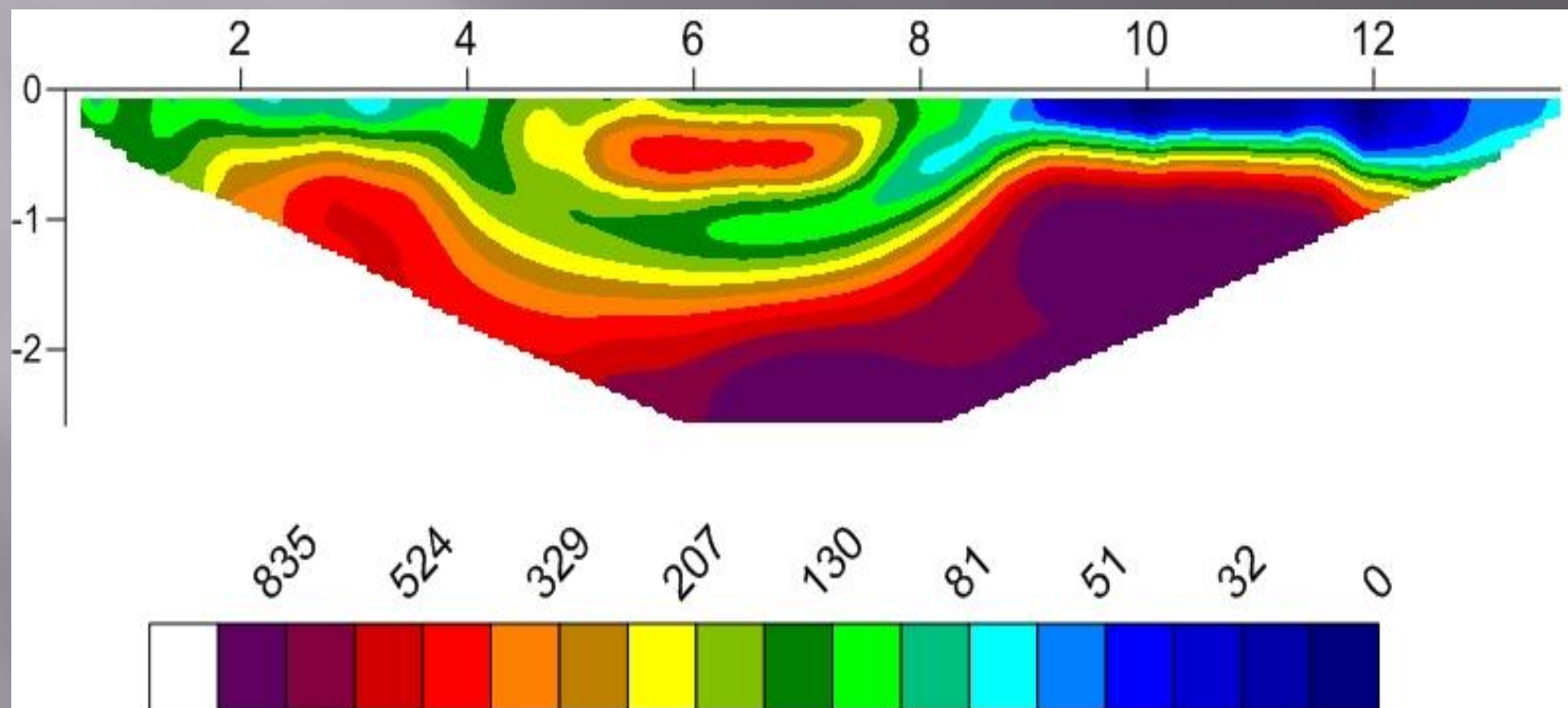

GPR



Результаты GPR

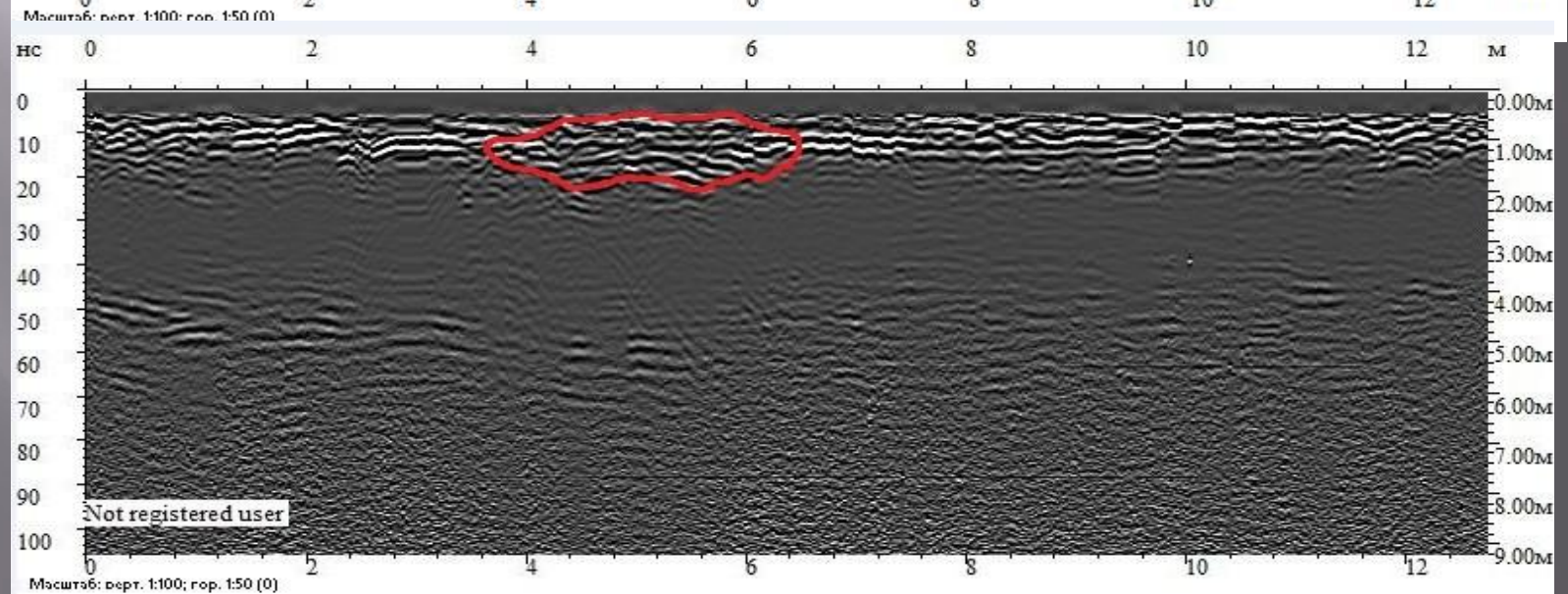
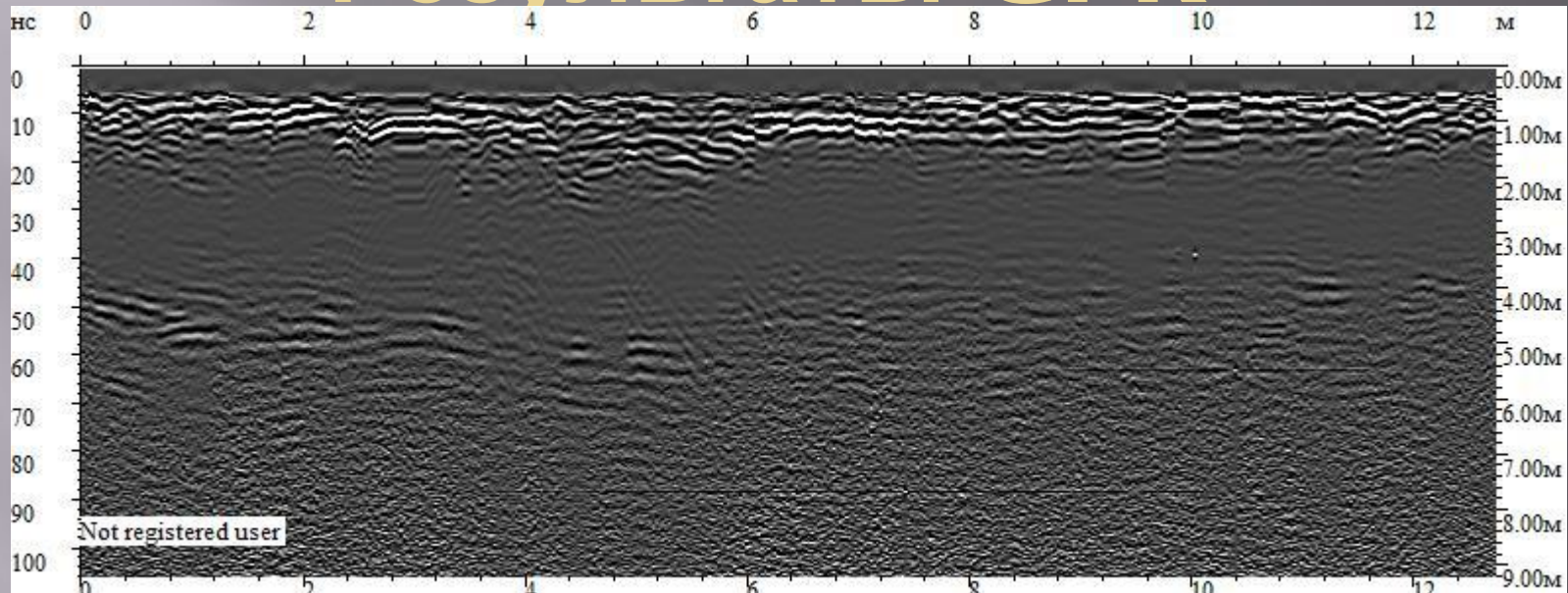

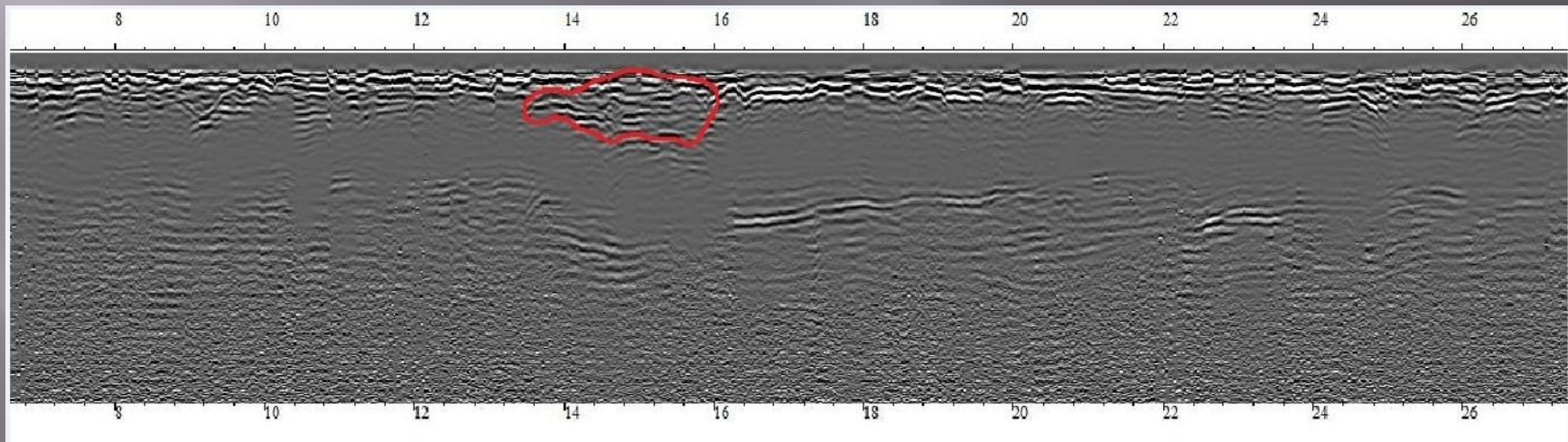
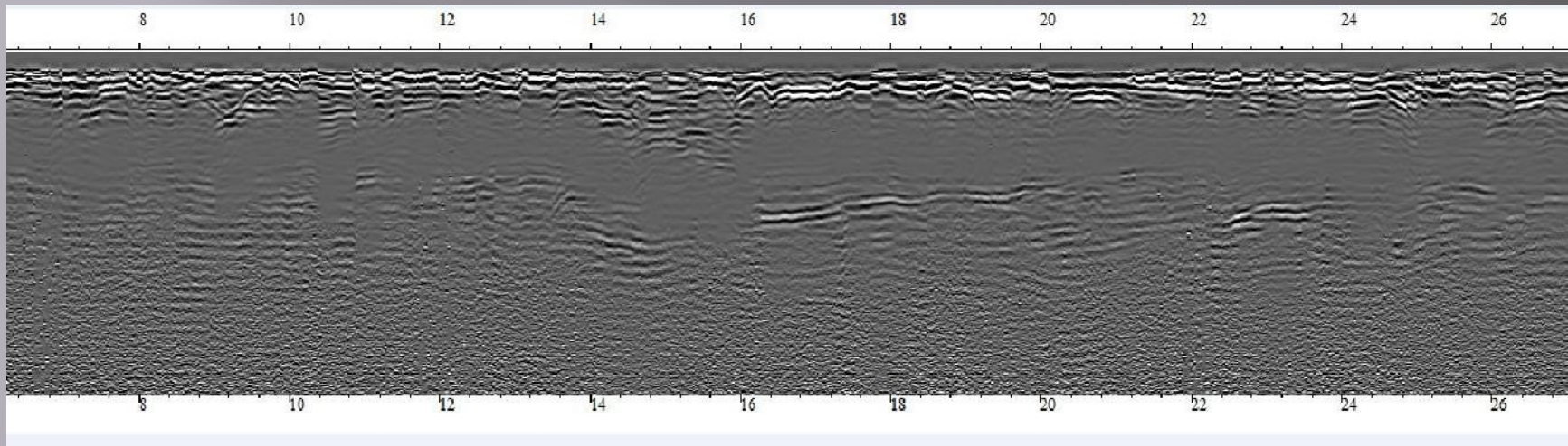

MASW

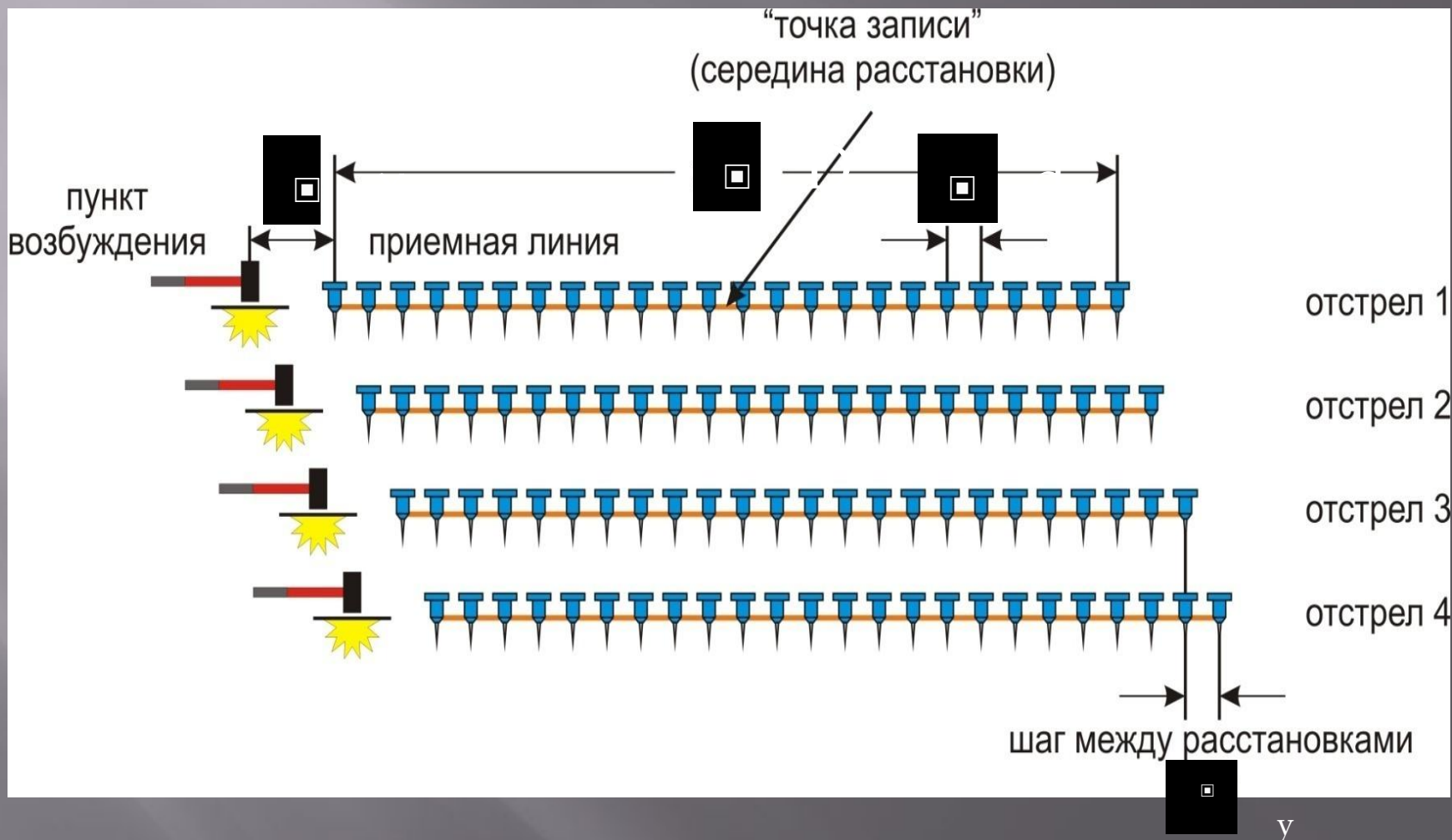

Результаты MASW

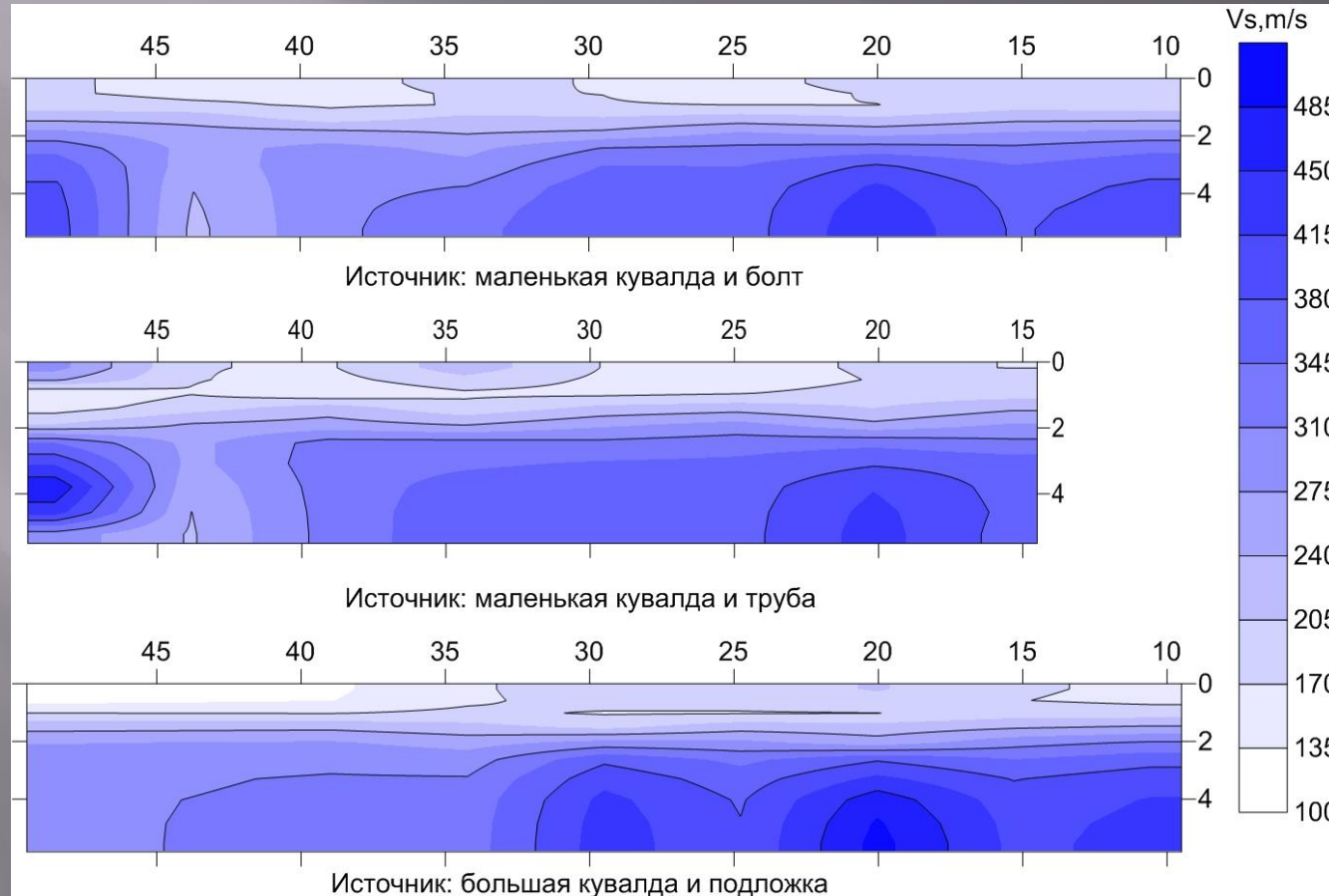

Метод сейсмической томографии

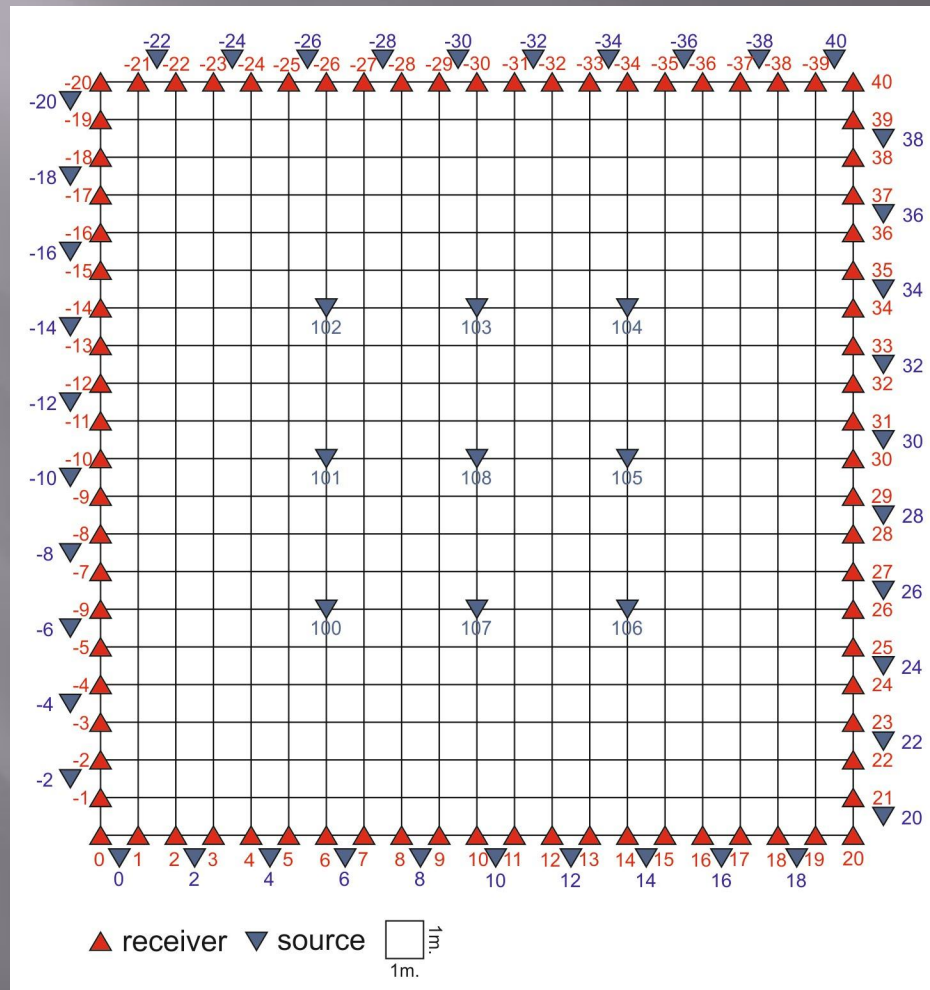

Радиометрия



Результат радиометрии

