

*Решение задач  
на готовых чертежах.  
Четырёхугольники.*

*Геометрия.  
8 класс.*

*Каратанова Марина Николаевна  
МОУ СОШ №256 г.Фокино*



**1**

**2**

**3**

**4**

**5**

**6**

**7**

**8**

**9**

**10**

**11**

**12**

**13**

**14**

**15**

**16**

**17**

**18**

**19**

**20**

**21**

**22**

**23**

**24**

**25**

**26**

**27**

**28**

**29**

**30**

**31**

**32**

**33**

**34**

**35**

**36**

1.

*Дано:*

$AB \parallel CD; BC \parallel AD$

*Доказать:*

$BC = AD; \angle A = \angle C$

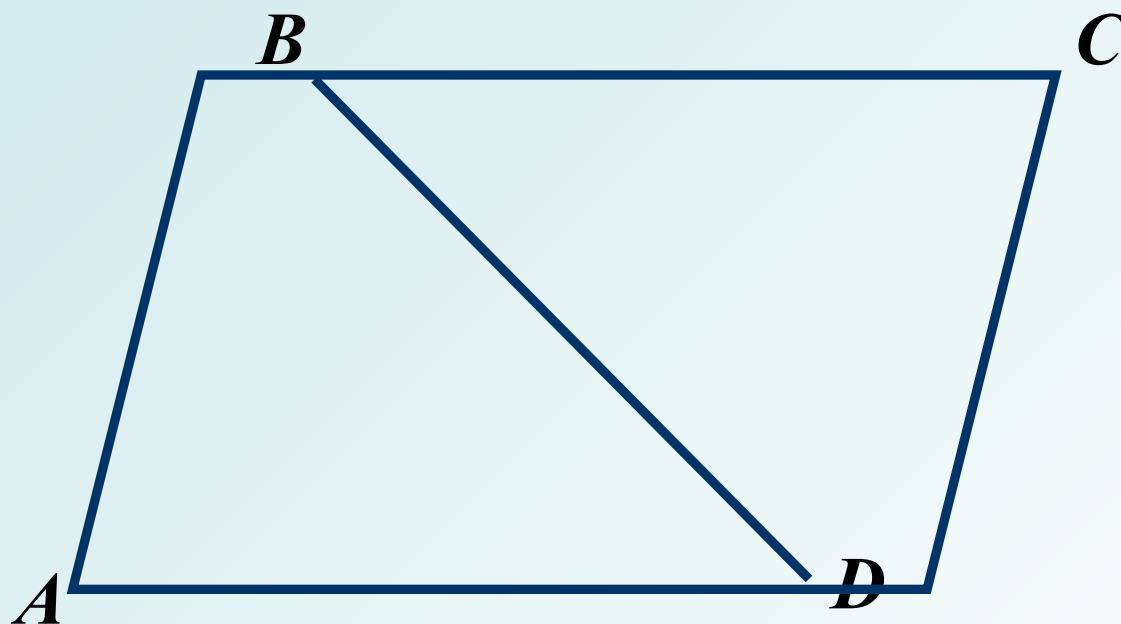

2.

**Дано:**  $AB \parallel CD$ ;  $AB = CD$

**Доказать:**  $O$  – середина  $AC$  и  $BD$

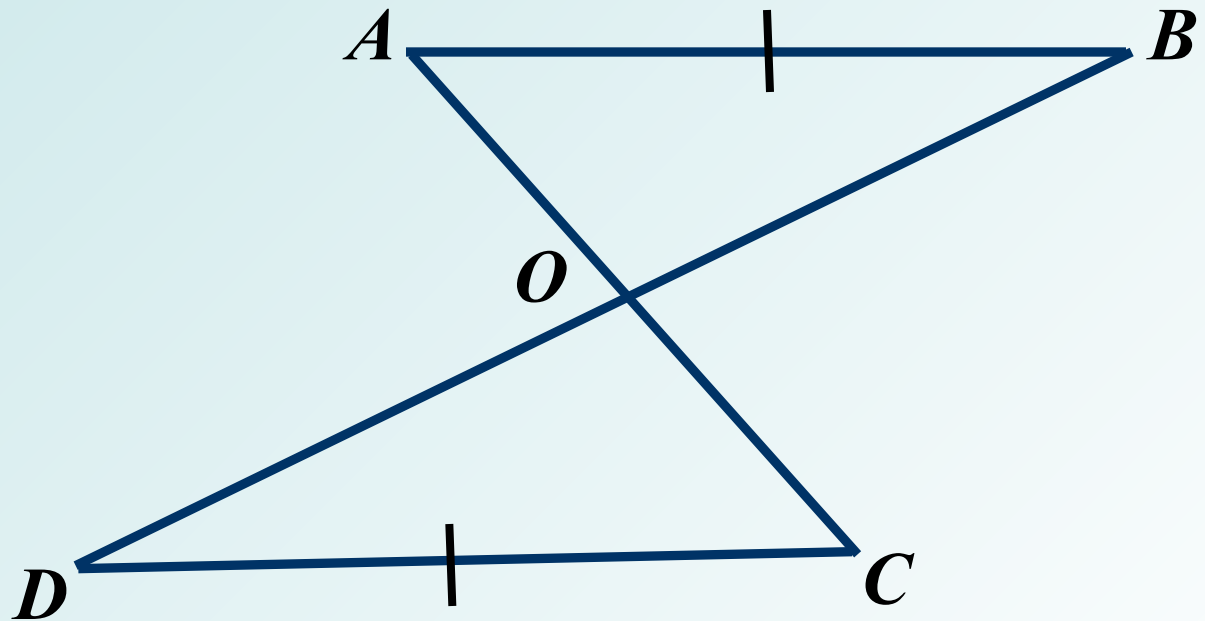

3.

**Дано:**

$$\angle 1 = \angle 2, \quad \angle 3 = \angle 4$$

**Доказать:**

$ABCD$  – параллелограмм

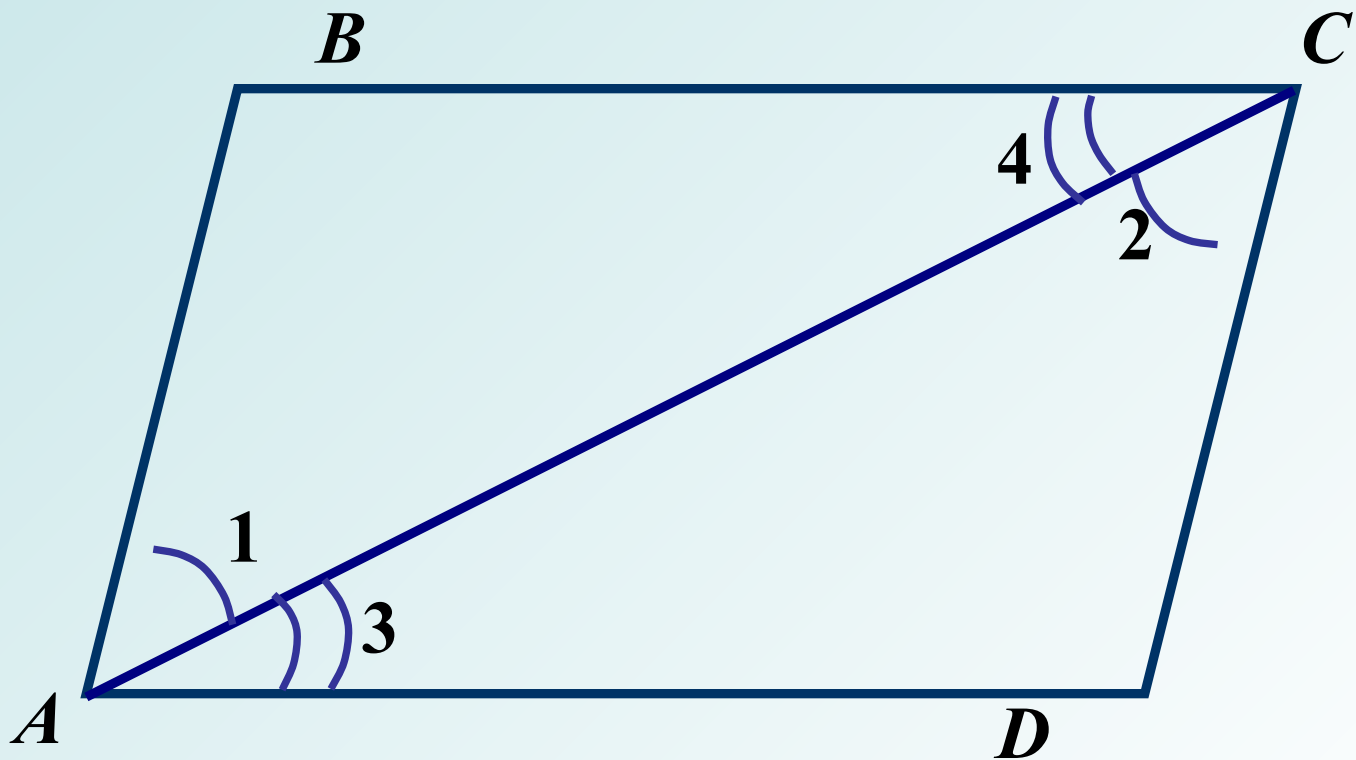

4.

**Дано:**

$MNPQ$ ,  $\angle M = \angle P$

**Доказать:**

$MNPQ$  – *прямоугольник*

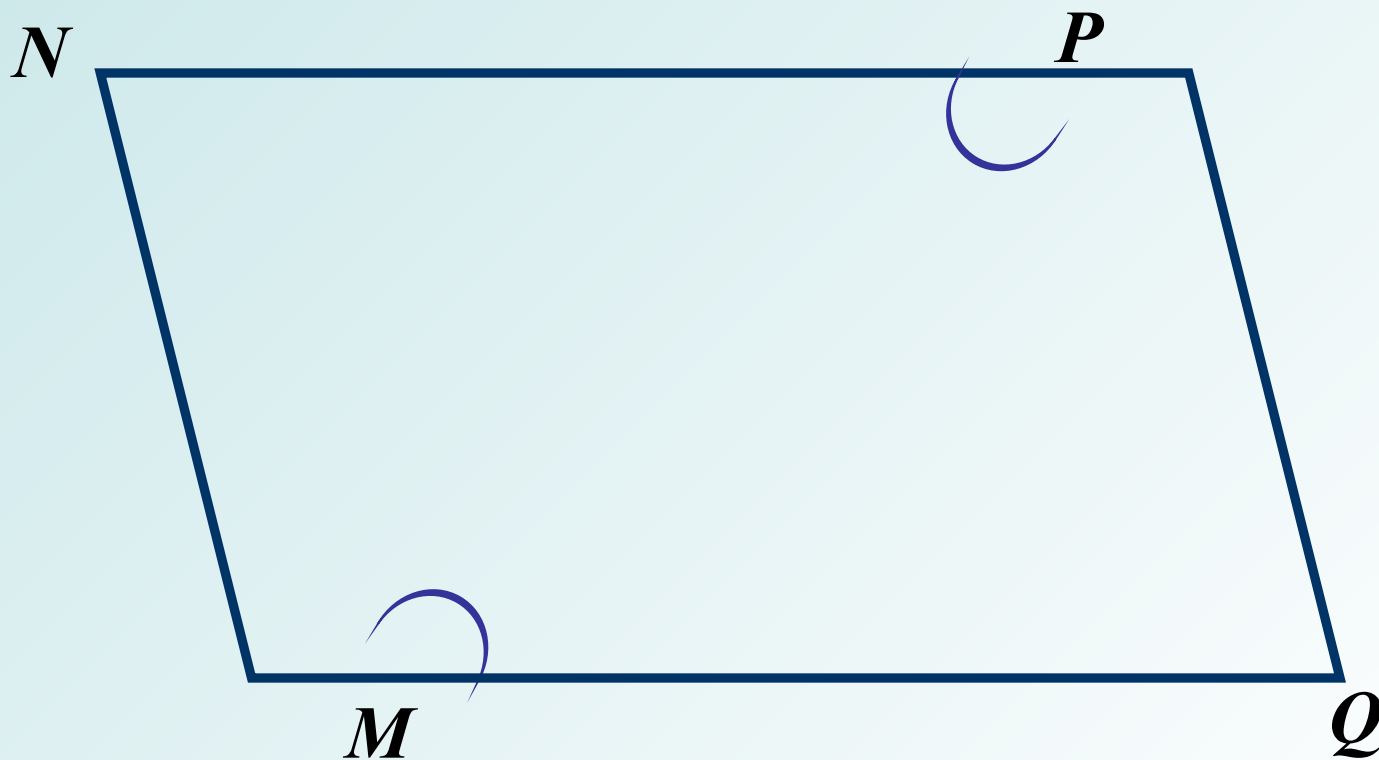

5.

**Дано:**

$$\angle 1 = \angle 2 = \angle 3$$

**Доказать:**

$ABCD$  – параллелограмм

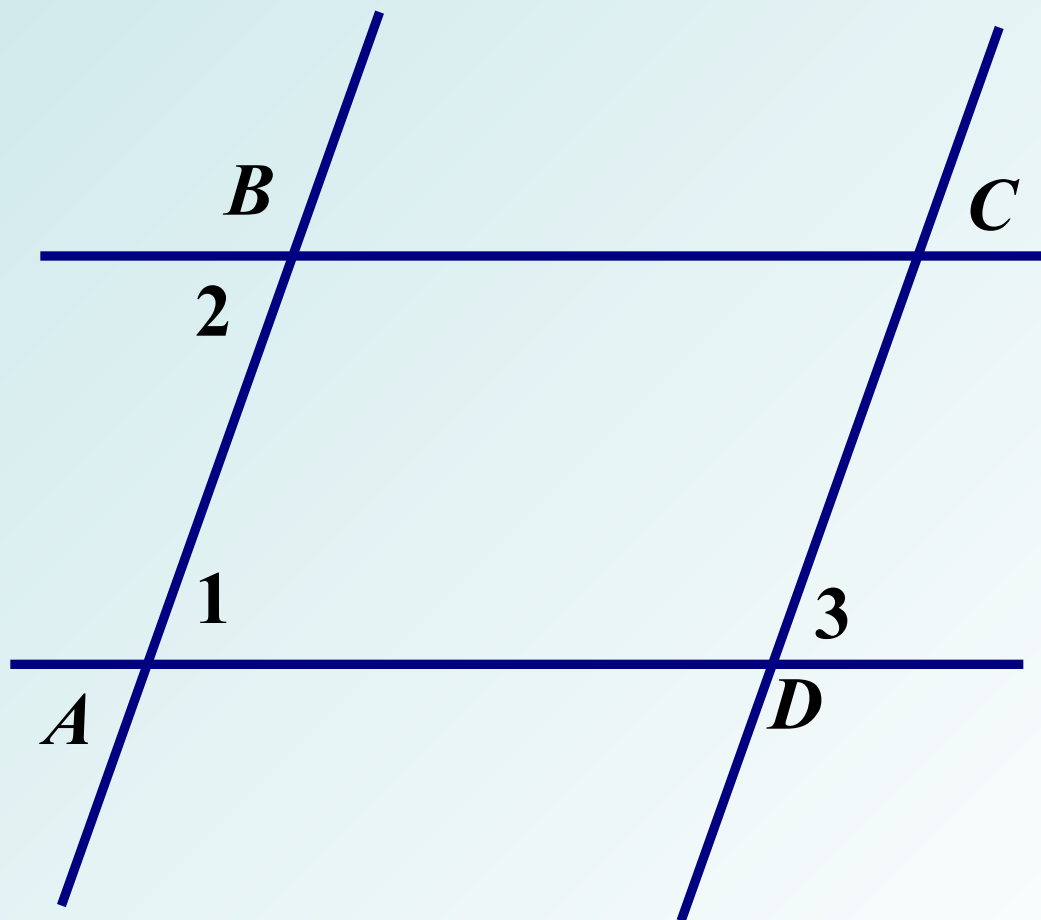

6.

**Дано:**

a)  $\angle 1 = 70^\circ$ ;  $\angle 3 = 110^\circ$ ;  $\angle 2 + \angle 3 = 180^\circ$

á)  $\angle 1 = \angle 2$ ;  $\angle 2 \neq \angle 4$

**Вопрос:**

βâëÿãòñÿ èè ABCD ìàðàëëãëïã ðàìì

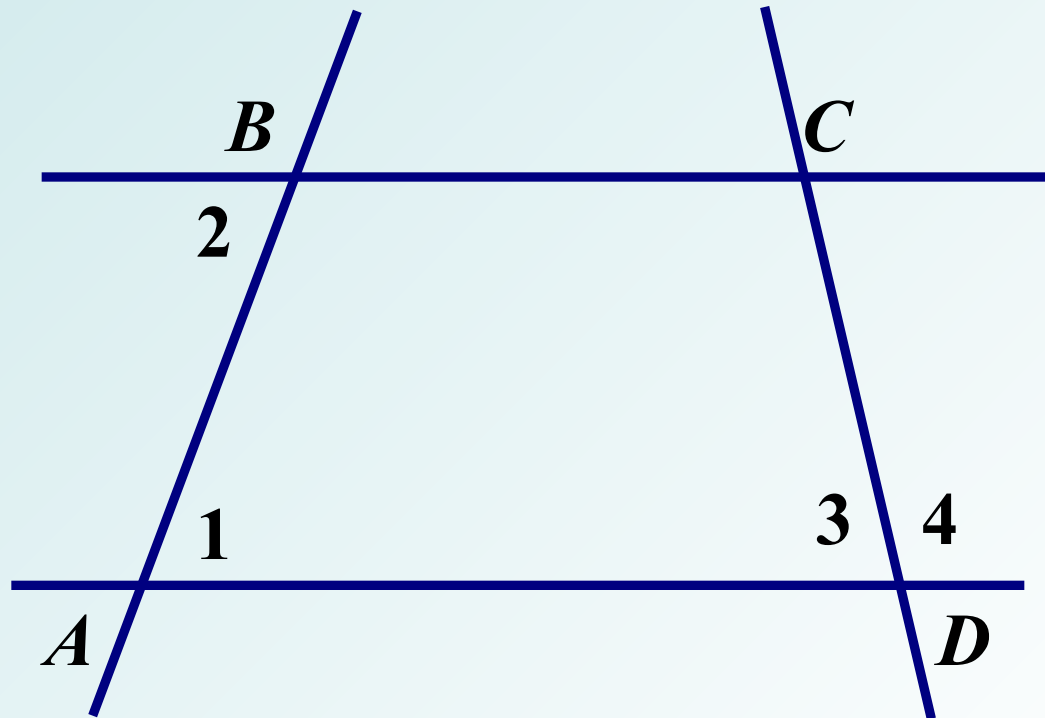



7.

**Дано:**  $ABCD$  – параллелограмм

**Найти:**  $\angle C, \angle D$

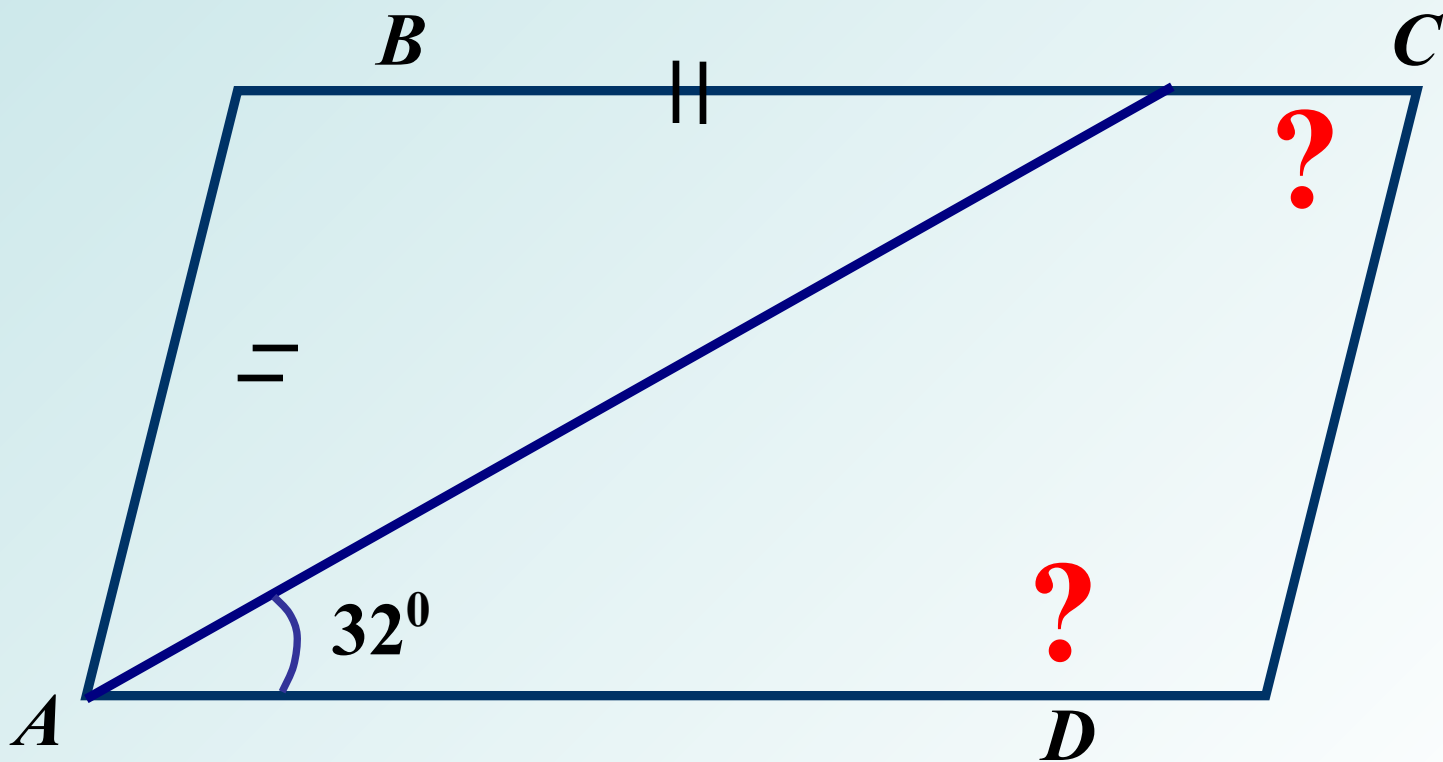

8.

Дано:  $MNKP$  –  $\text{прямоугольник}$

Найти:  $MP$ ;  $PK$

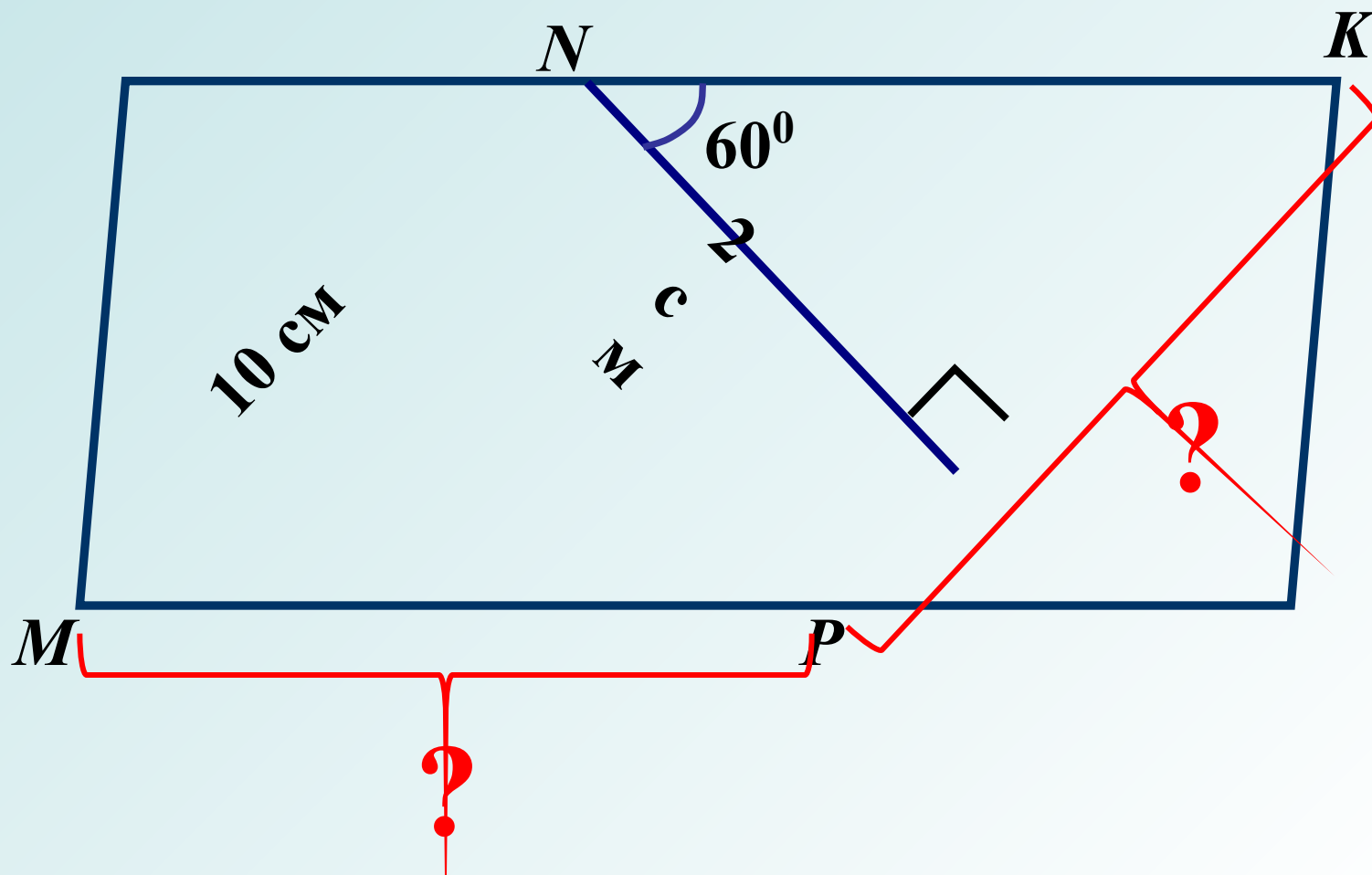

9.

**Найти:**

*óãëû ìàðàëëäëîã ðàìà ABCD*

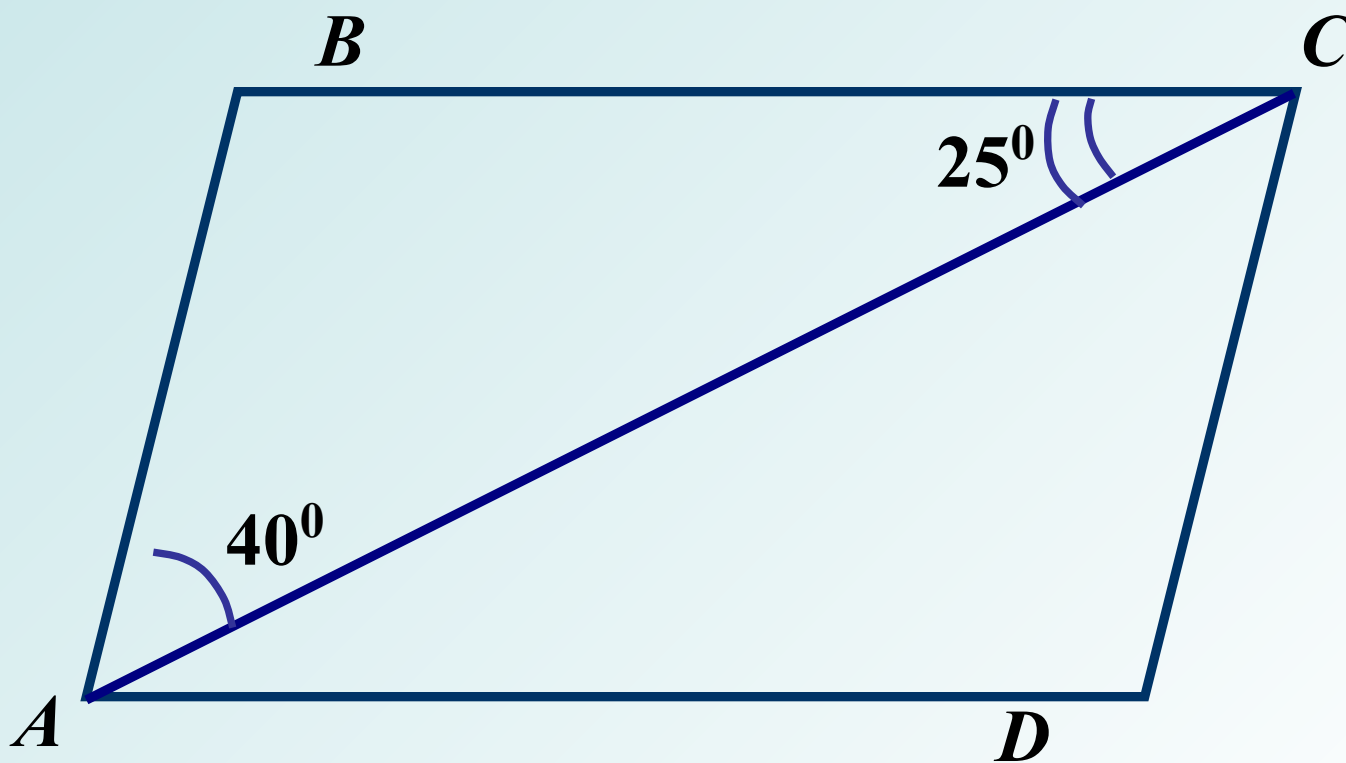

10.

Дано:  $ABCD$  –  $\text{ïàðàëëäëïã ðàìì}$

Найти:  $P_{ABCD}$

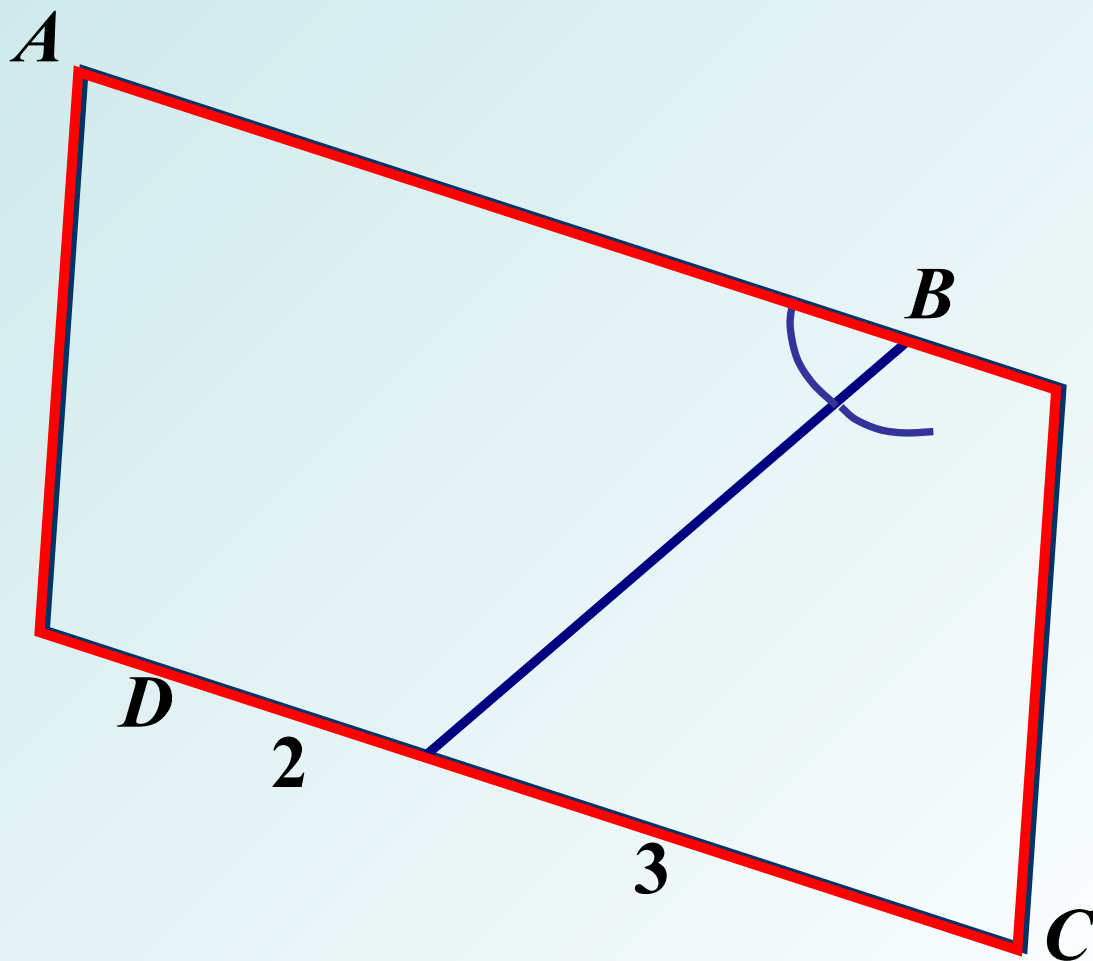

11.

Дано:  $ABCD$  – параллелограмм

Найти:  $AD$

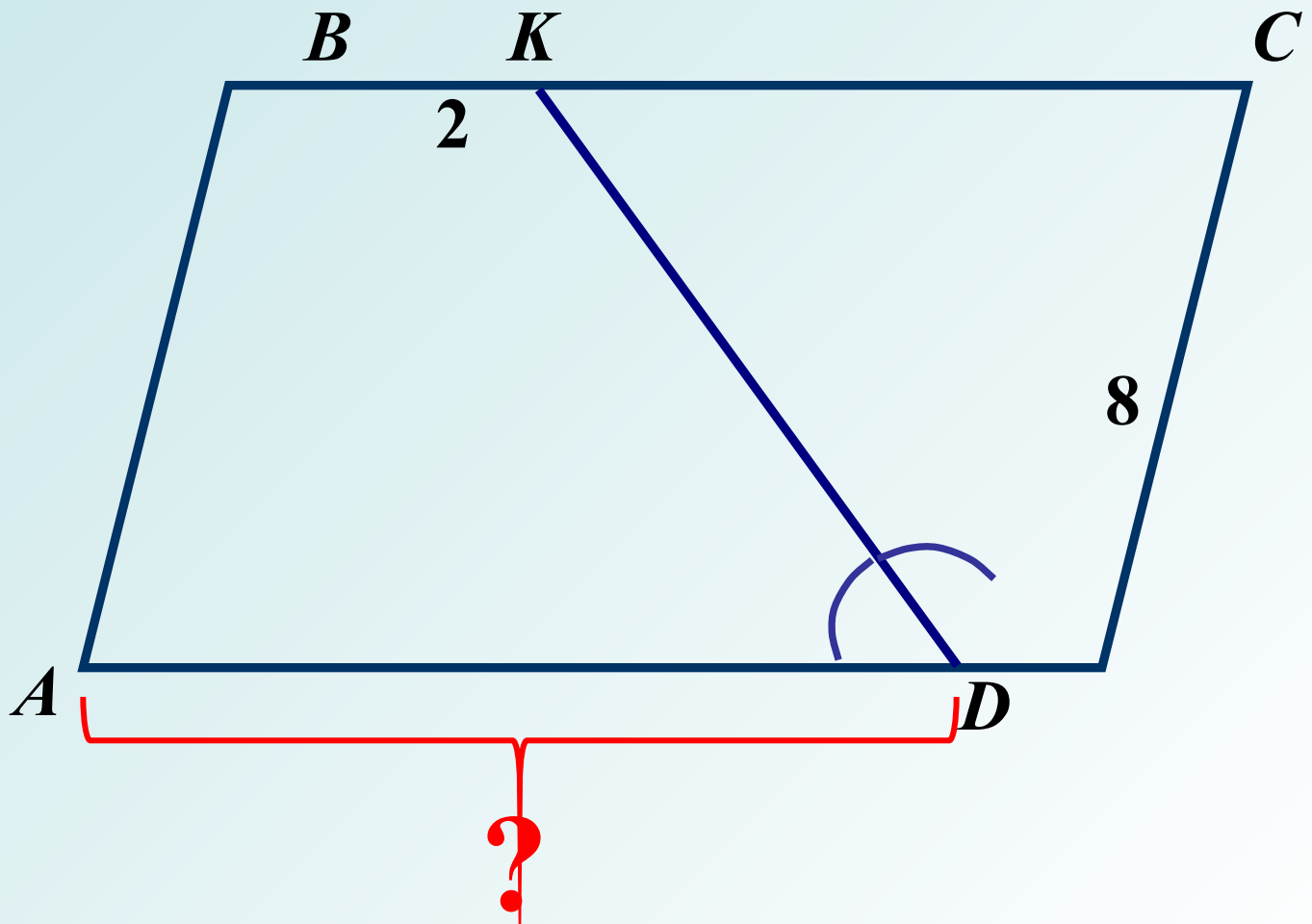

12.

**Дано:**  $ABCD$  –  $\text{ïàðàëëäëïã ðàì}$

**Найти:**  $P_{ABCD}$ ,  $\angle AED$

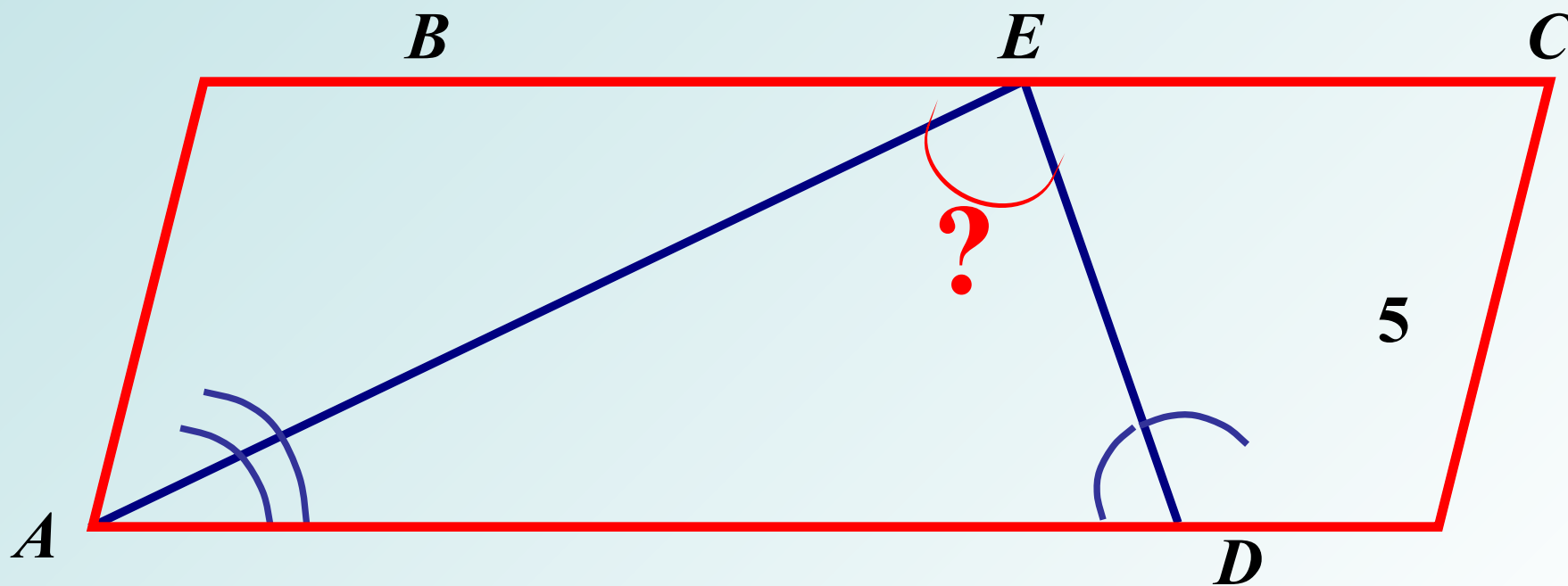

13.

**Дано:**  $NBFD$  – трапеция  
 $AD = 4$  см,  $NB = 5$  см

**Найти:**  $AN$ ,  $CD$

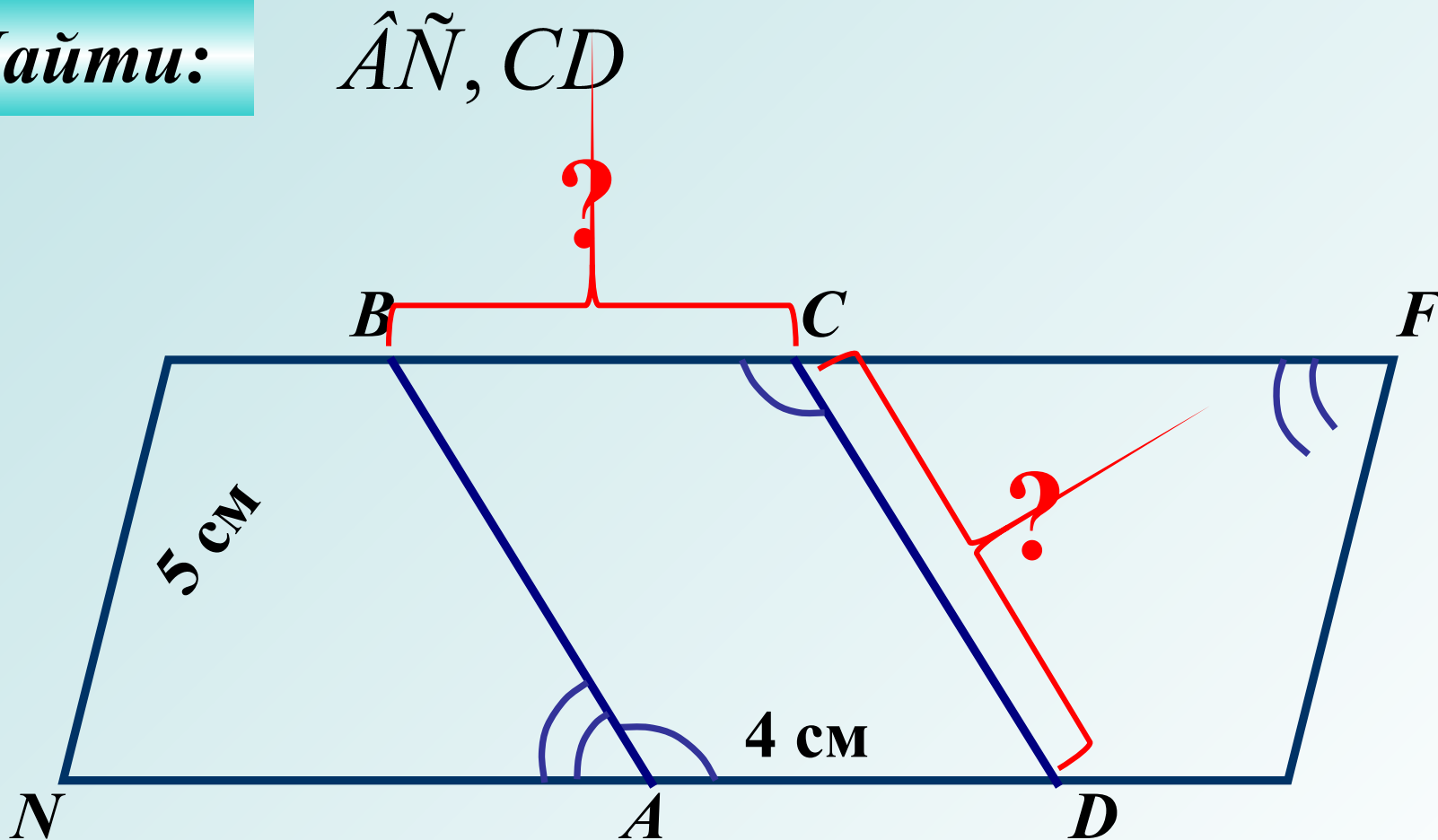

14.

**Дано:**  $ABCD$  – параллелограмм

$$P_{MNKP} = 20 \text{ см}^2$$

**Найти:**  $MN, MP$

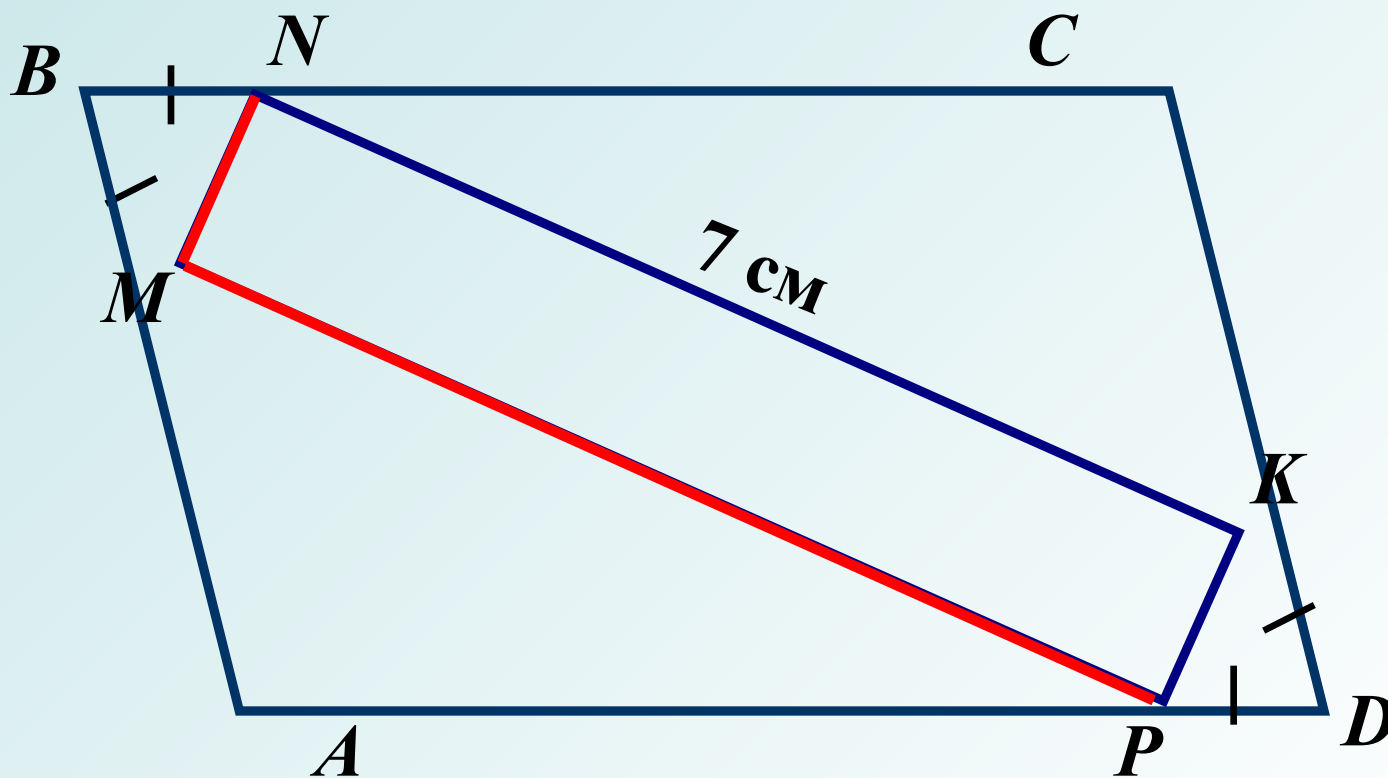



15.

**Дано:**

$BNDM$  – параллелограм

$$AB : BC = 4 : 5, P_{ABCD} = 18 \text{ см}^2$$

**Найти:**

$AD, DC$

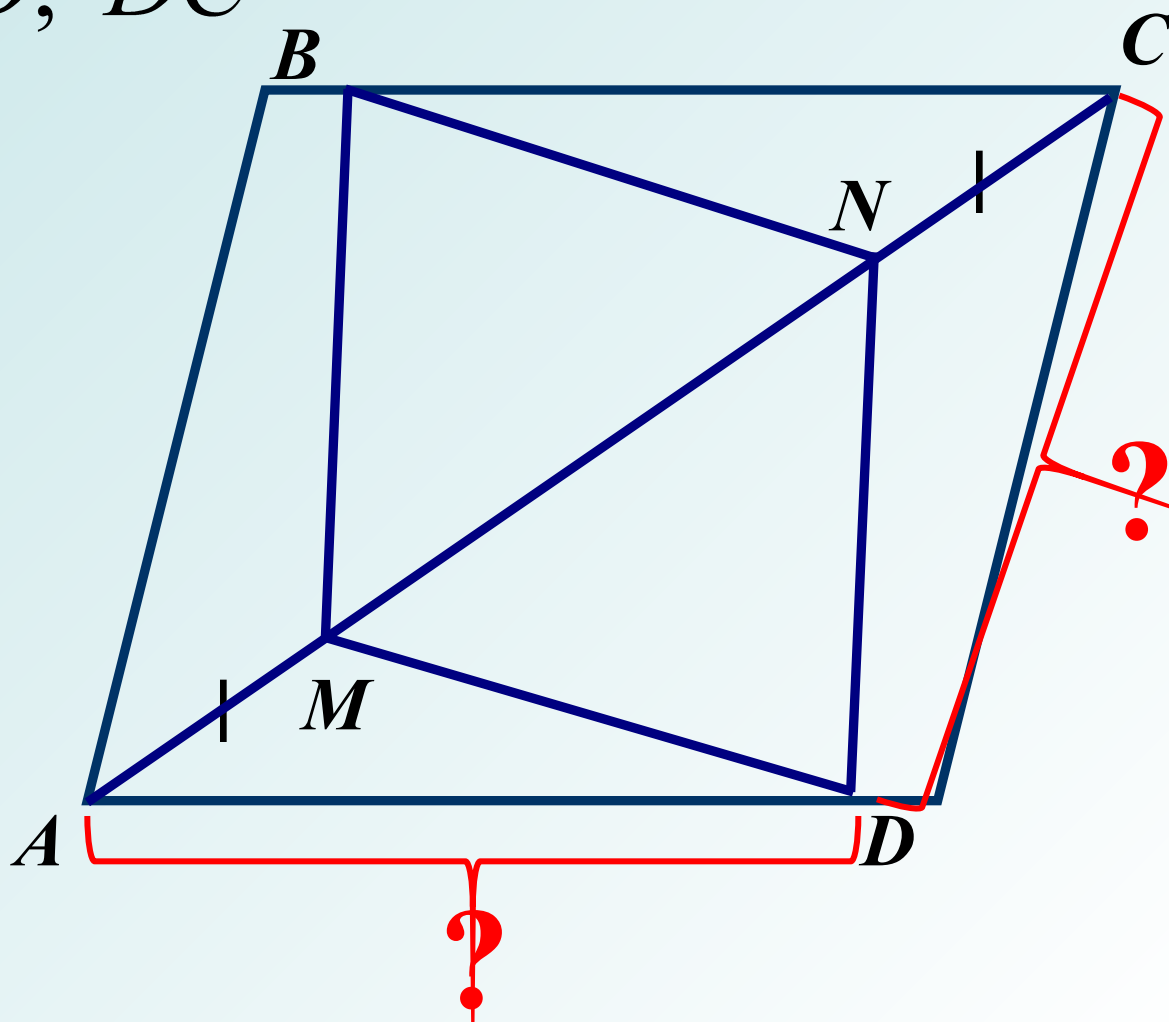

16.

Дано:  $ABCD$  – о́дàìàòöèÿ

Найти:  $\angle A_1A_2$

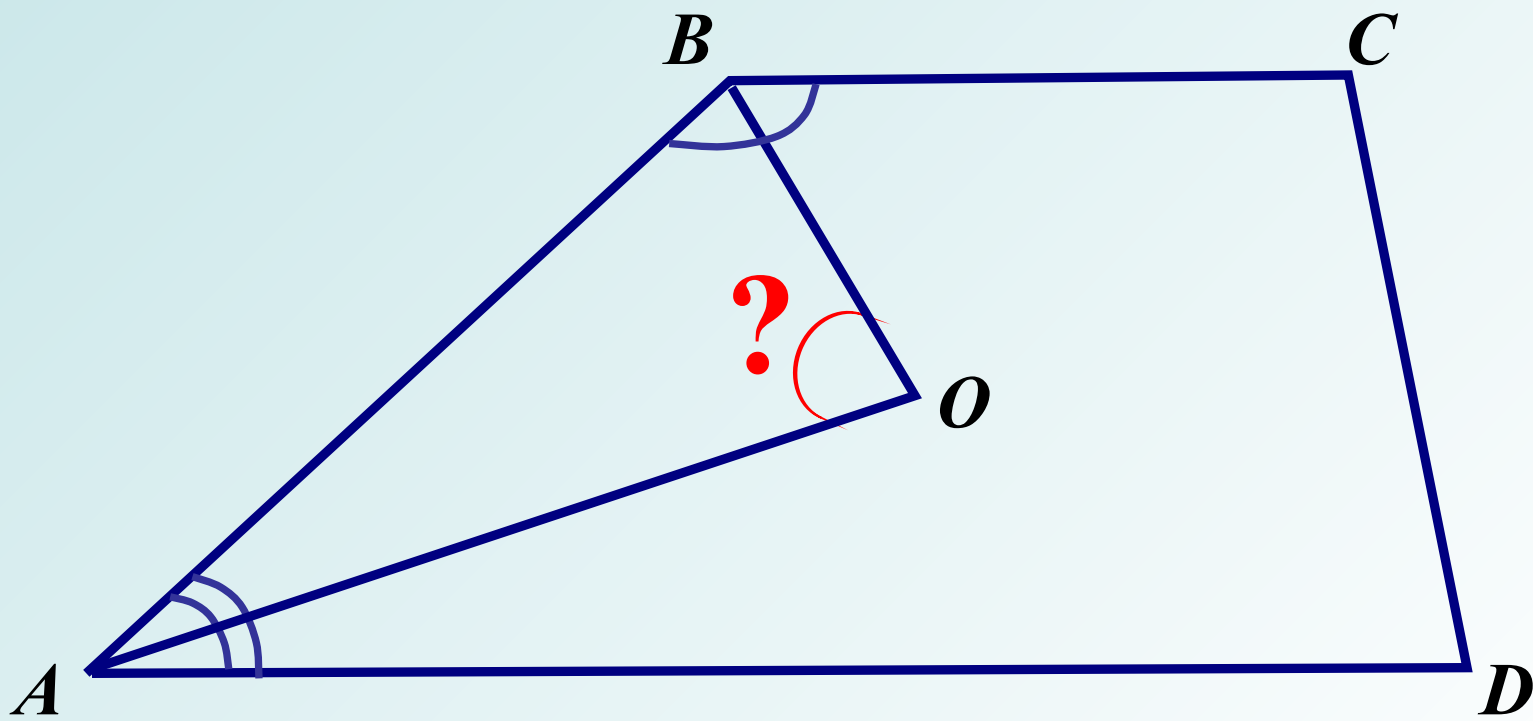

17.

**Дано:**  $ABCD$  –  $\text{òđàìáöèÿ}$

**Найти:**

$\text{óãëÿ òđàìáöèè}$

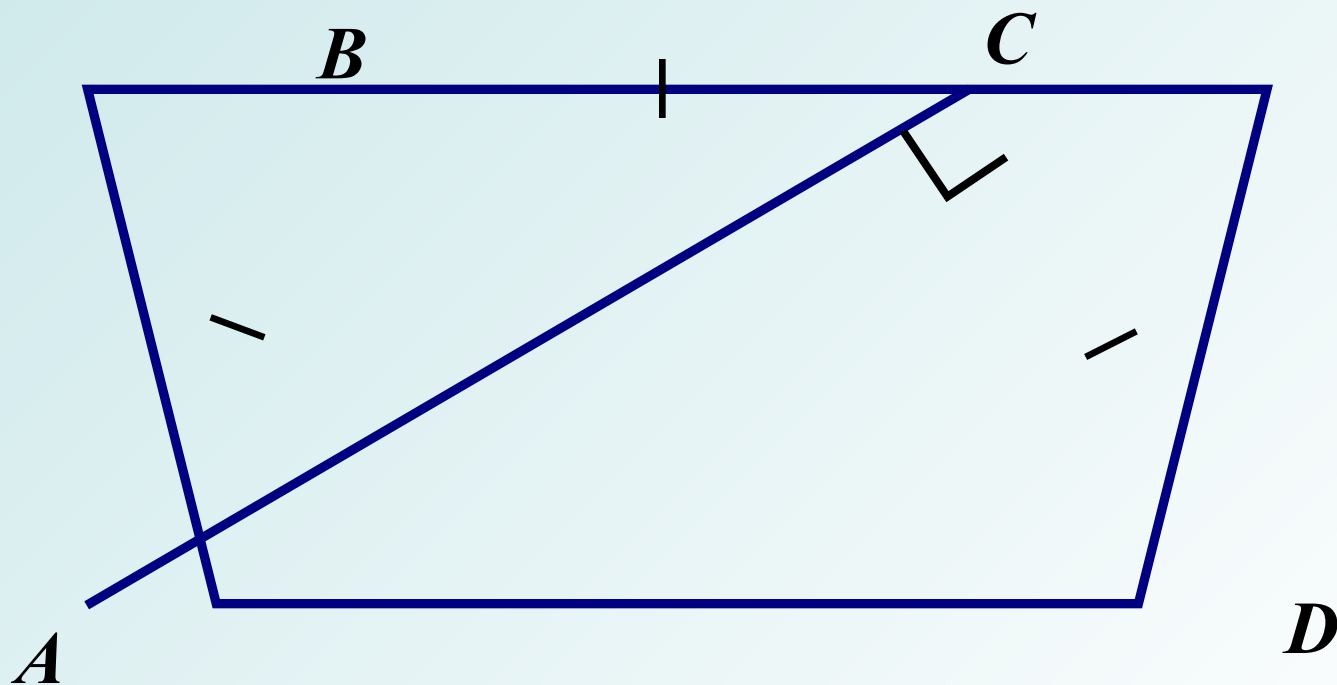

18.

Дано:

$ABCD$  – трапеция  $BA \parallel CD$

Найти:

$\angle B$

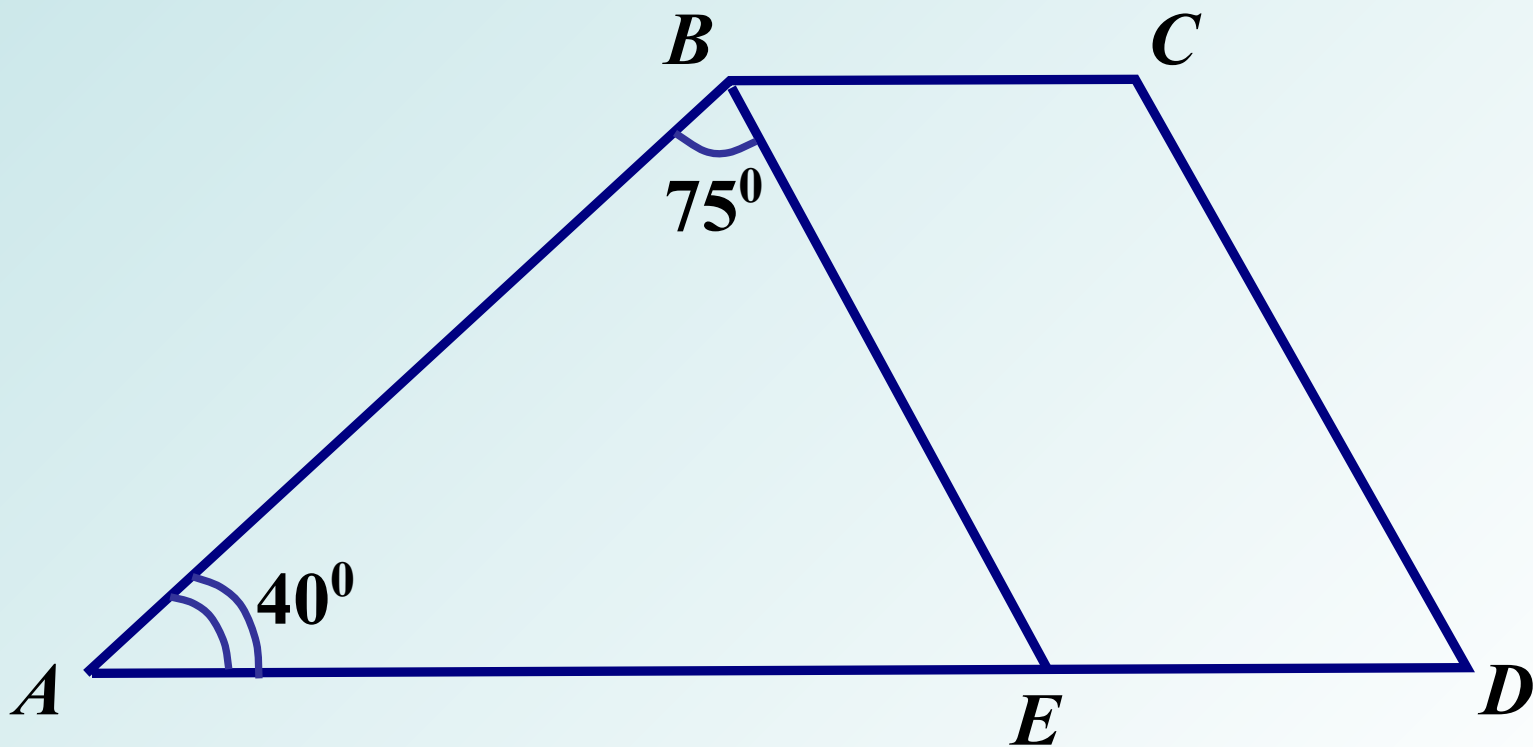

19.

Дано:

$ABCD$  –  $\text{òđàìäöèÿ}$

Найти:

$\hat{A}\tilde{N}$

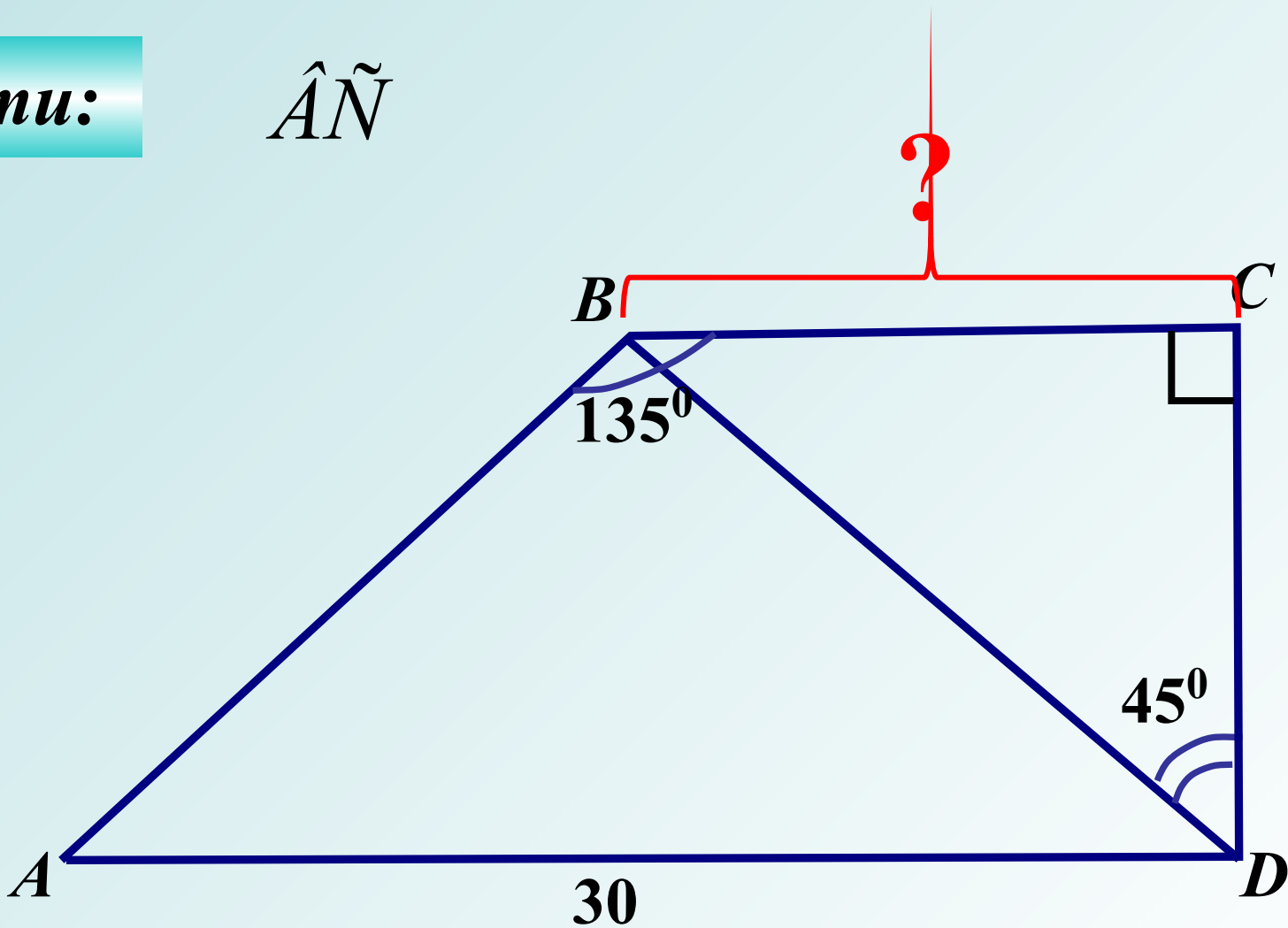

20.

Дано:

$ABCD$  – о́дàìáöèÿ  $AD = 15$

Найти:

$\tilde{NA}$

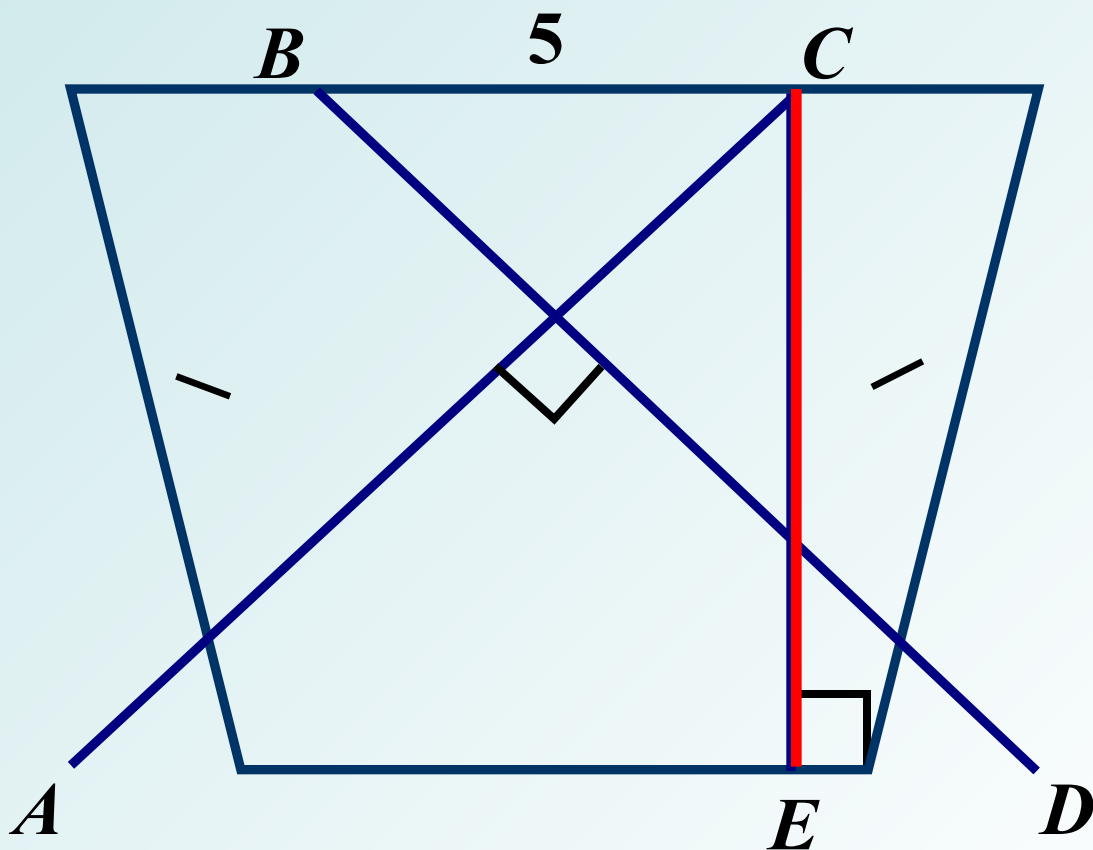

21.

**Дано:**

$ABCD$  – трапеция  $AD = 15$

**Найти:**

$P_{ABCD}$

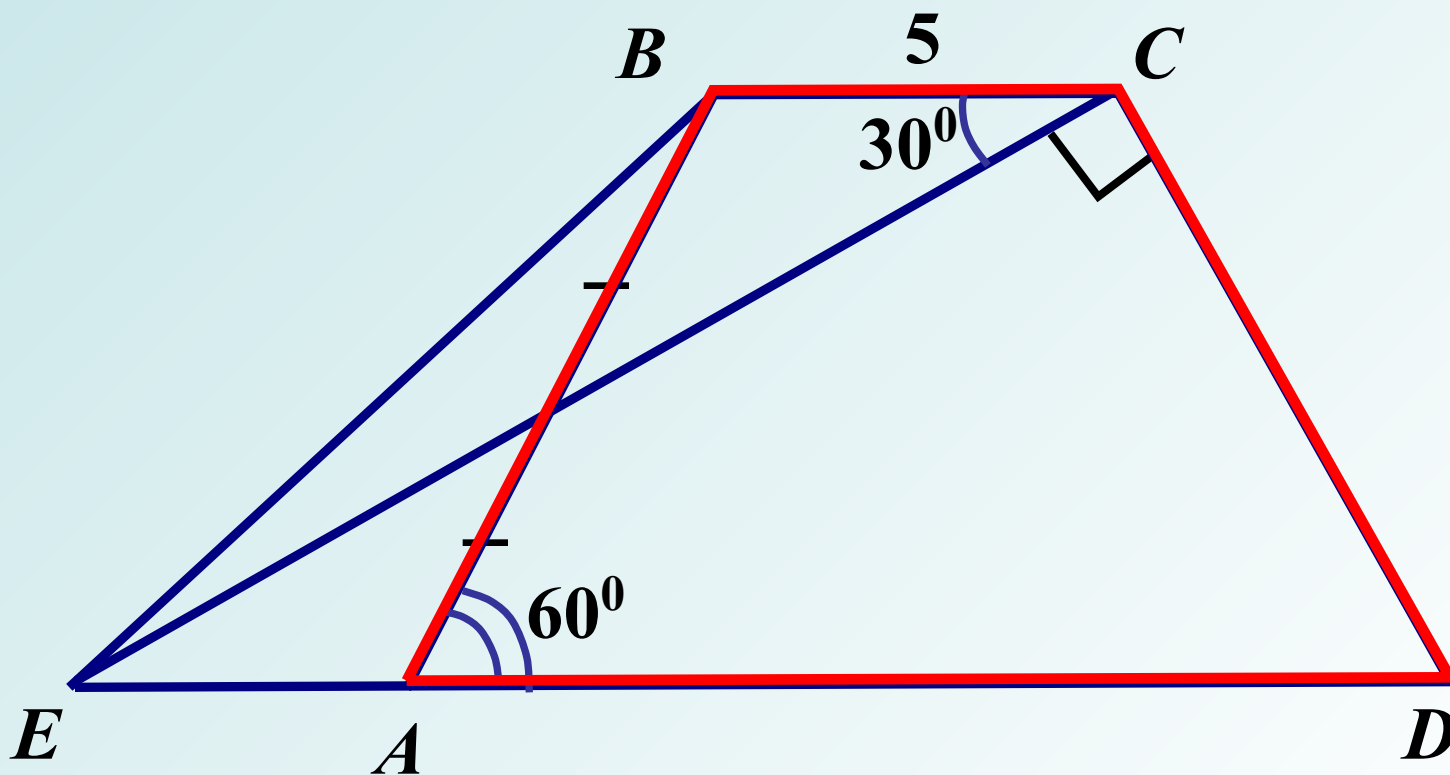

22.

Дано:  $ABCI$  – о́дàìàöèÿ  $AI = 7$

Найти:  $NI$

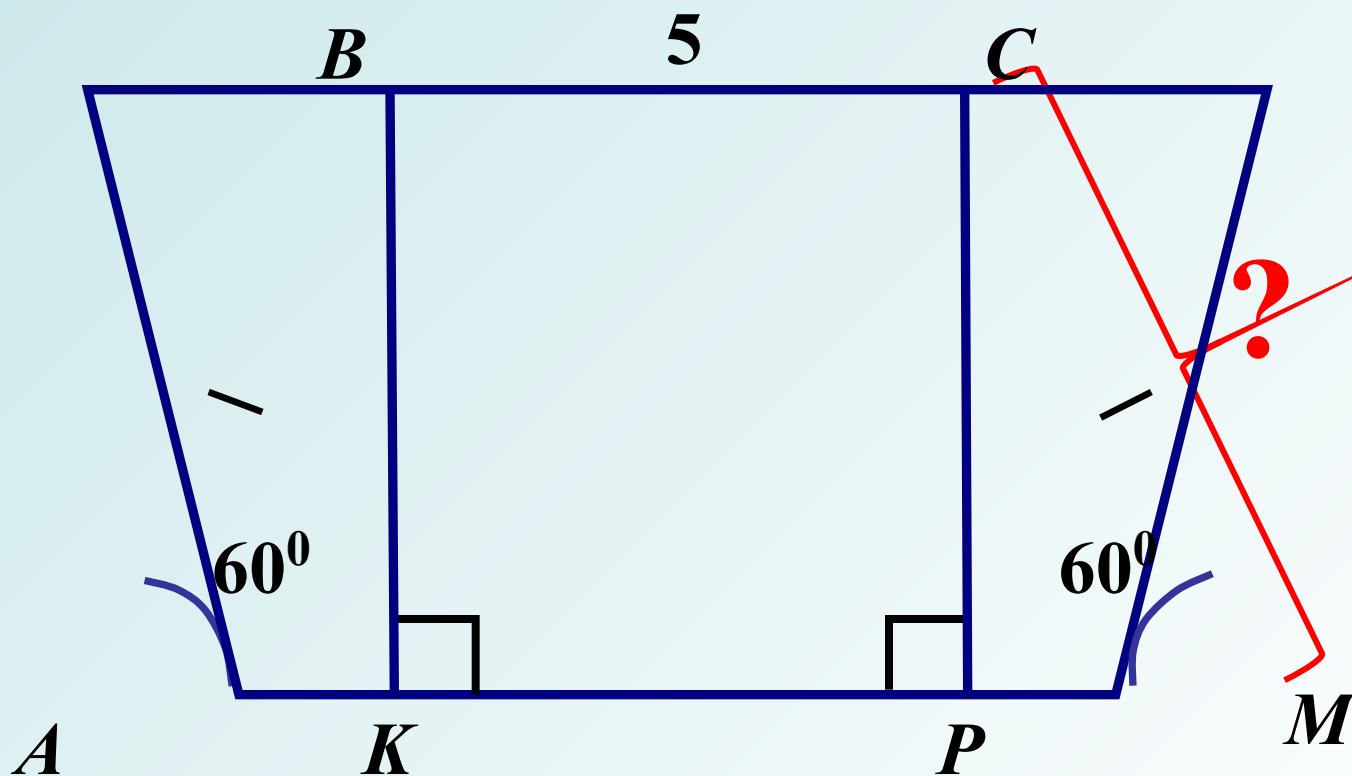



23.

Дано:  $ABCD$  –  $\text{òđàìäöèÿ}$

Найти:

$\angle \tilde{N}$

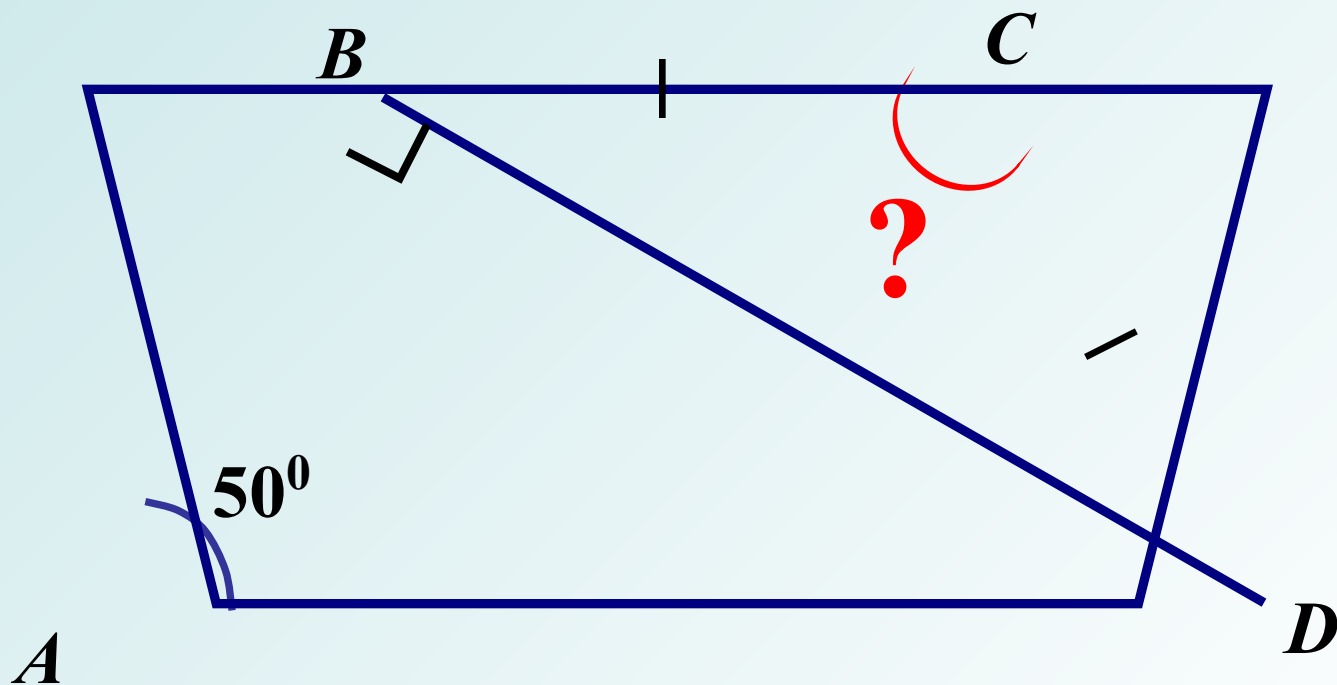

24.

*Дано:*

$$A_1B_1 \parallel A_2B_2 \parallel A_3B_3 \parallel A_4B_4$$
$$AA_1 = A_1A_2 = A_2A_3 = A_3A_4$$
$$AB_4 = 20\tilde{n}i$$

*Найти:*

$$\hat{A}_2\hat{A}_3$$

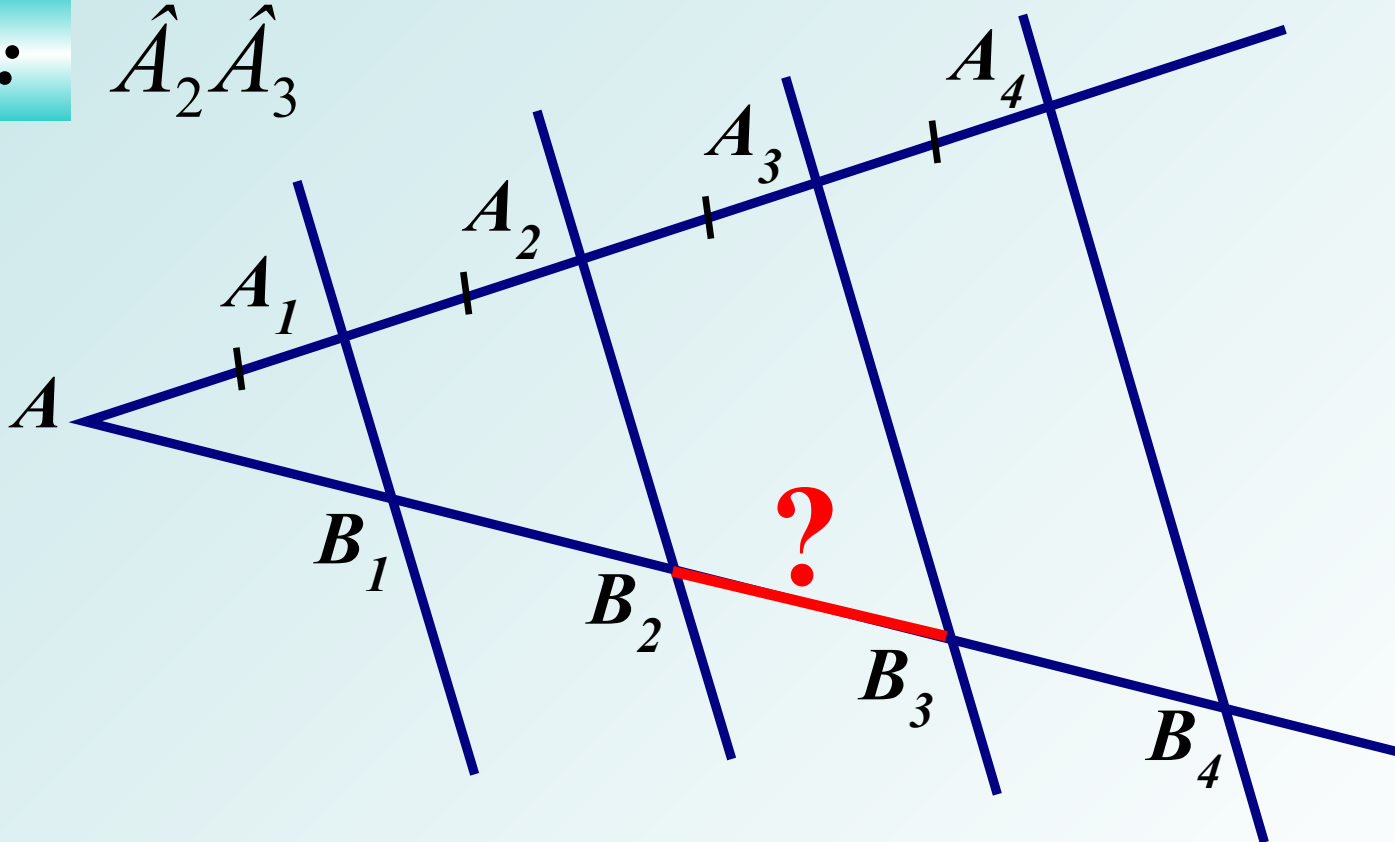

25.

Дано:  $EF \parallel AC$

Найти:

$P_{ABC}$

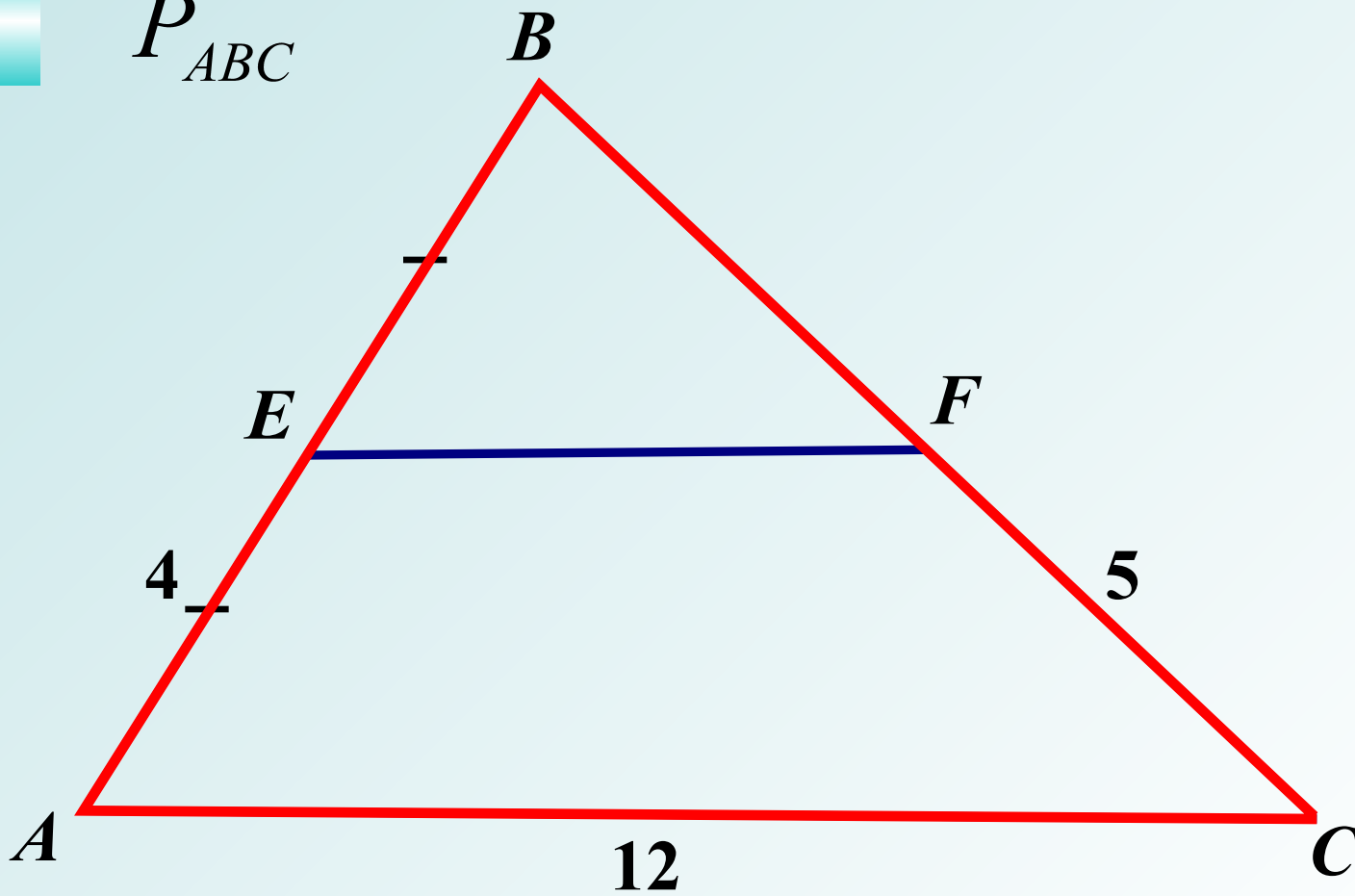

26.

*Дано:*

$МКПВЕПСD$ ,  $AD = 16$

*Найти:*

$AK$

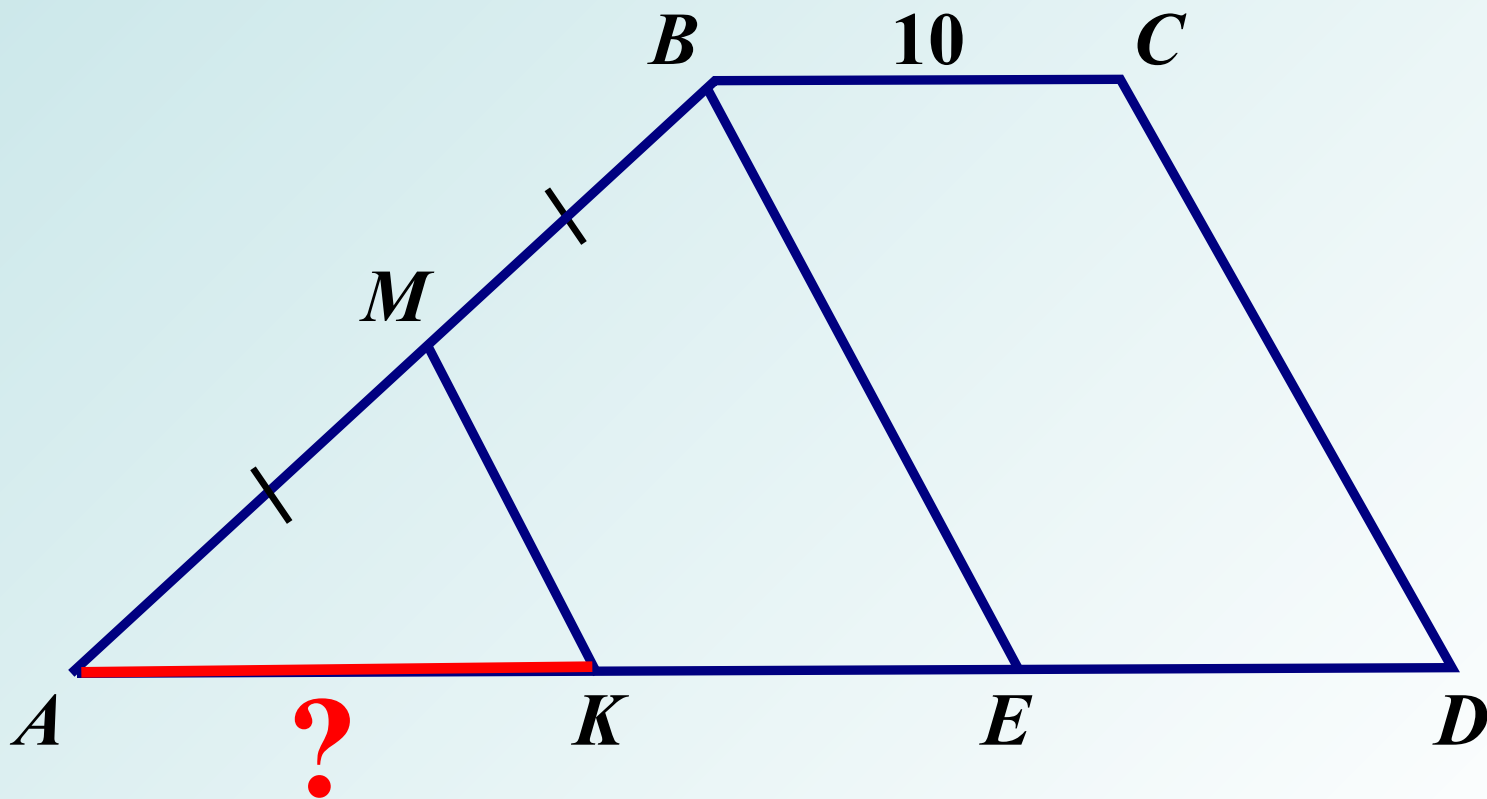



28.

**Дано:**  $ACEK$  –  $\square$   
 $BC = 5 \text{ см}$

**Найти:**  $P_{BDFM}$

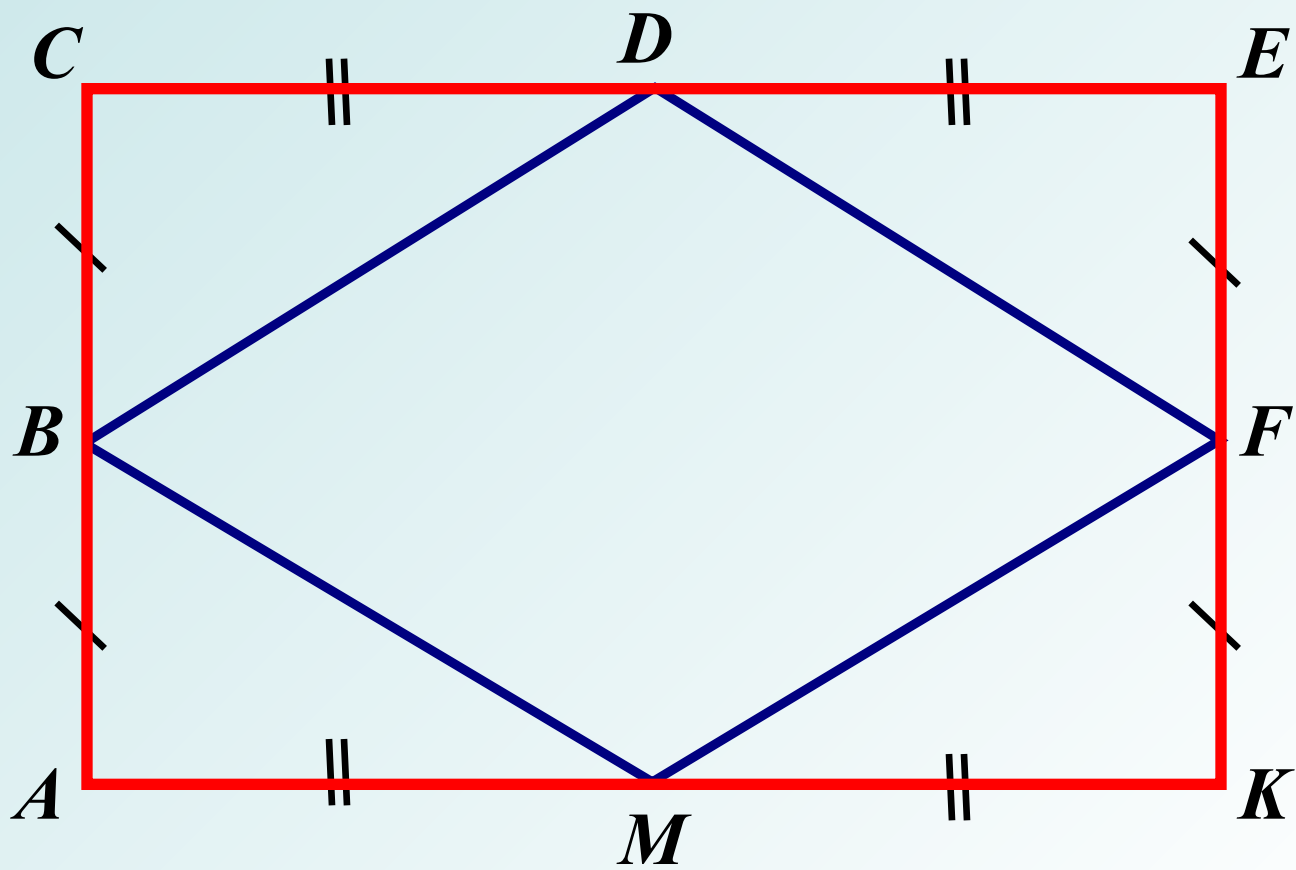

29.

Дано:  $ABCD$  –  $i\delta y\ddot{i}\hat{i}o\tilde{a}\hat{i}\ddot{e}\ddot{u}$   $i\grave{e}\hat{e}$

Найти:

$\angle A\hat{I}B$  ,  $\angle A\hat{I}\tilde{N}$

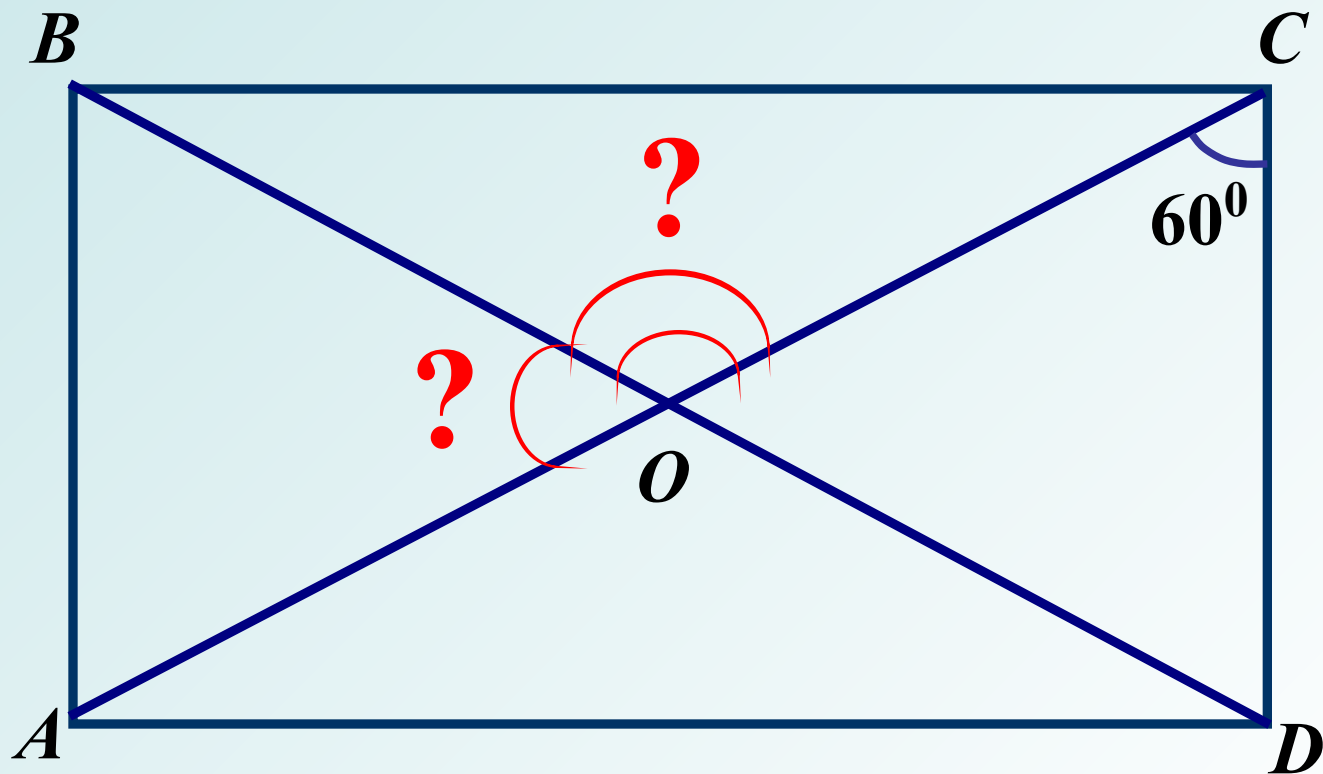

30.

Дано:  $ABCD$  –  $\text{ïðÿìîáñîëü}$   $\text{íèè}$

Найти:  $AN$ ,  $AA$

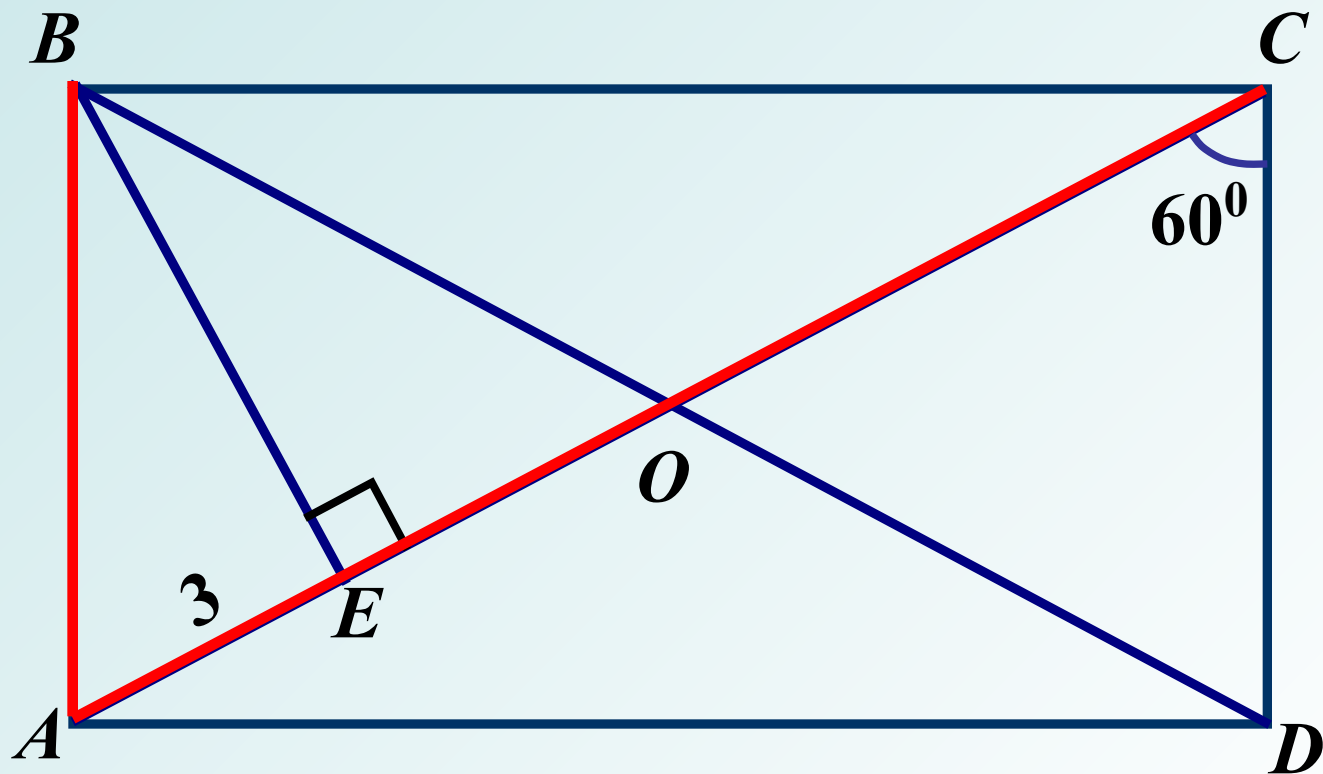



31.

Дано:  $ABCD$  –  $\text{прямоугольник}$   $AC$

Найти:  $AD$

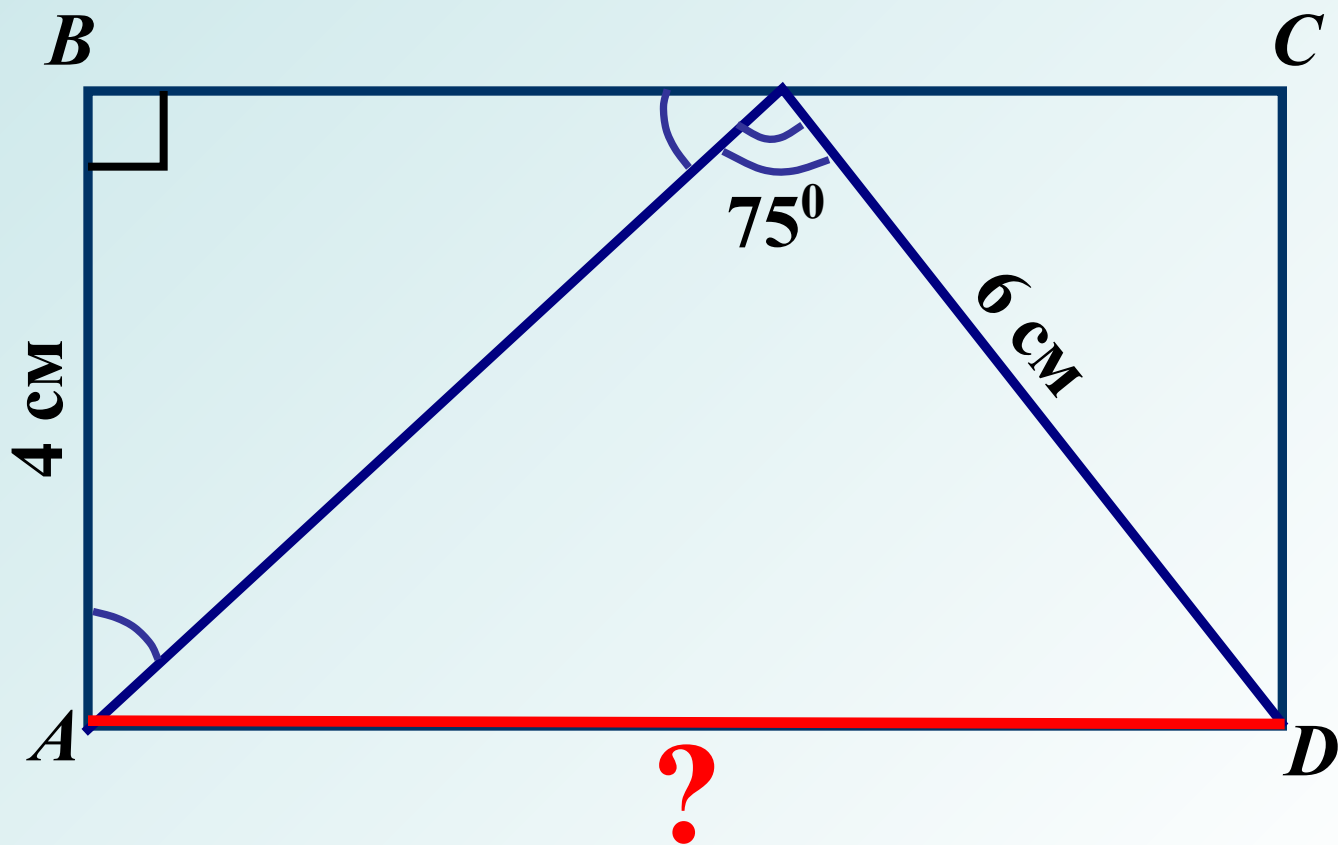

32.

Дано:  $ABCD$  – діїа

Найти:  $MD + DN$

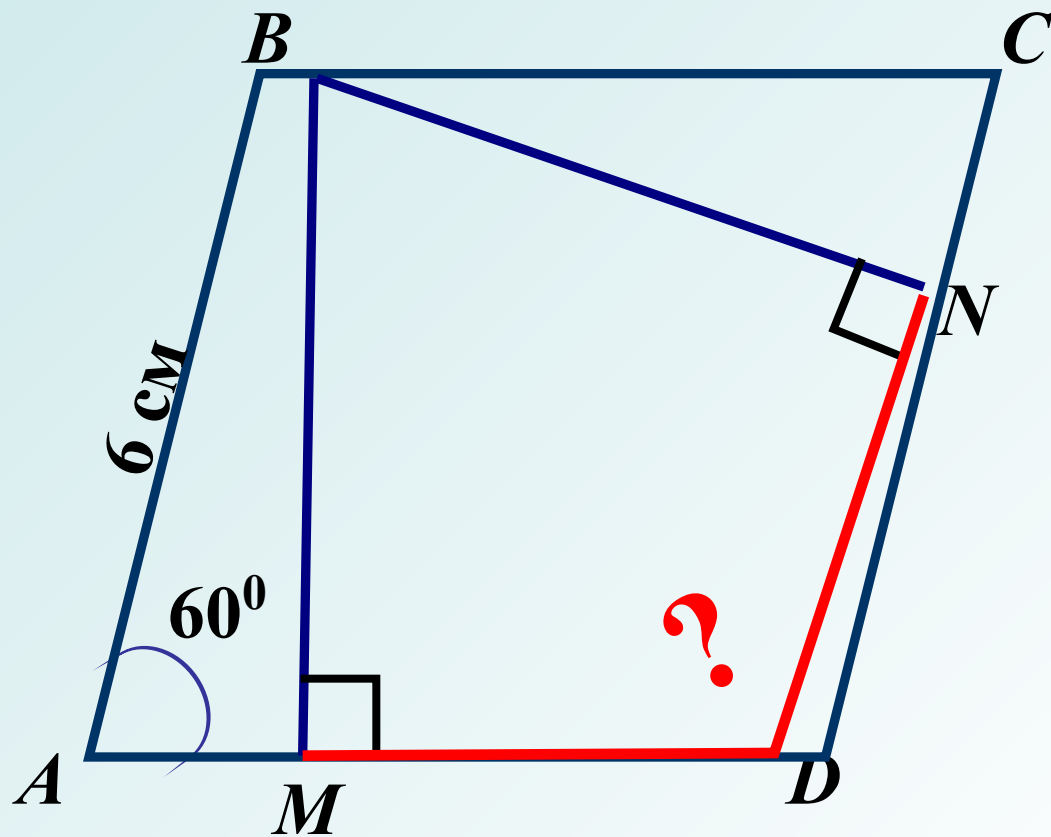

33.

Дано:  $ABCD$  – δία

Найти:  $\angle \tilde{N}B\tilde{A}$

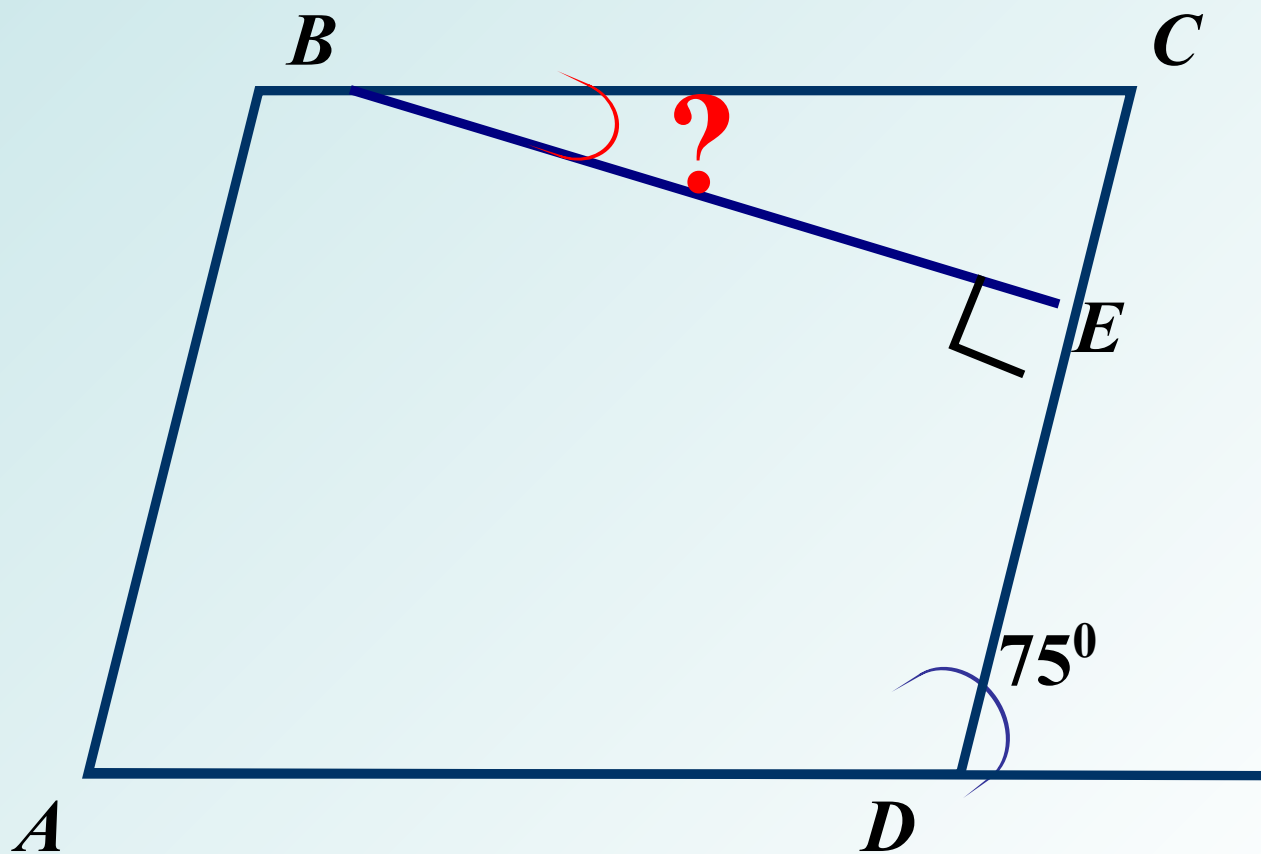

34.

Дано:  $ABCD$  – δία

Найти:  $\angle BAD$

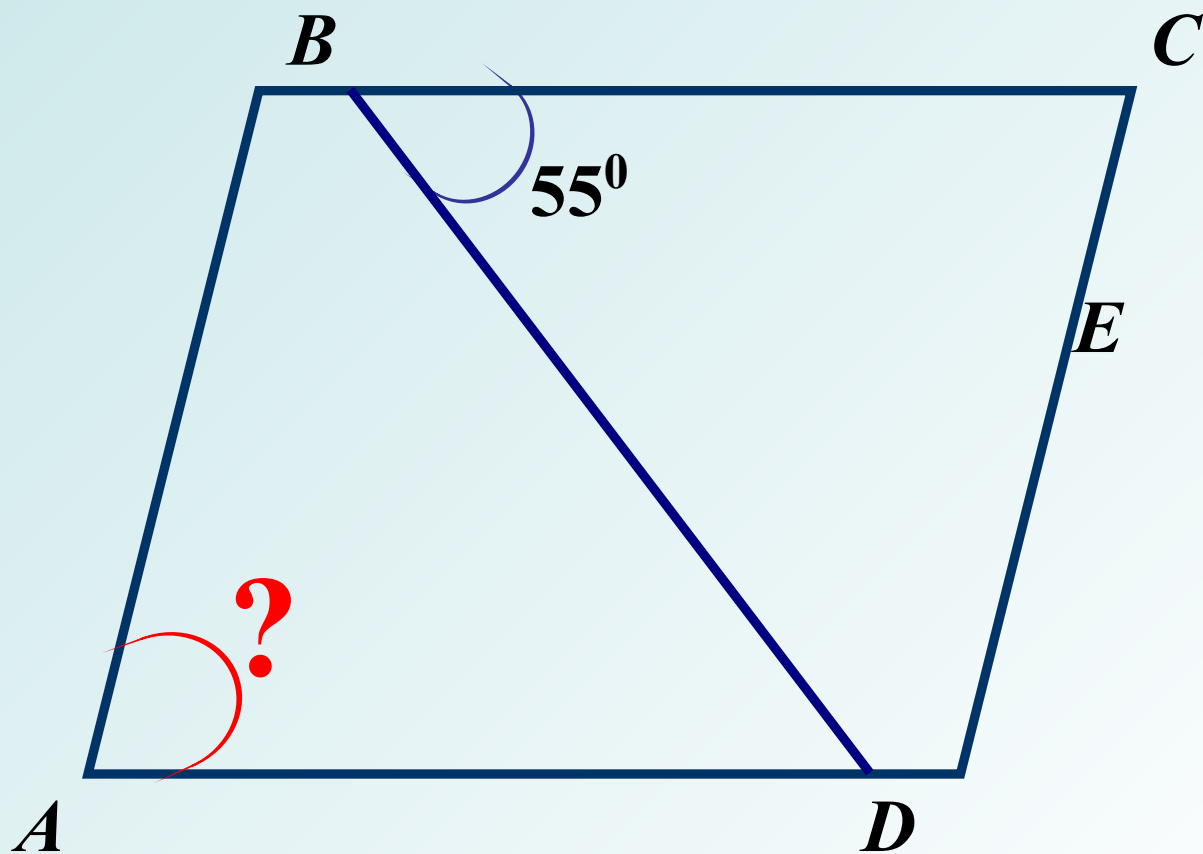

35.

Дано:  $ABCD$  – діа́

Найти:  $\angle ABC$

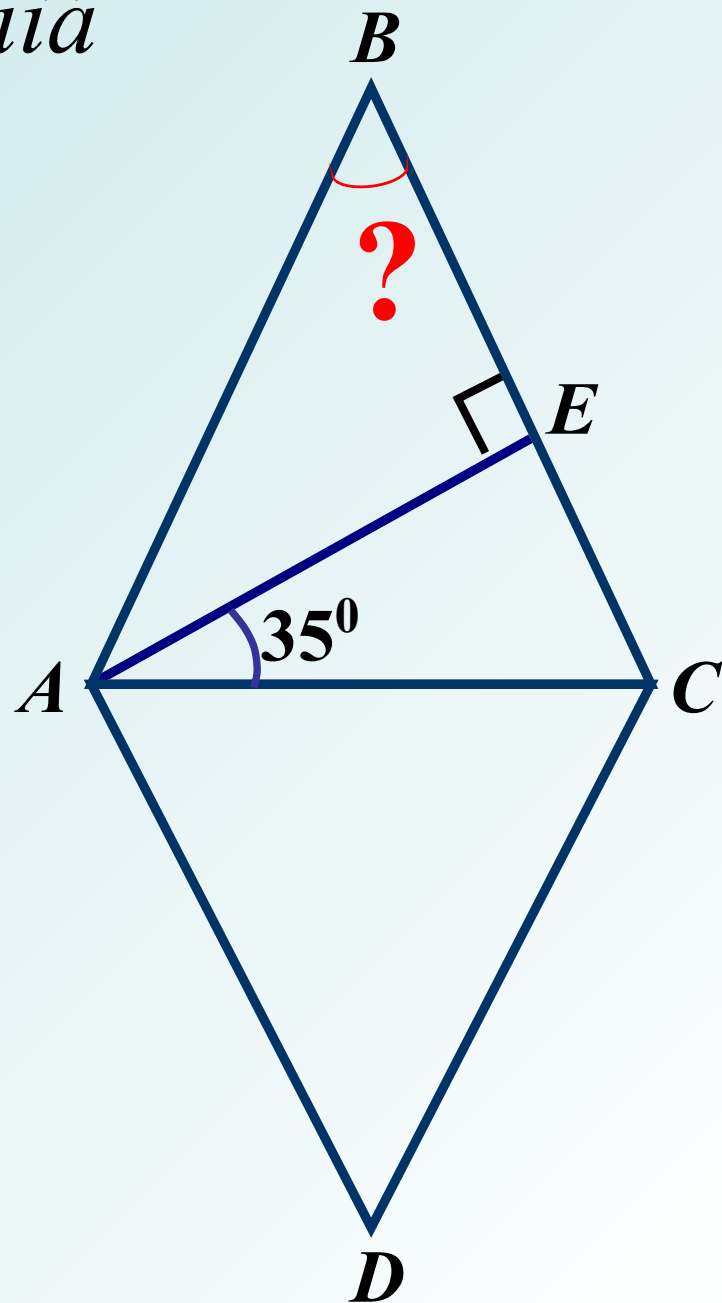

36.

Дано:

$ABCD$  – квадрат

$$DE = 2\sqrt{3}, AE = \sqrt{3}$$

Найти:

$P_{ABCD}$

