

*Решение задач  
на готовых чертежах.*

*Прямоугольный  
треугольник.*

*Геометрия.  
8 класс.*

*Каратанова Марина Николаевна  
МОУ СОШ №256 г.Фокино*



**1**

**2**

**3**

**4**

**5**

**6**

**7**

**8**

**9**

**10**

**11**

**12**

**13**

**14**

**15**

**16**

**17**

**18**

**19**

**20**

**21**

**22**

**23**

**24**

**25**

**26**

**27**

**28**

**29**

**30**

1.

*Дано:*  $\triangle ABC$

*Найти:*

$\sin B$ ,  $\cos B$ ,  $\operatorname{tg} B$

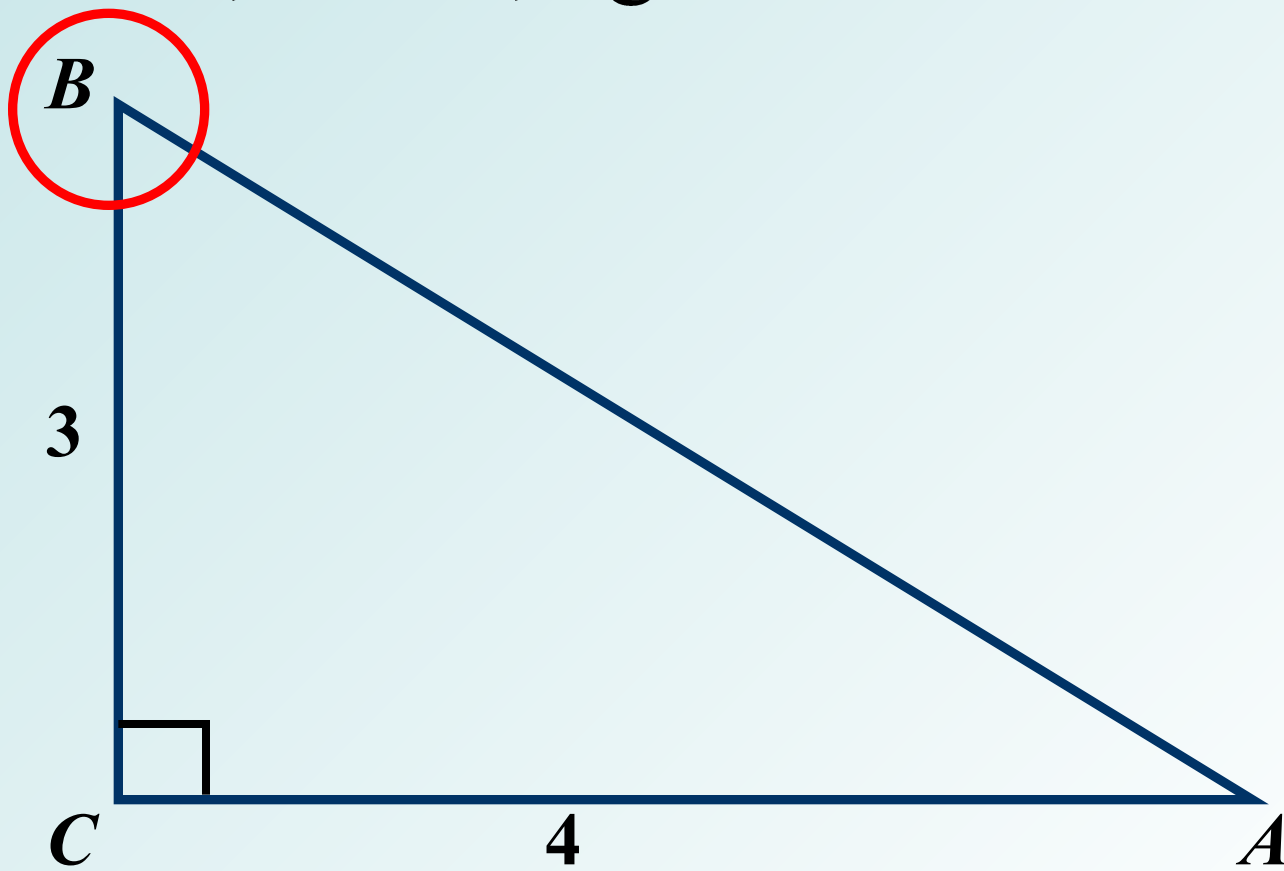

2.

*Дано:*

$\triangle ABC$ ,  $\hat{A} = 8$

*Найти:*

$S_{ABC}$

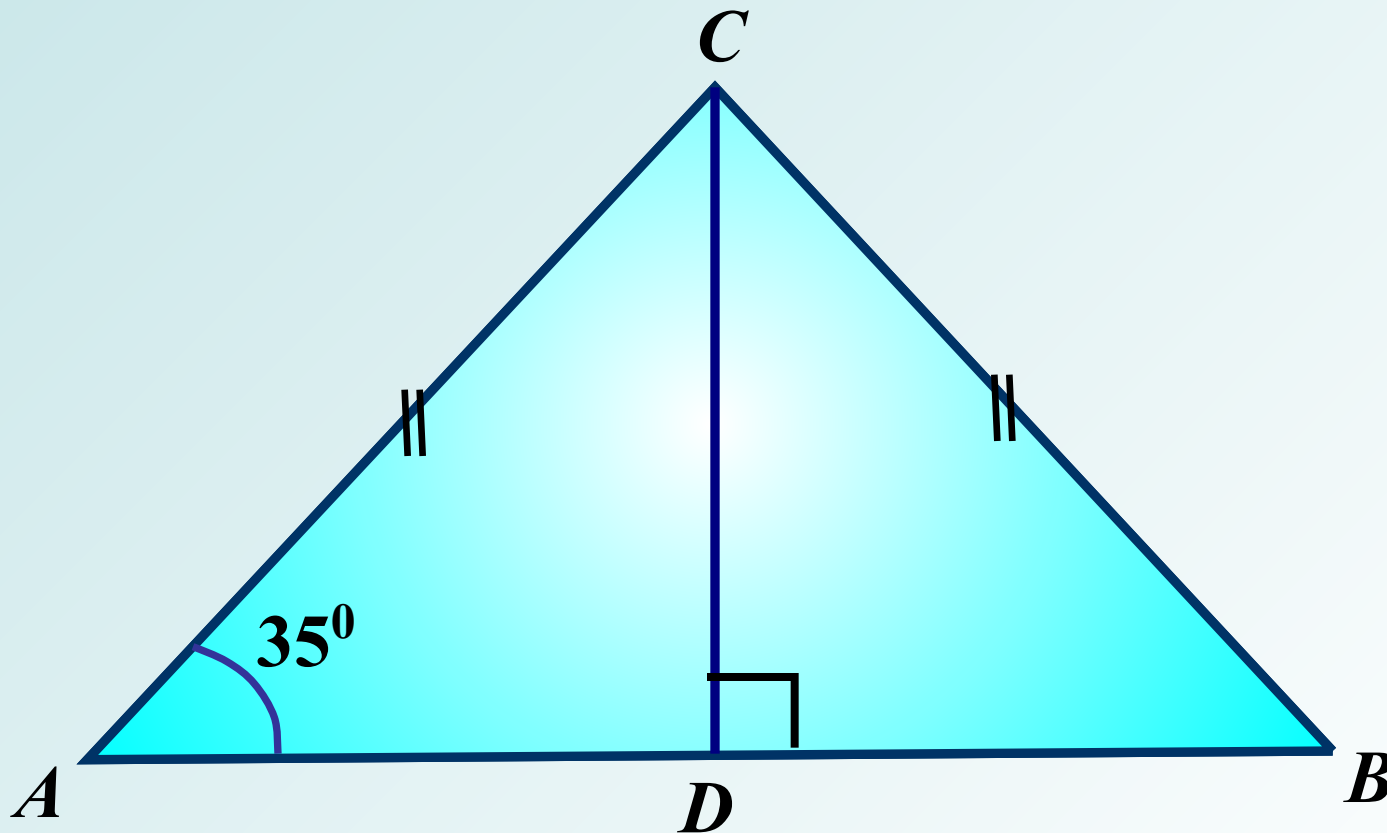

3.

**Дано:**  $ABCD$  –  $\text{прямоугольник}$   $AC \perp BD$

**Найти:**  $\angle N$ ,  $\angle D$

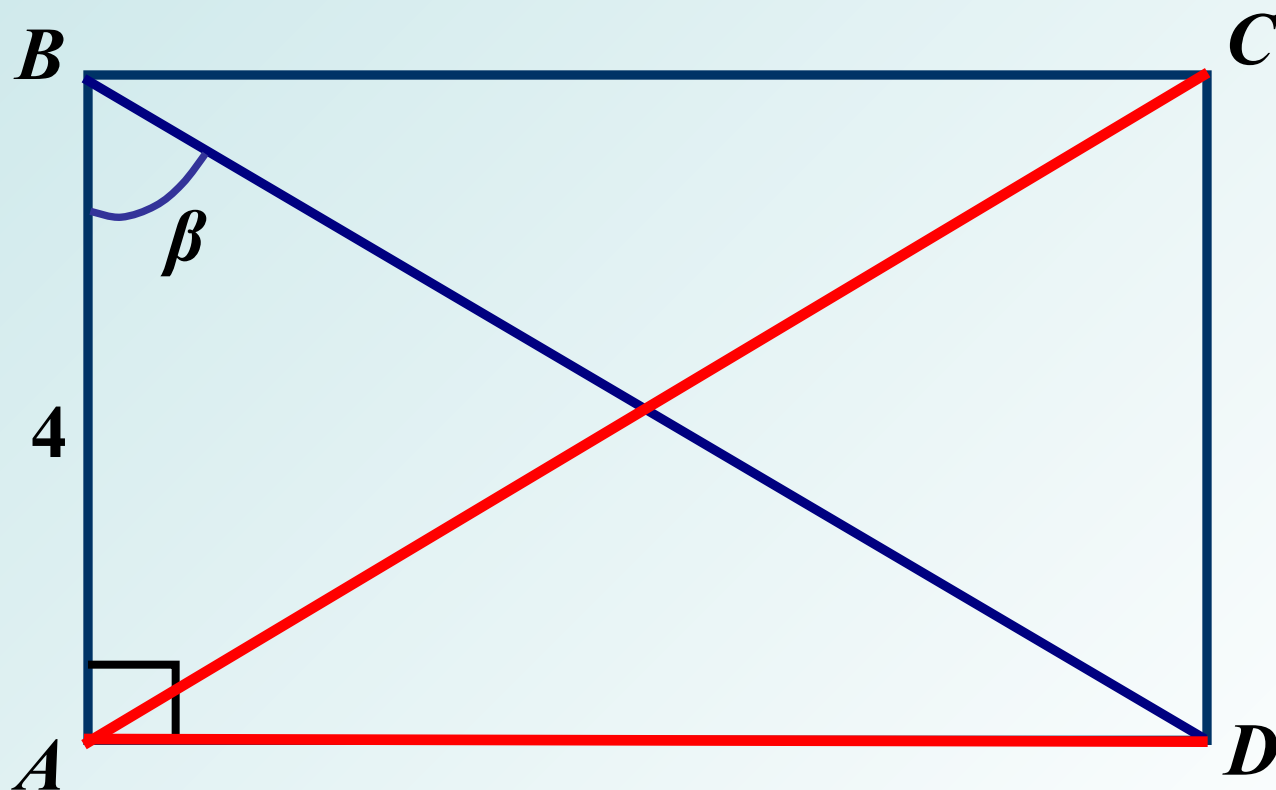

4.

**Дано:**  $ABCD$  – трапеция

**Найти:**  $AD$ ,  $CD$ ,  $S_{ABCD}$

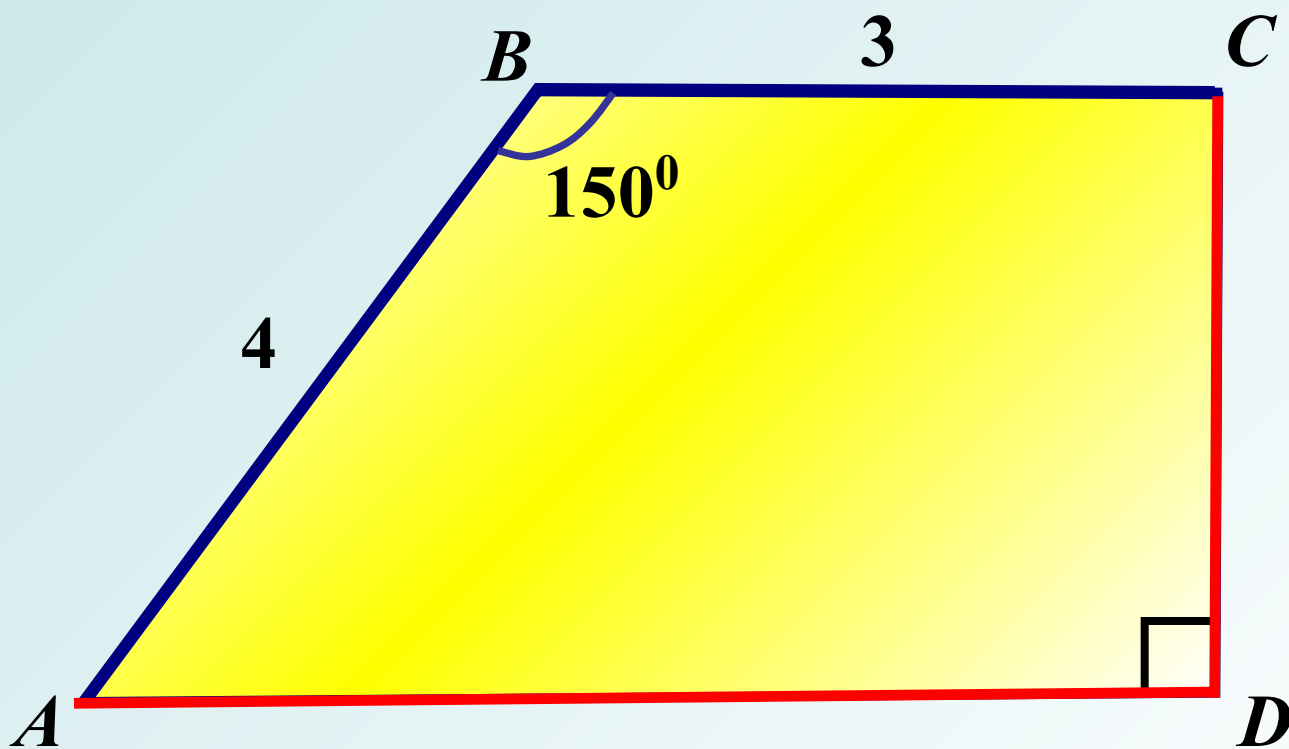

5.

**Дано:**  $ABCD$  – о́дàíàóöèÿ

**Найти:**

$\angle A$ ,  $\angle A$

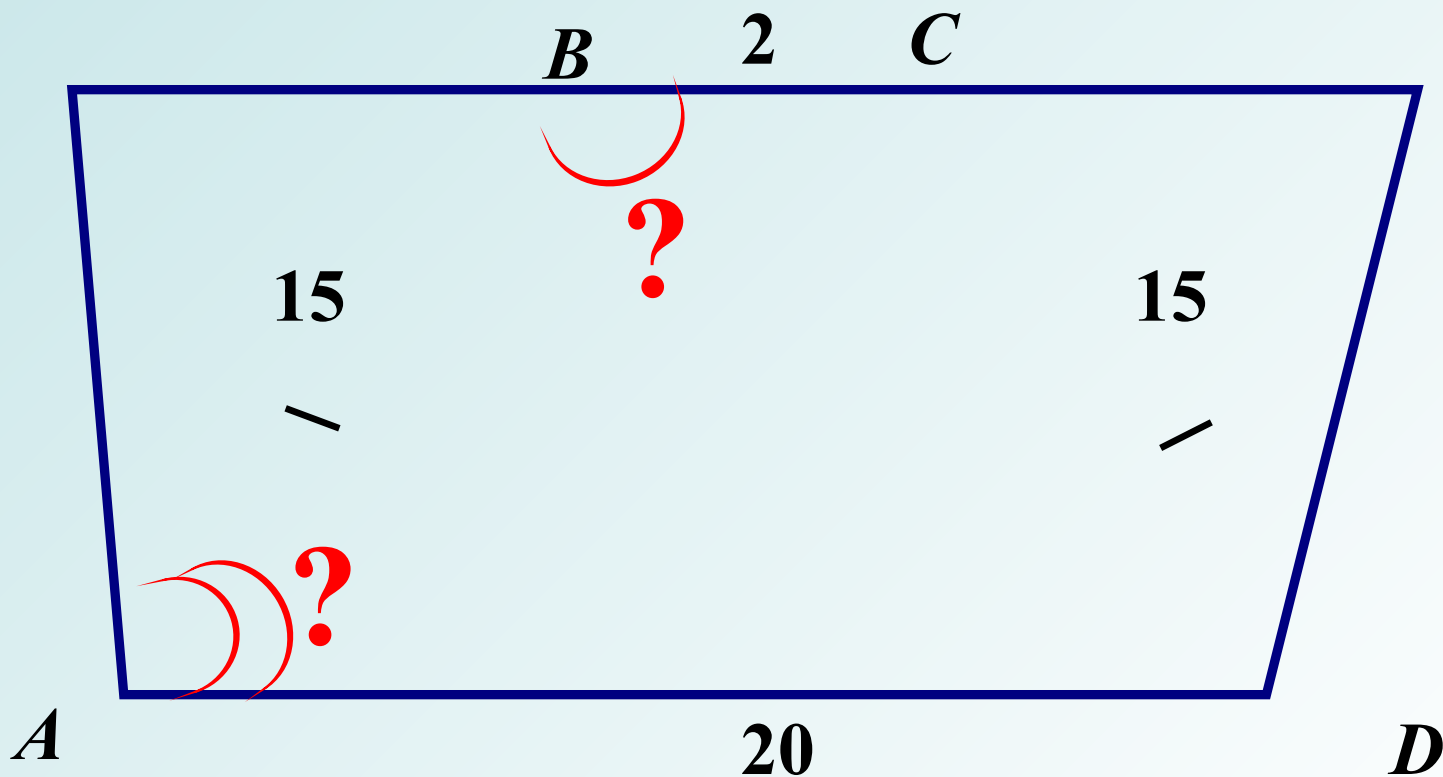

6.

Дано:  $\triangle ABC$

Найти:

$AN$

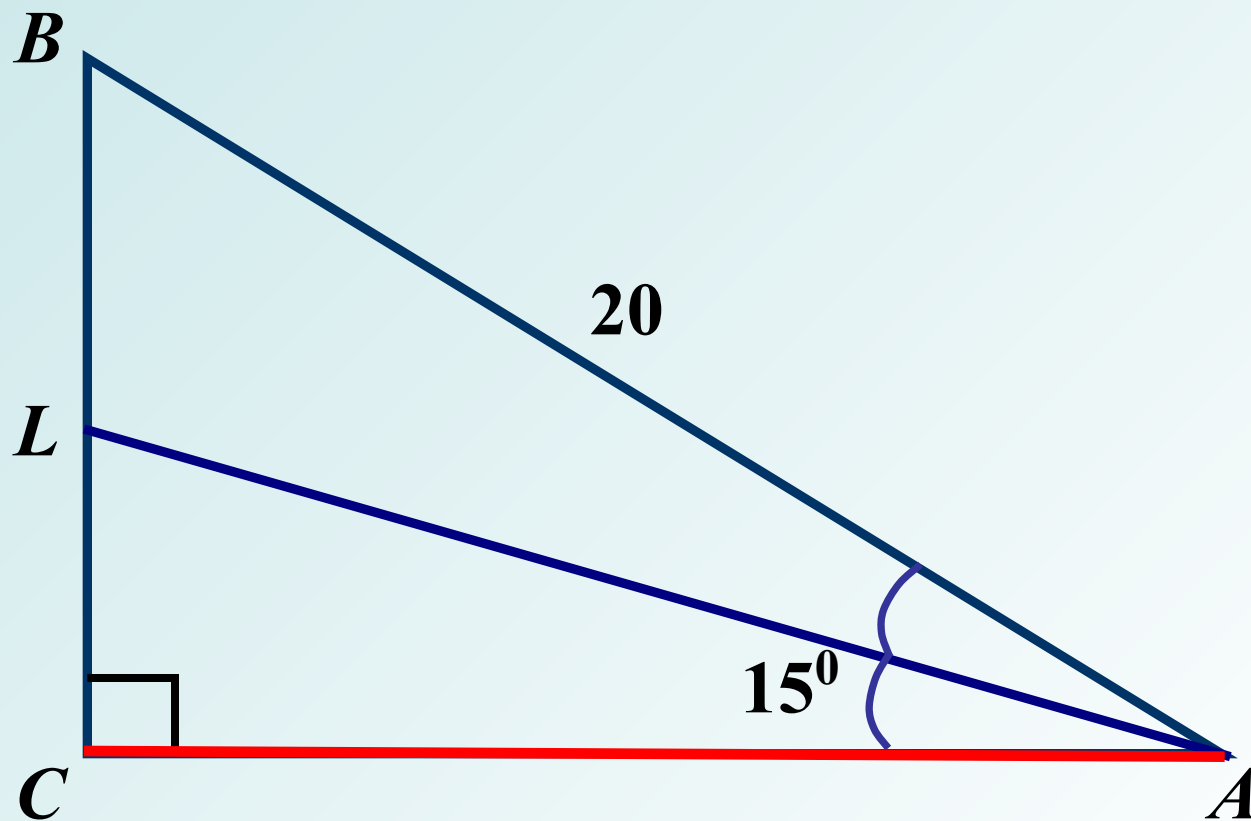



7.

Дано:  $\hat{A}\hat{B}\hat{N}\hat{D}$  – о́дàïàóëèÿ

Найти:

$$S_{\hat{A}\hat{B}\hat{N}\hat{D}}$$

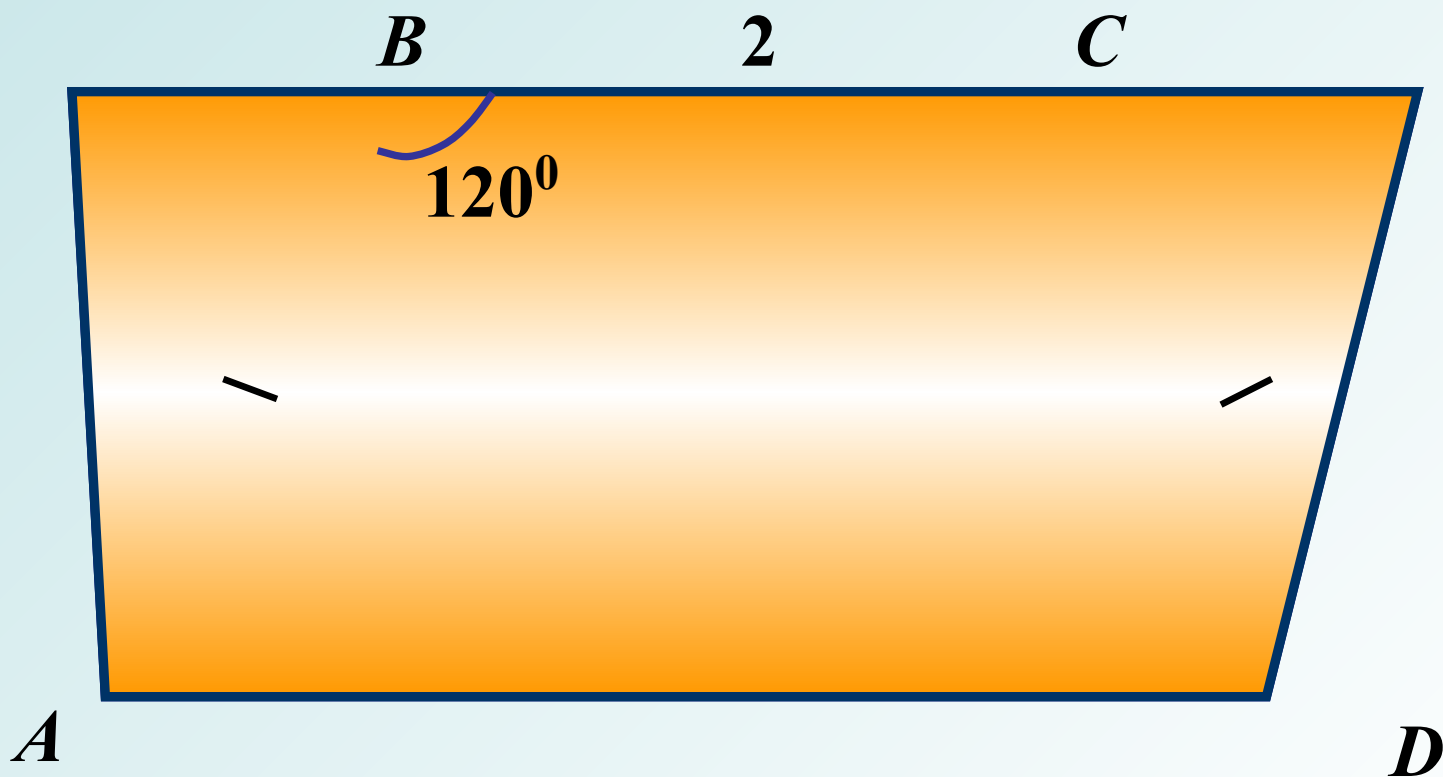

8.

Дано:  $\triangle A\hat{A}\tilde{N}$

Найти:  $AD, AC$

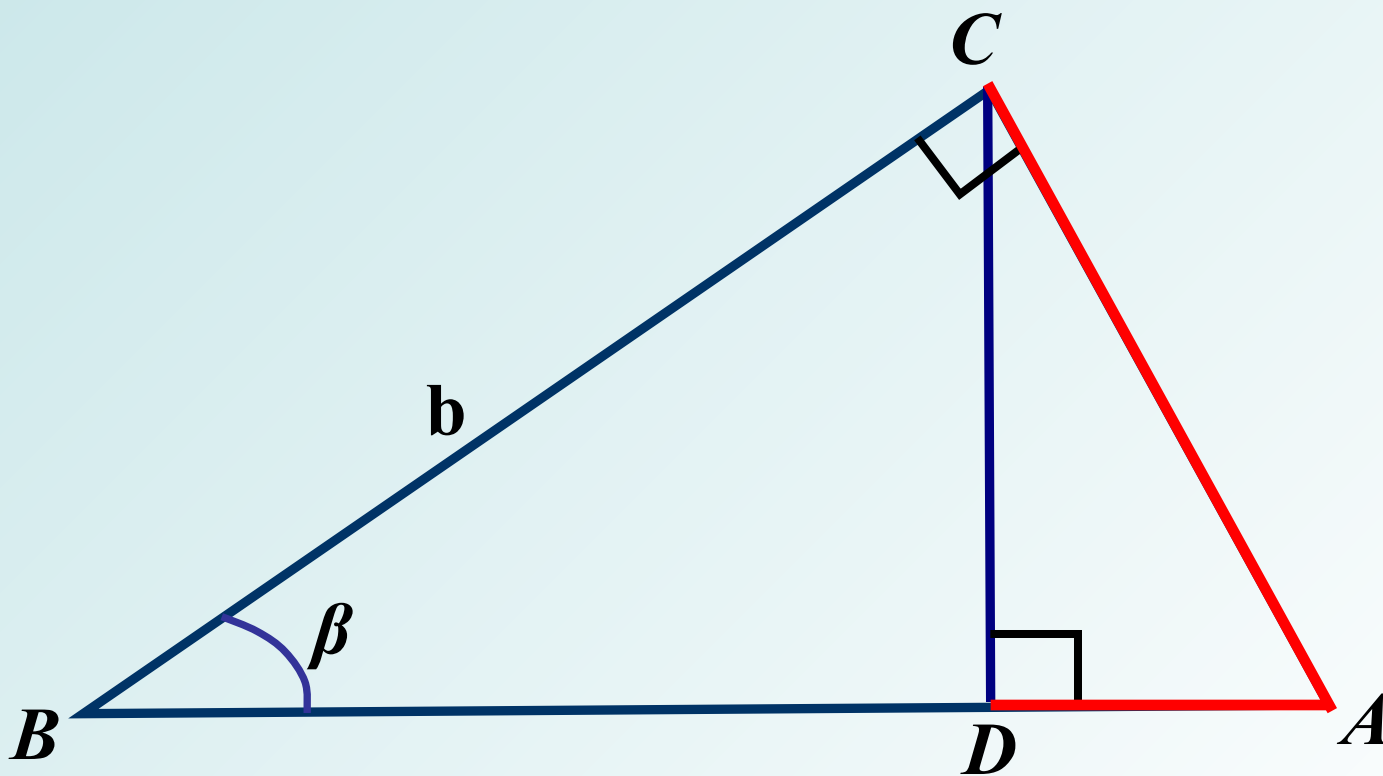

9.

*Дано:*

$AB\tilde{N}D$  – о́дàìàöèÿ

*Найти:*

$AD, S_{ABCD}$

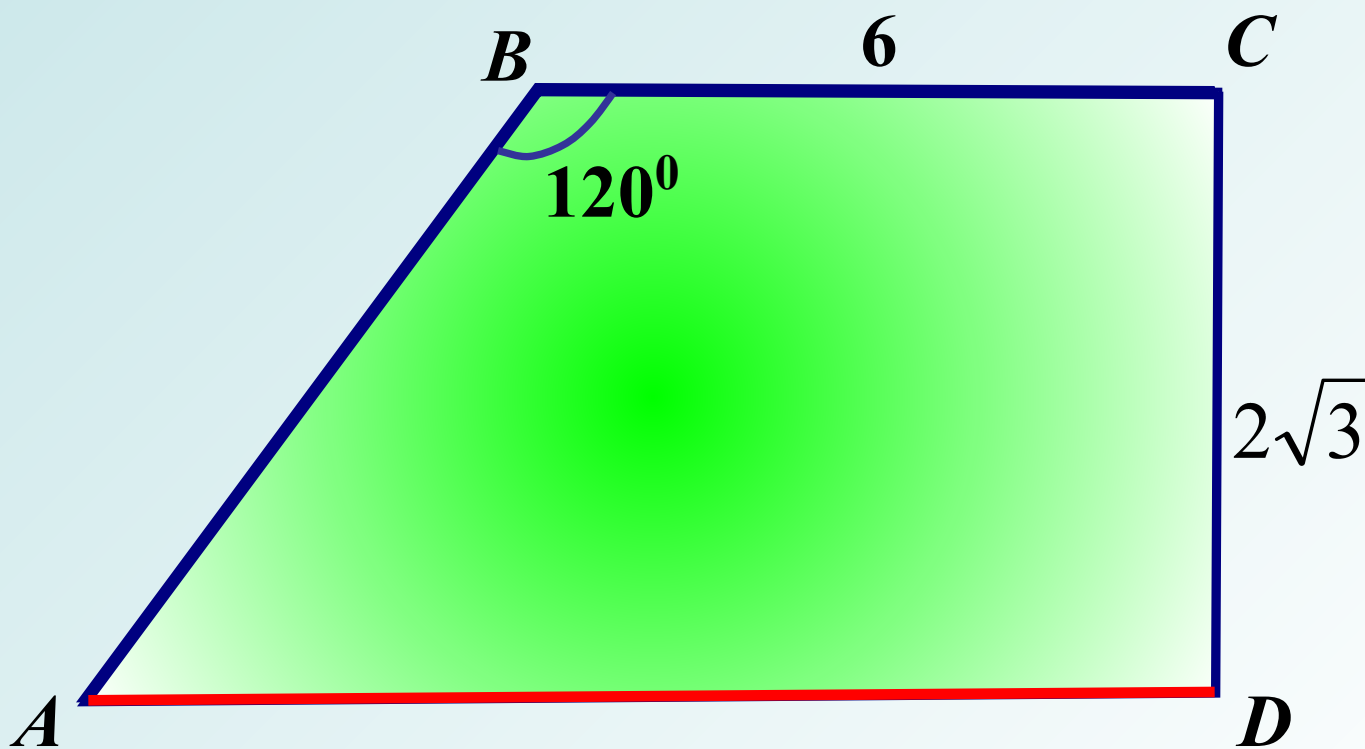

10.

*Дано:*

$$\Delta ABC, \cos B = \frac{1}{3}, \hat{A} = 4$$

*Найти:*

$\hat{E}$

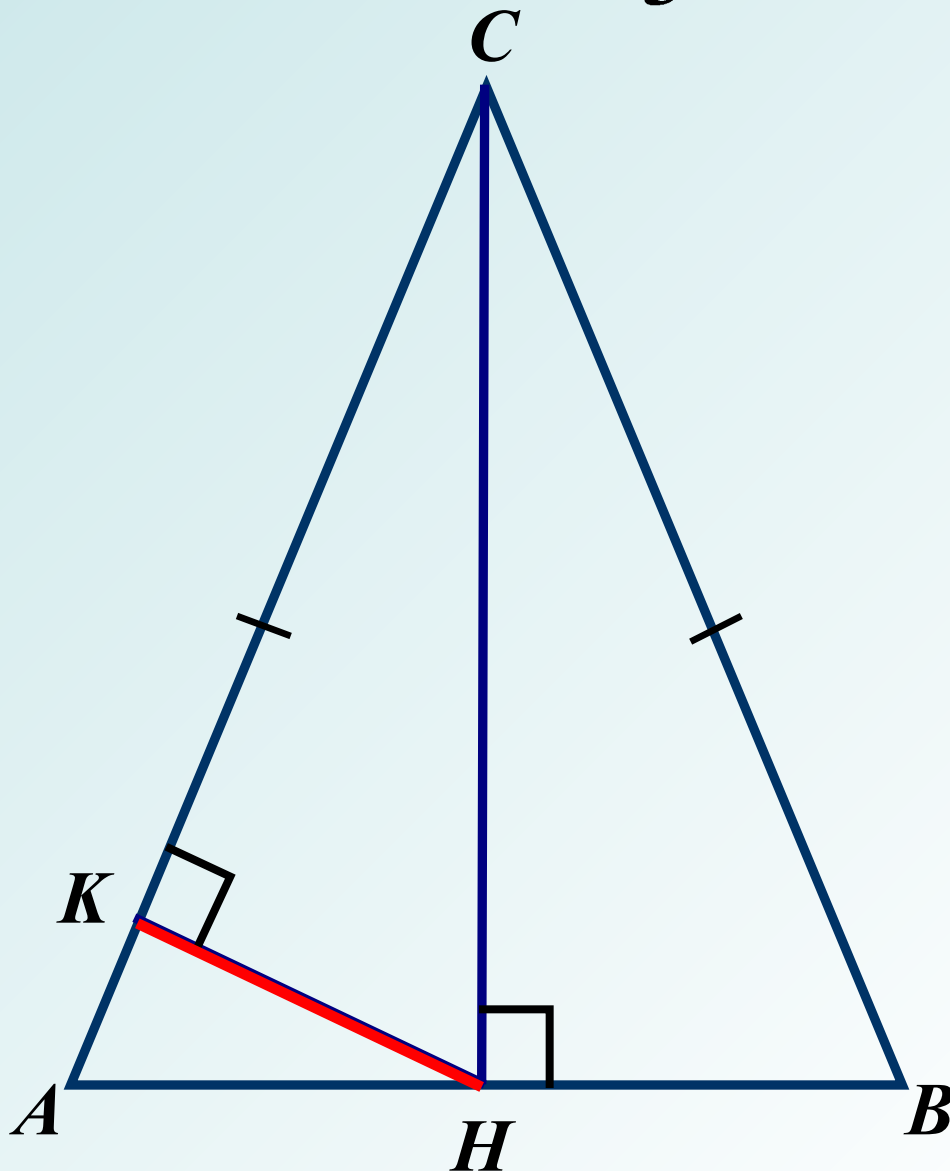

11.

Дано:  $\triangle A\hat{A}C$

Найти:  $BD$

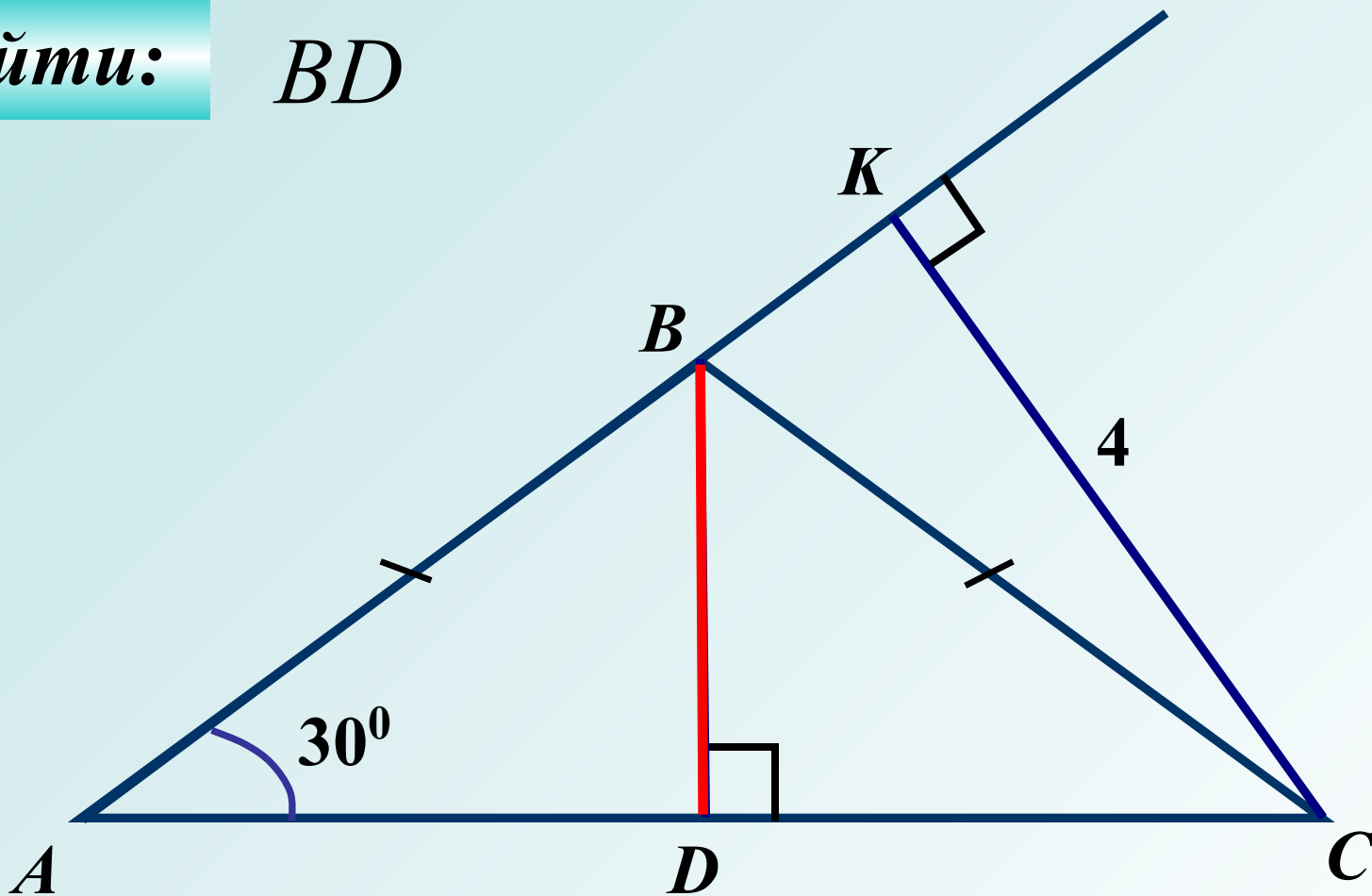

12.

Дано:

$ABCD$  –  $\triangle$ ,  $\angle B = 90^\circ$ ,  $\angle C = 90^\circ$

Найти:

$AD$

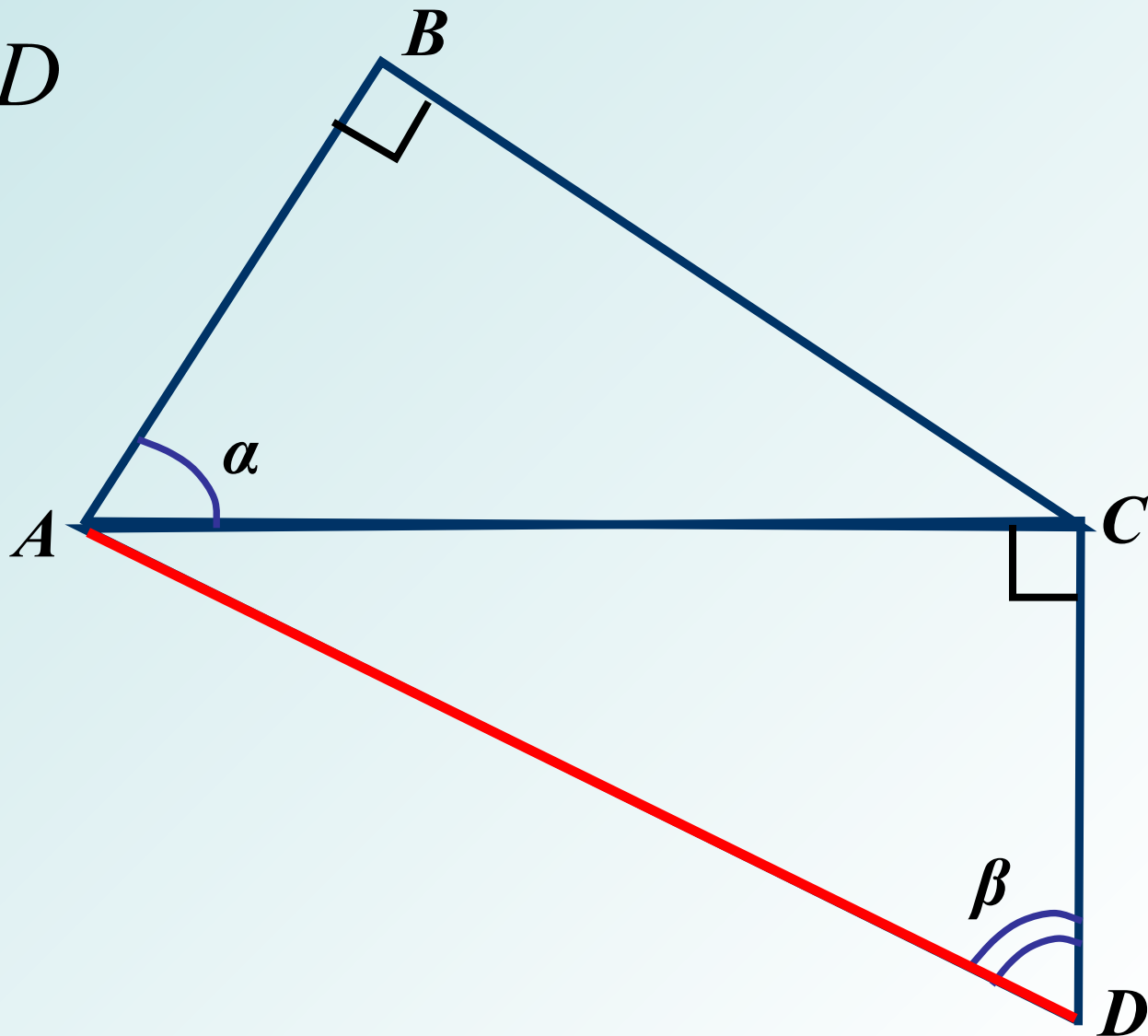

13.

Дано:  $\triangle ABC$

Найти:  $BC$ ,  $AC$ ,  $S_{\triangle ABC}$

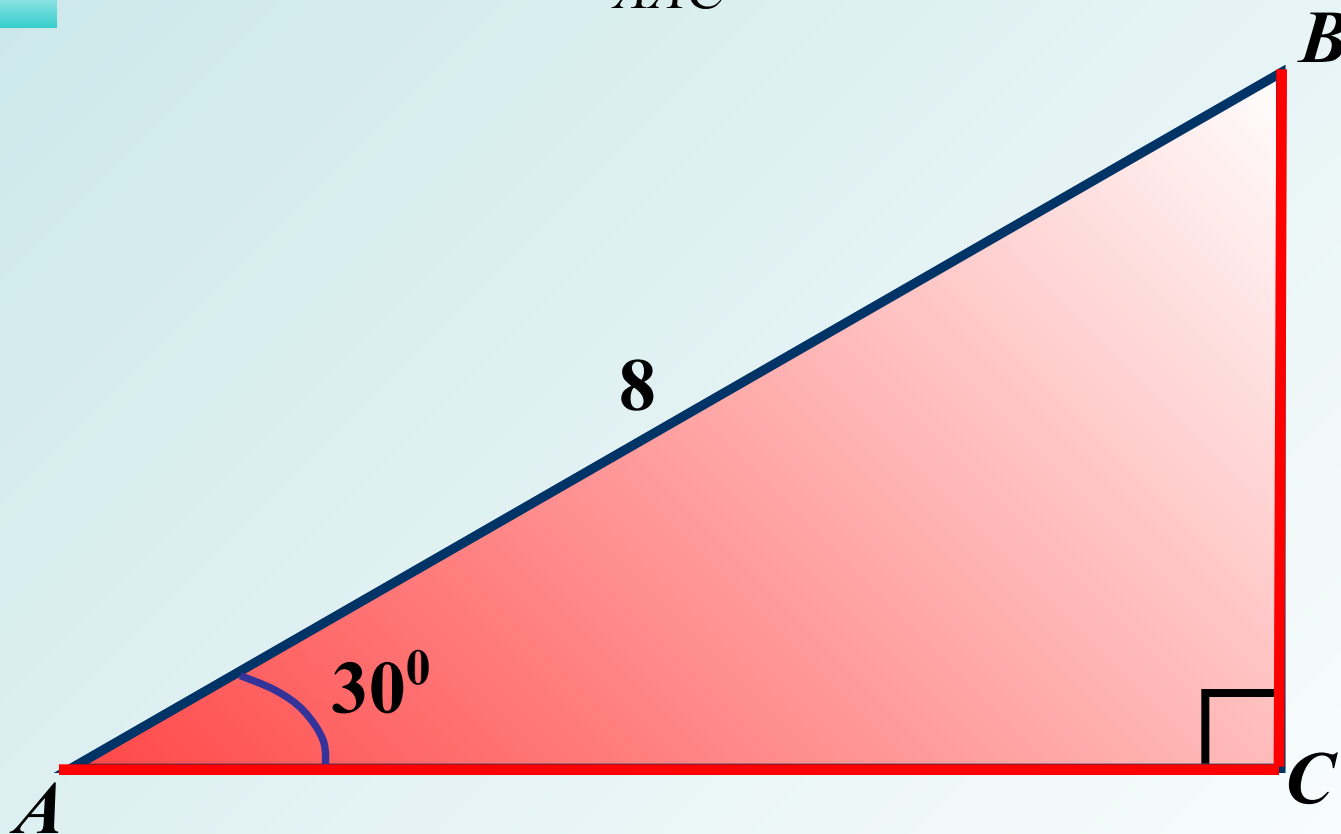

14.

*Дано:*  $\triangle MKN$

*Найти:*  $MK, MN$

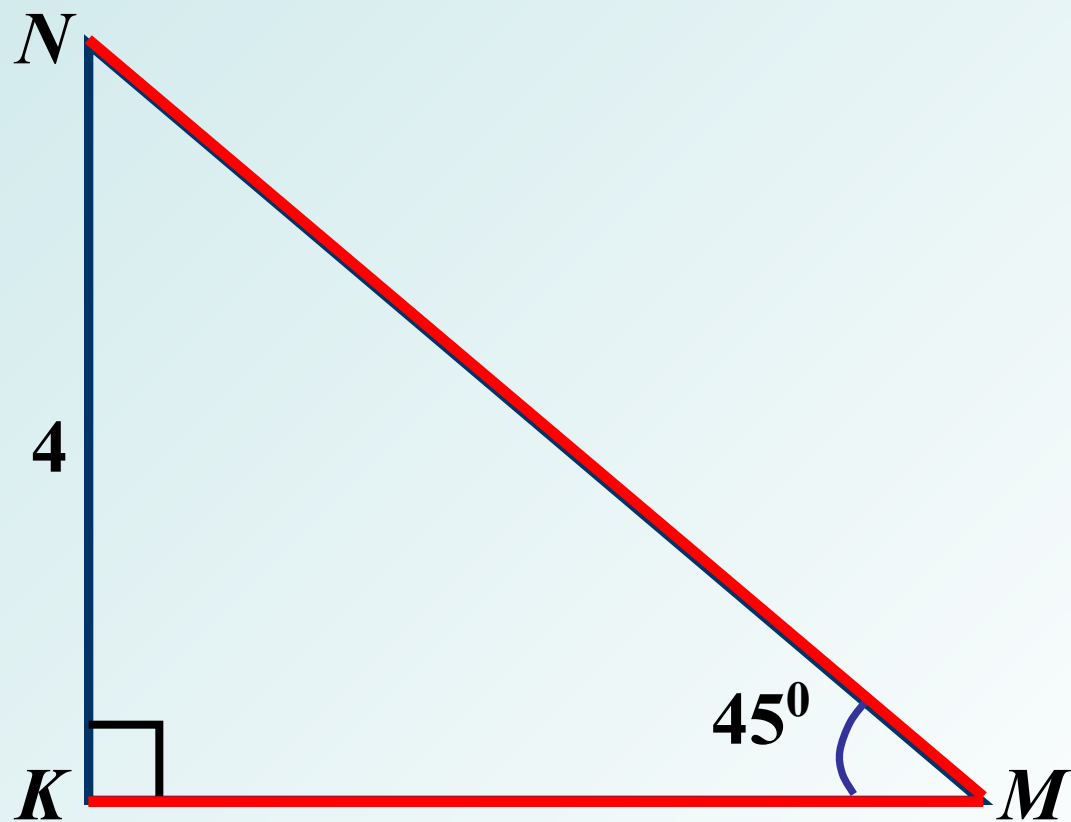



15.

**Дано:**  $\triangle MPE$ ,  $ME = b$ ,  $\angle MPE = \beta$

**Найти:**  $MP$ ,  $PA$

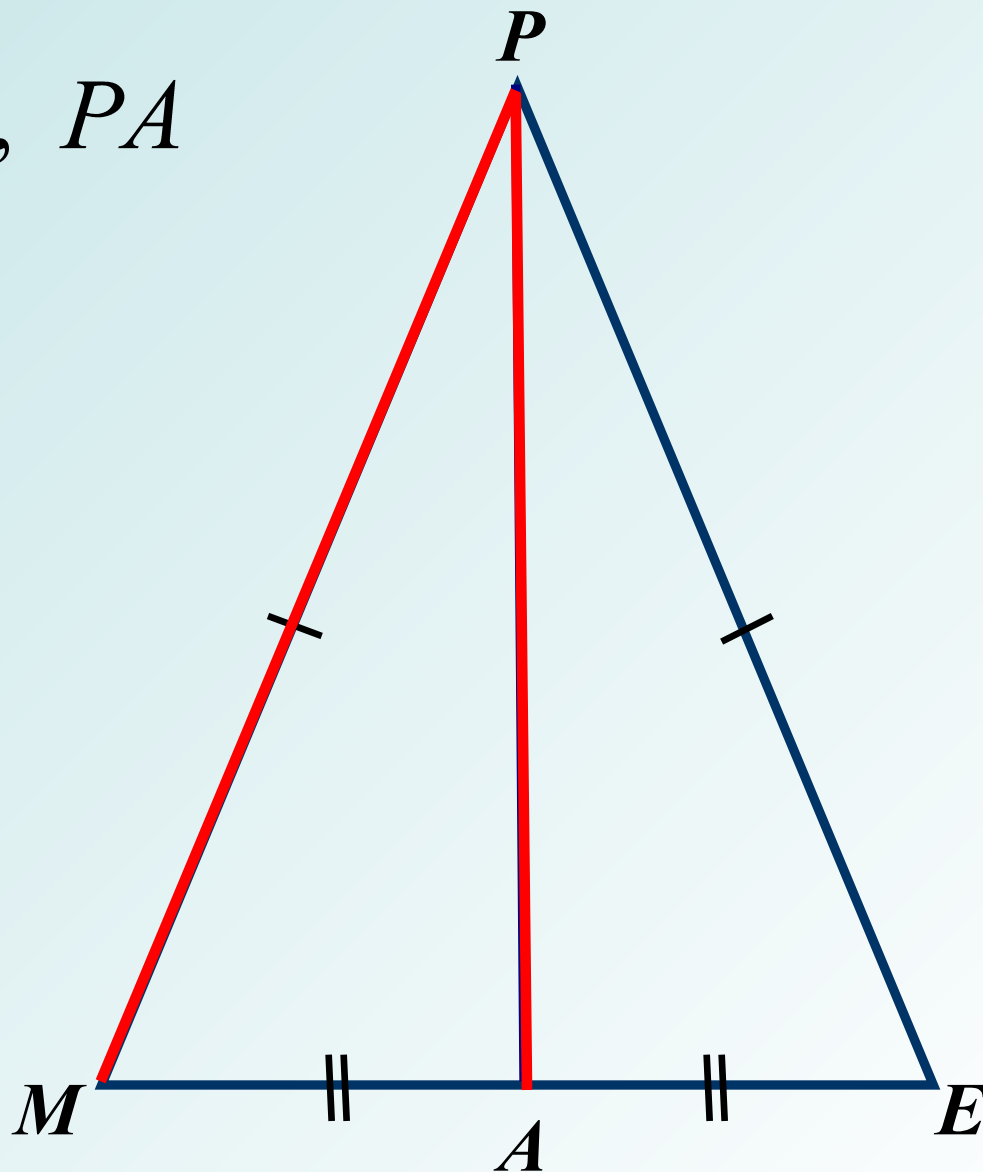

16.

**Дано:**

$\triangle ABC$ ,  $\angle ABC = 60^\circ$

$BF$  – медиана

**Найти:**  $\hat{A}F$

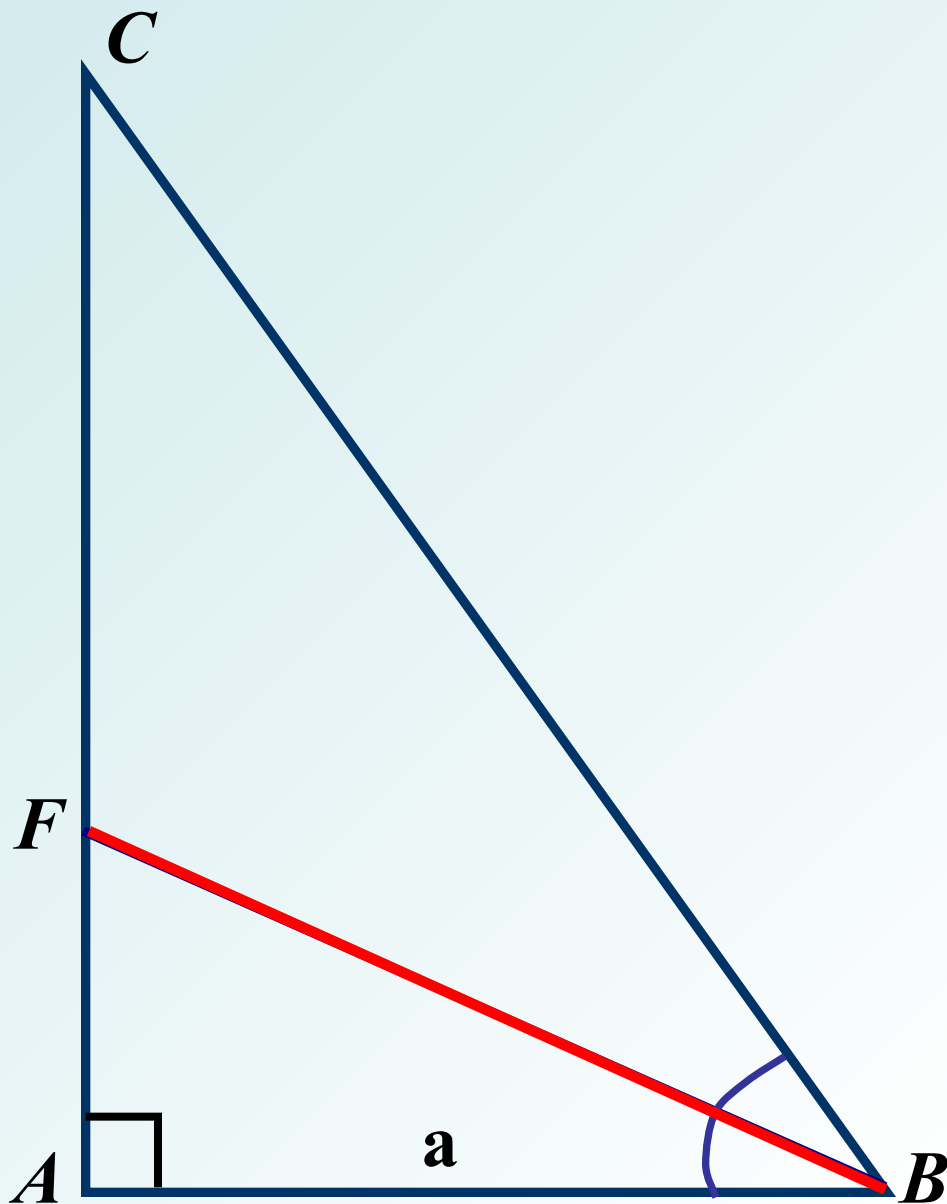

17.

**Дано:**  $ABCD$  –  $\text{прямоугольник}$   $\angle A = 90^\circ$

**Найти:**  $CD$ ,  $AC$ ,  $S_{ABCD}$

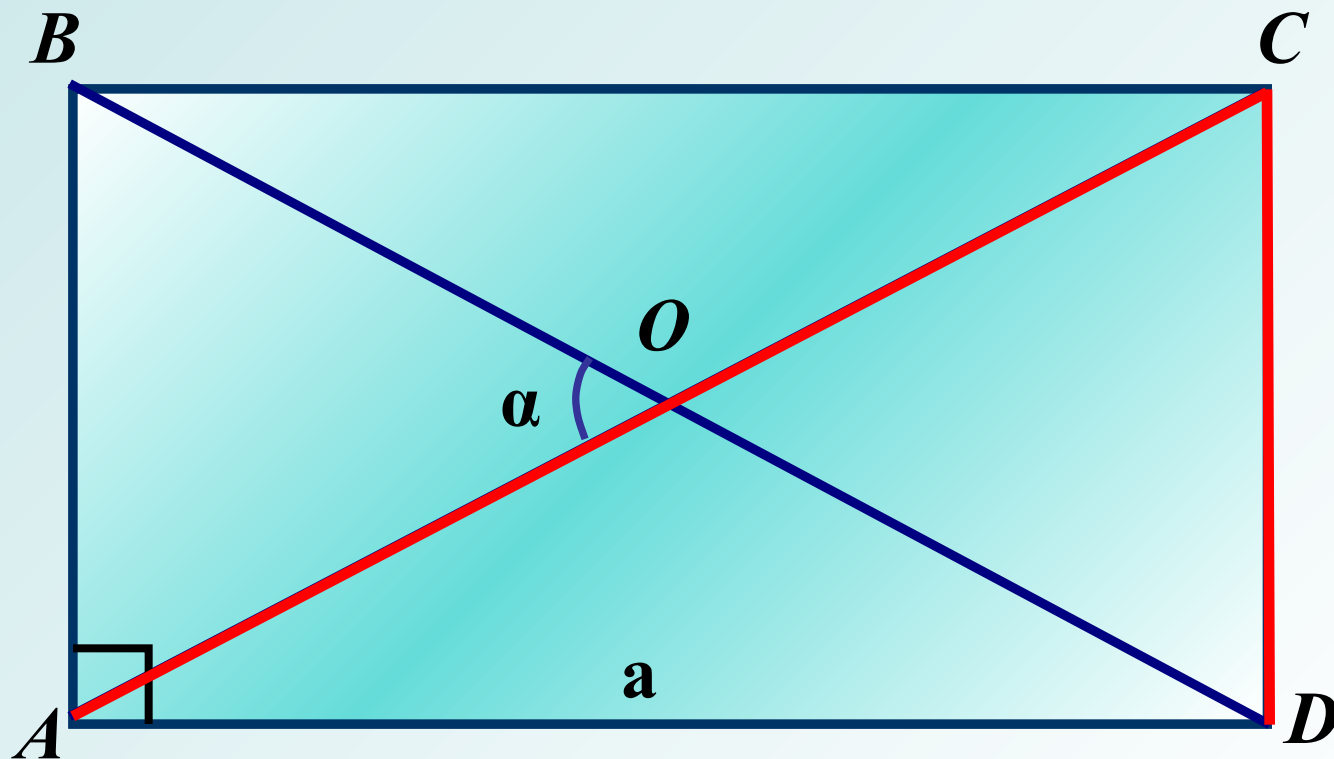

18.

Дано:  $ABCD$  –  $\square$

Найти:  $S_{ABCD}$

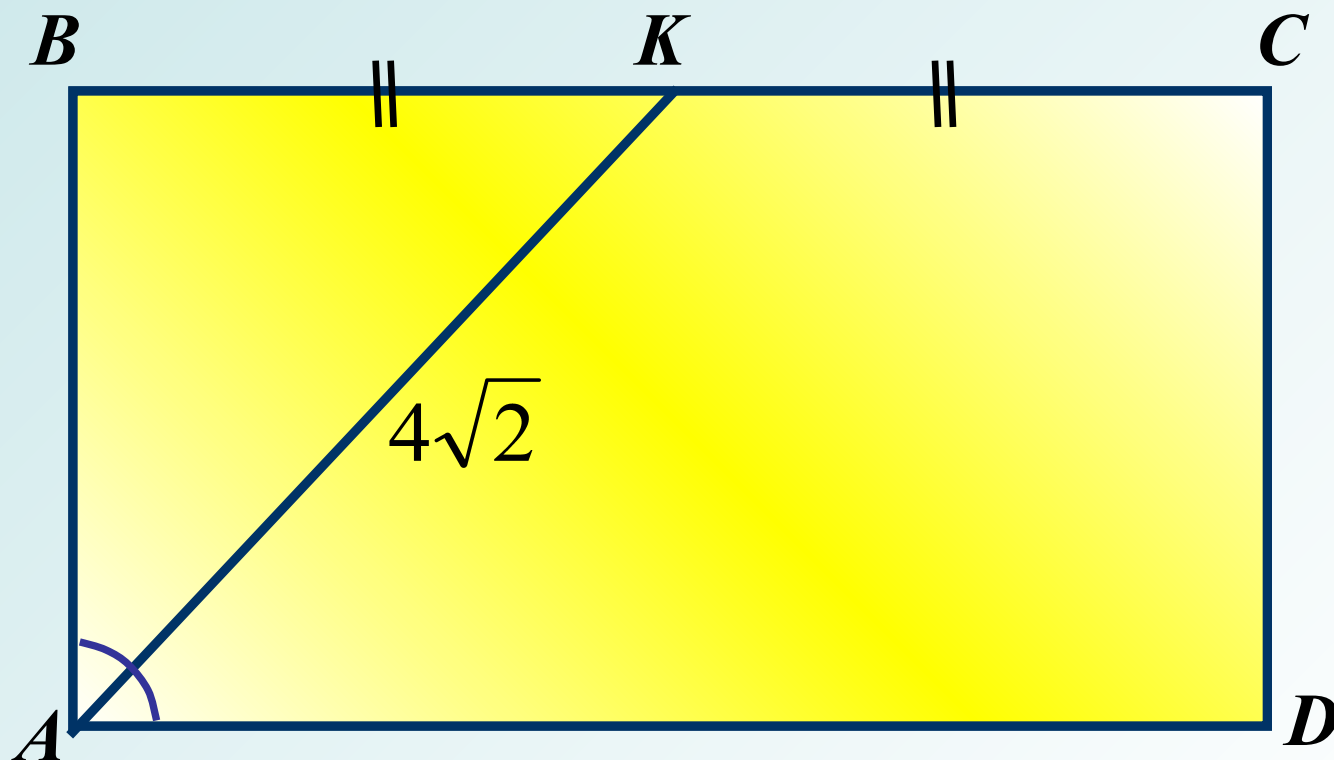

19.

**Дано:**  $MN : MK = 5 : 3$ ,  $AC + BC = 48$

**Найти:**  $MN$ ,  $MK$

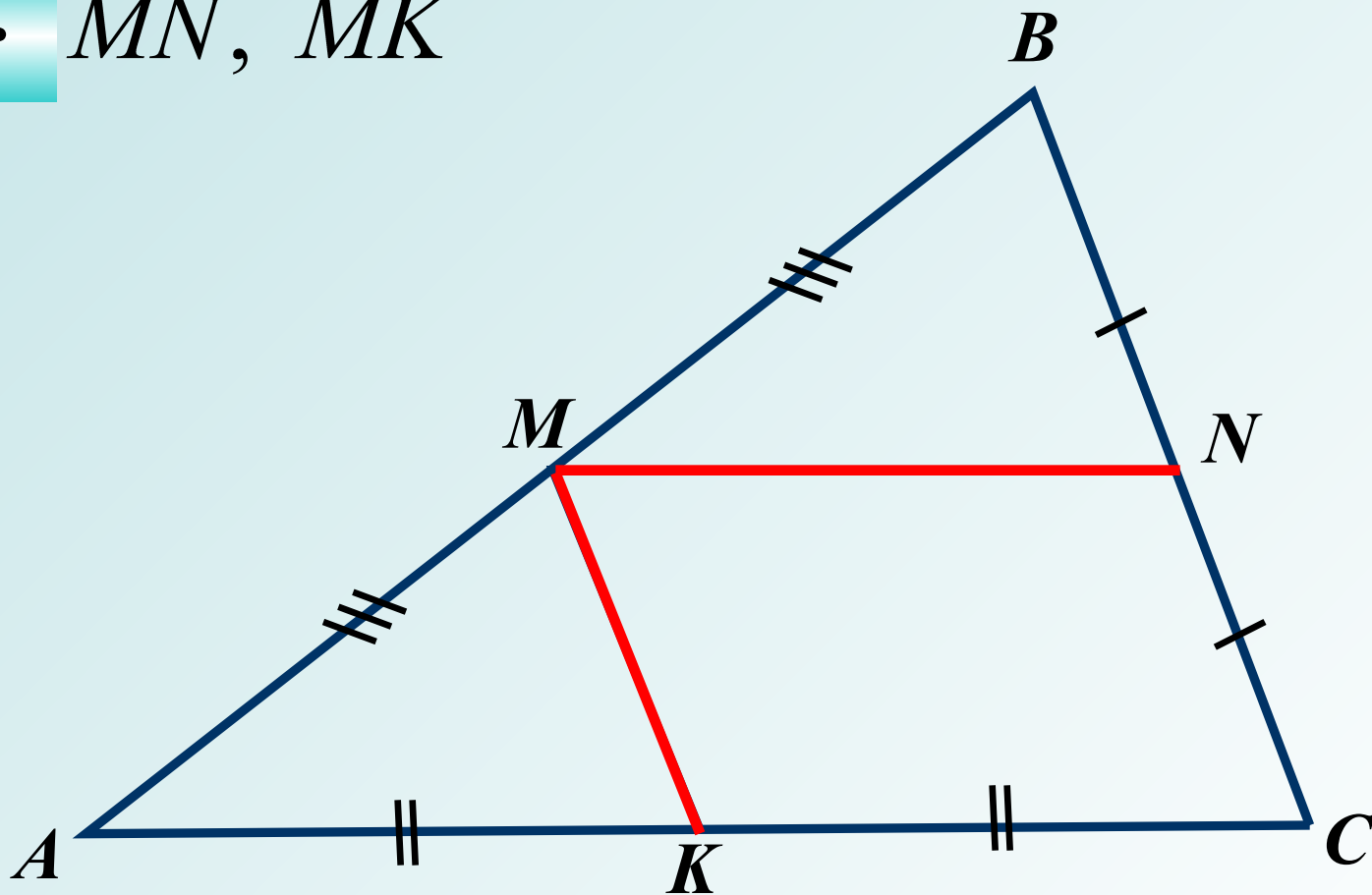

20.

Дано:

$ABM\hat{I}$  –  $i\delta y\grave{i}i\acute{o}\tilde{a}i\grave{e}u\grave{i}$   $i\grave{e}\hat{e}$

Найти:

$\hat{A}\hat{I}$

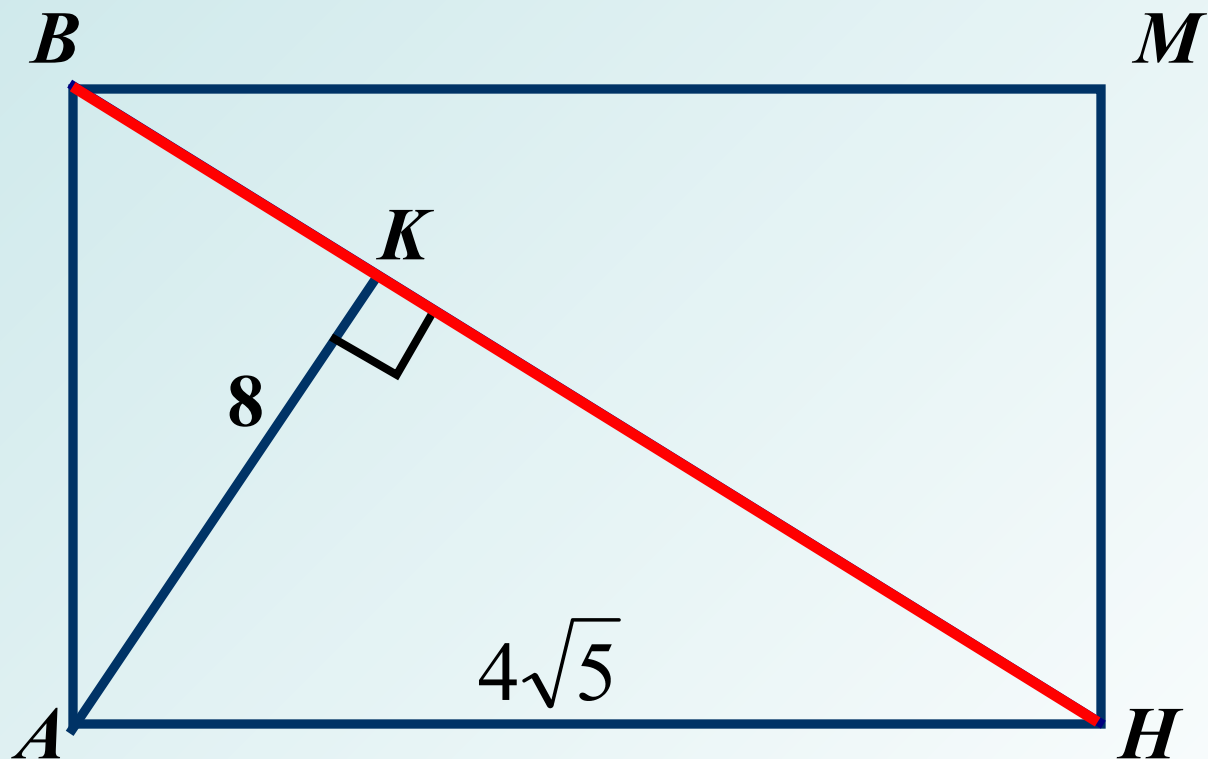

21.

Дано:

$AC \perp BD$  – о́дàíàóöèÿ

Найти:

$S_{ABCD}$

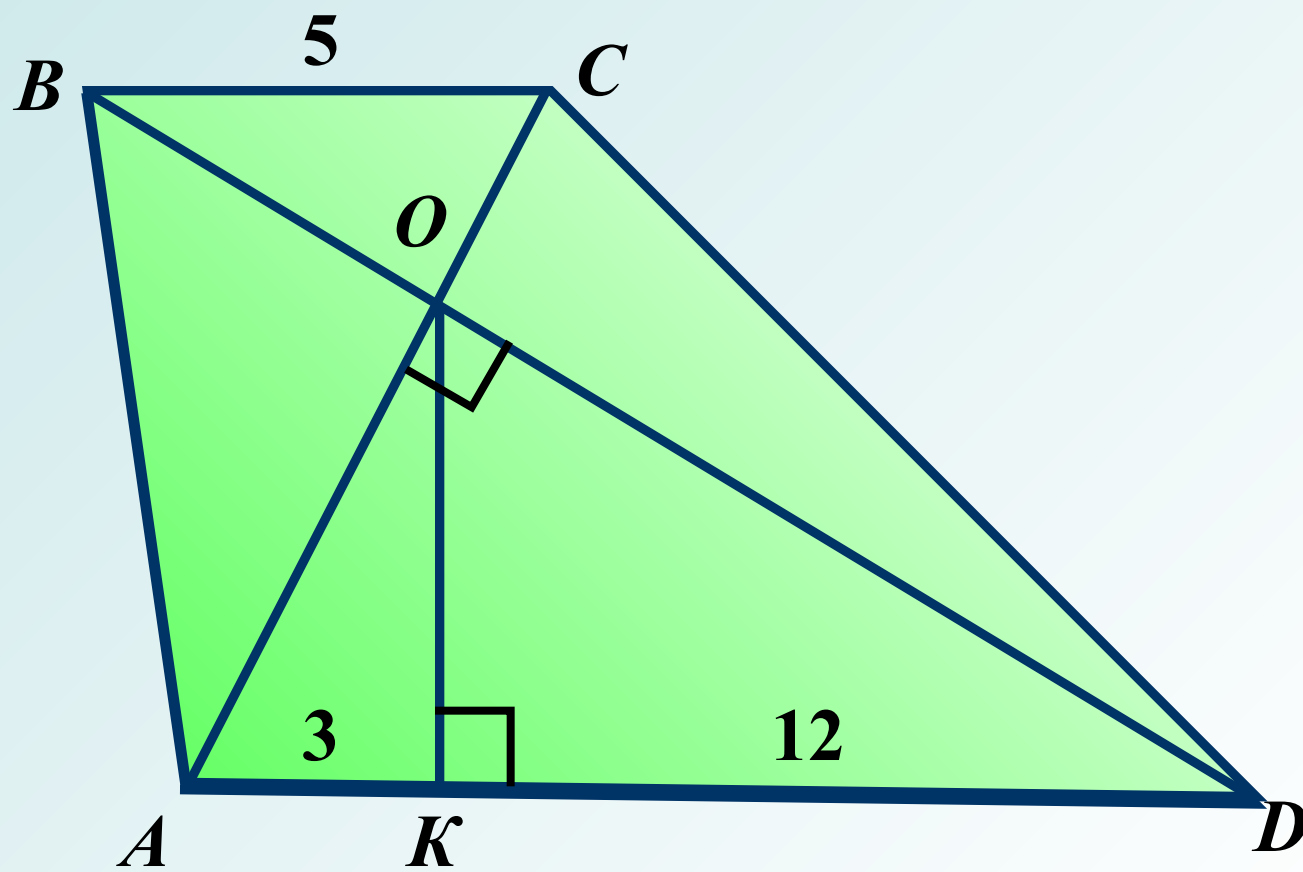

22.

Дано:

$\triangle MND$  –  $\triangle MNB$

$$MN = 10 \text{ см}$$

Найти:

$CF$

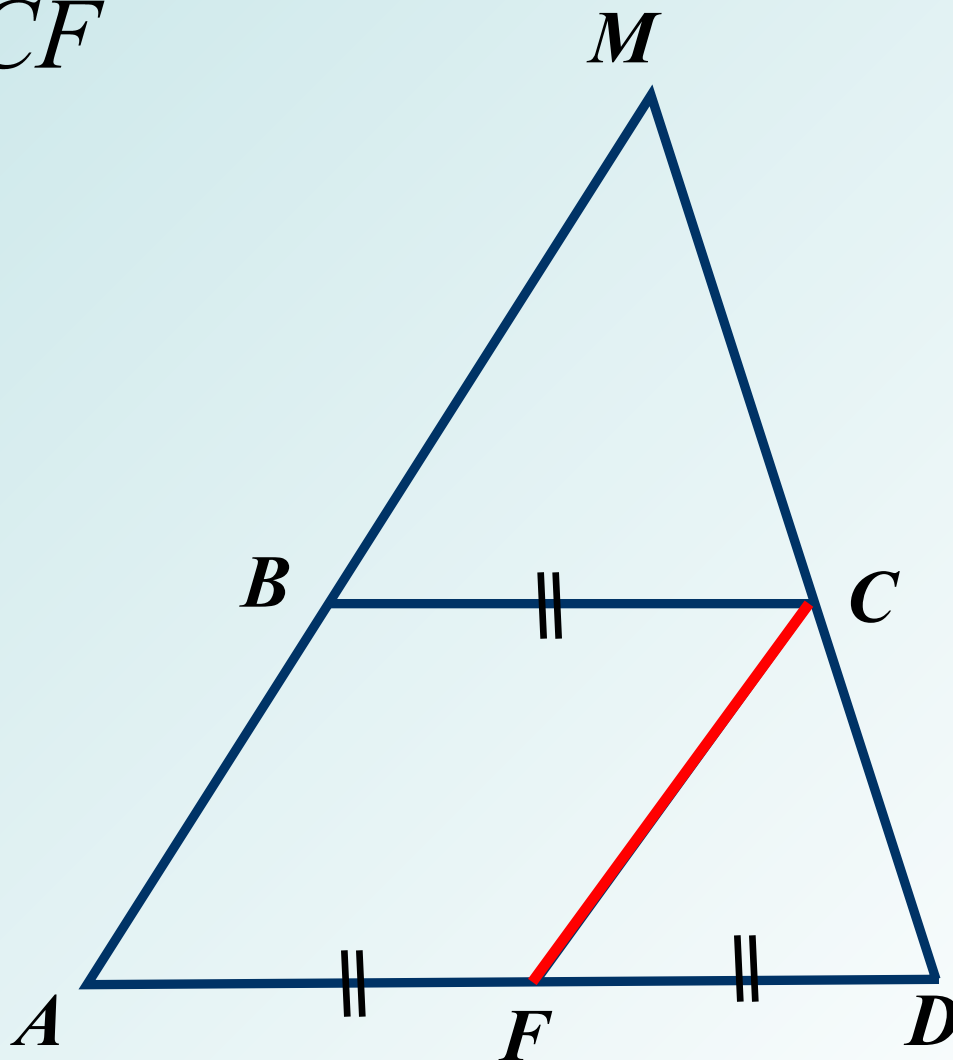



23.

Дано:

$\tilde{N}A\hat{I}A\hat{E}I\hat{I}A\hat{F}$

$$CA + AF + AE = 21$$

Найти:

$\tilde{N}A$ ,  $A\hat{E}$ ,  $A\hat{F}$

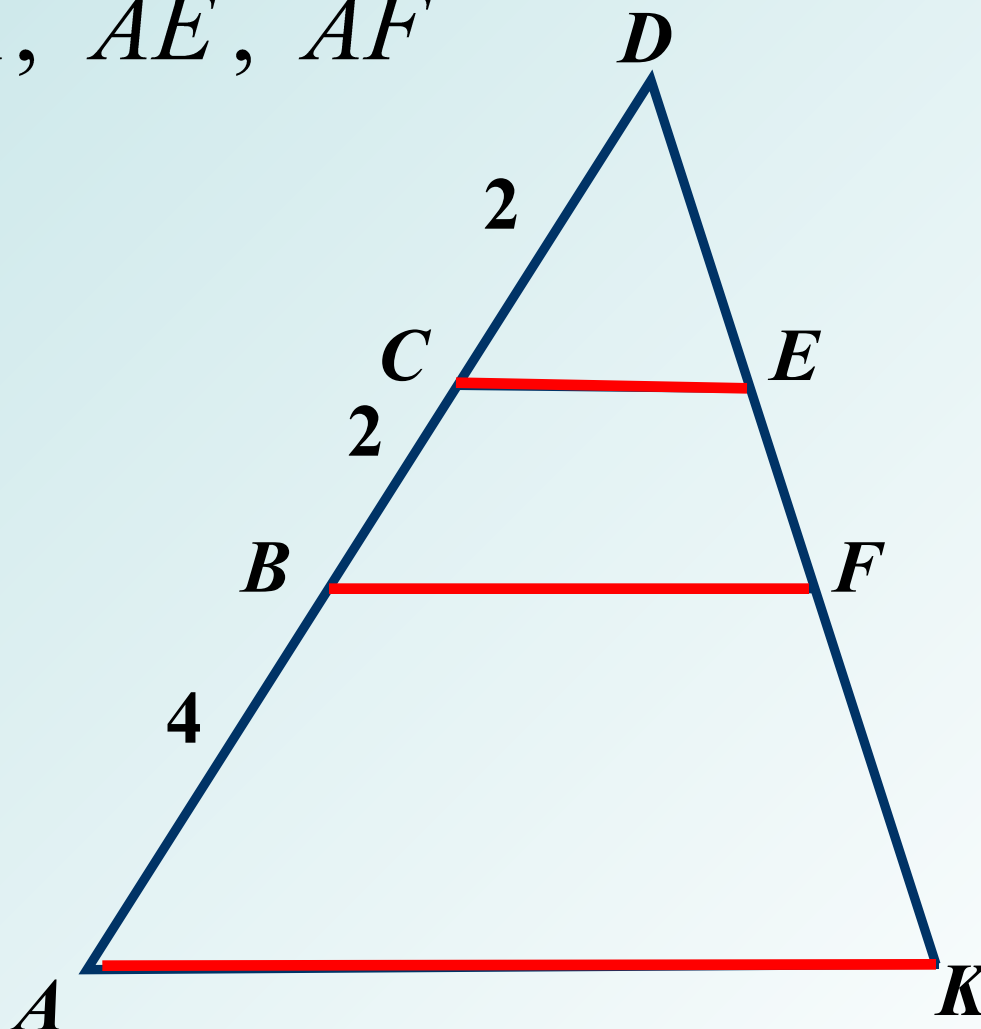

24.

*Дано:*

$$\hat{E}\hat{I}_1 = \hat{I}_1\hat{D}, \quad \hat{A}\hat{A}\hat{M}\hat{I}\hat{D}$$
$$\hat{A}\hat{B} = 18$$

*Найти:*

$\hat{I}\hat{D}$

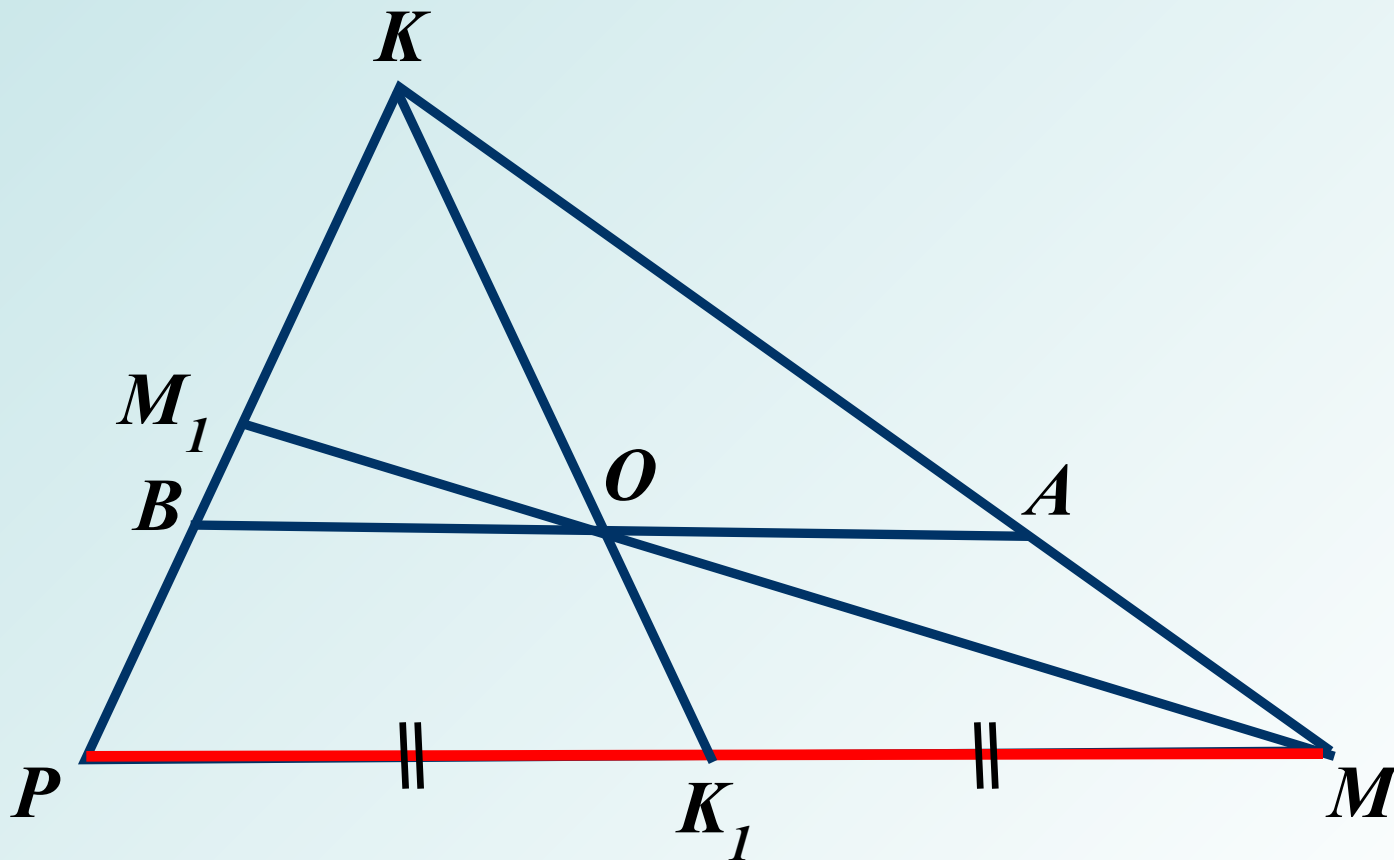

25.

Дано:  $\triangle ABC$

Найти:  $\hat{A}$

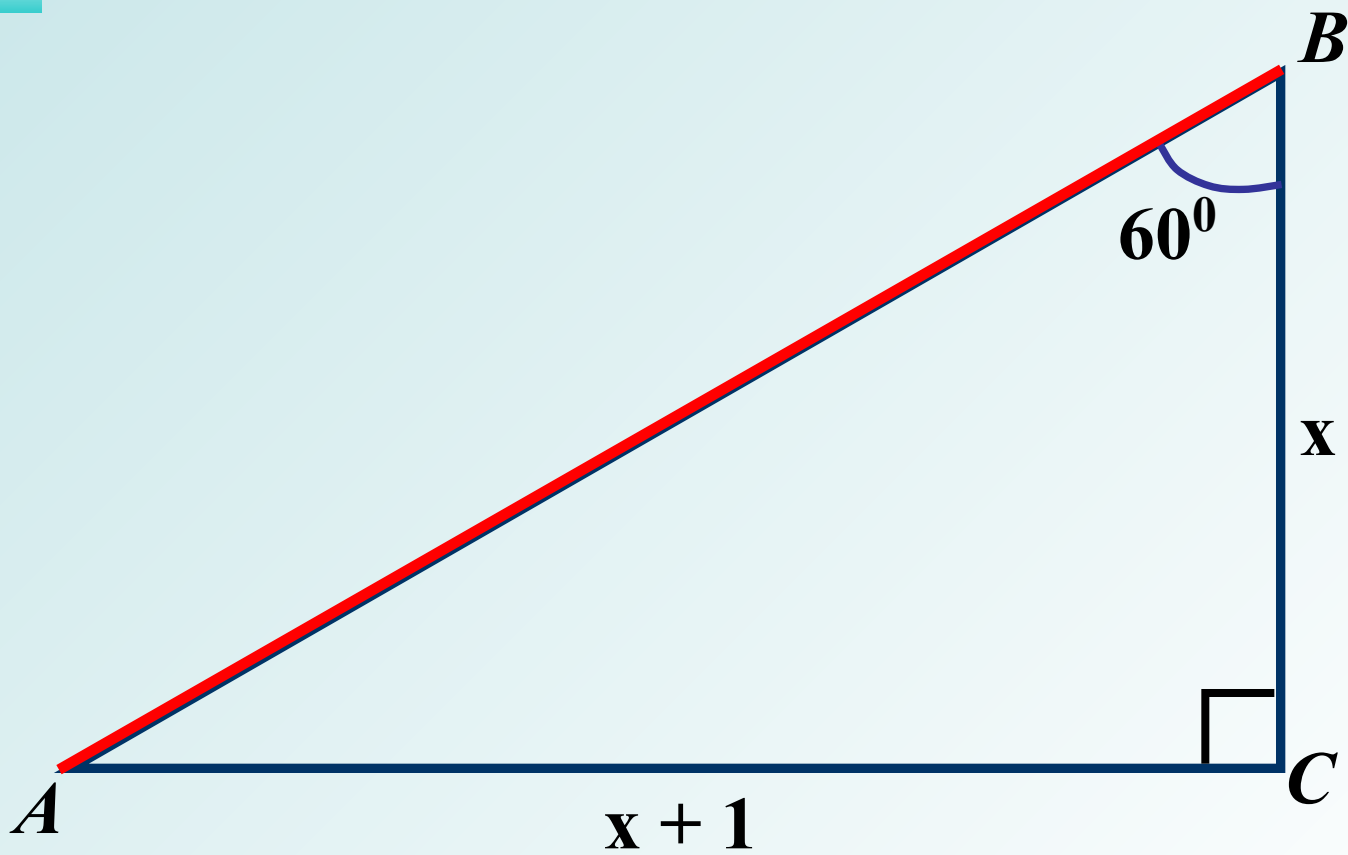

26.

Дано:

$ABCD$  – трапеция

$$\angle BAC = 2 \cdot \alpha$$

Найти:

$$S_{ABCD}$$

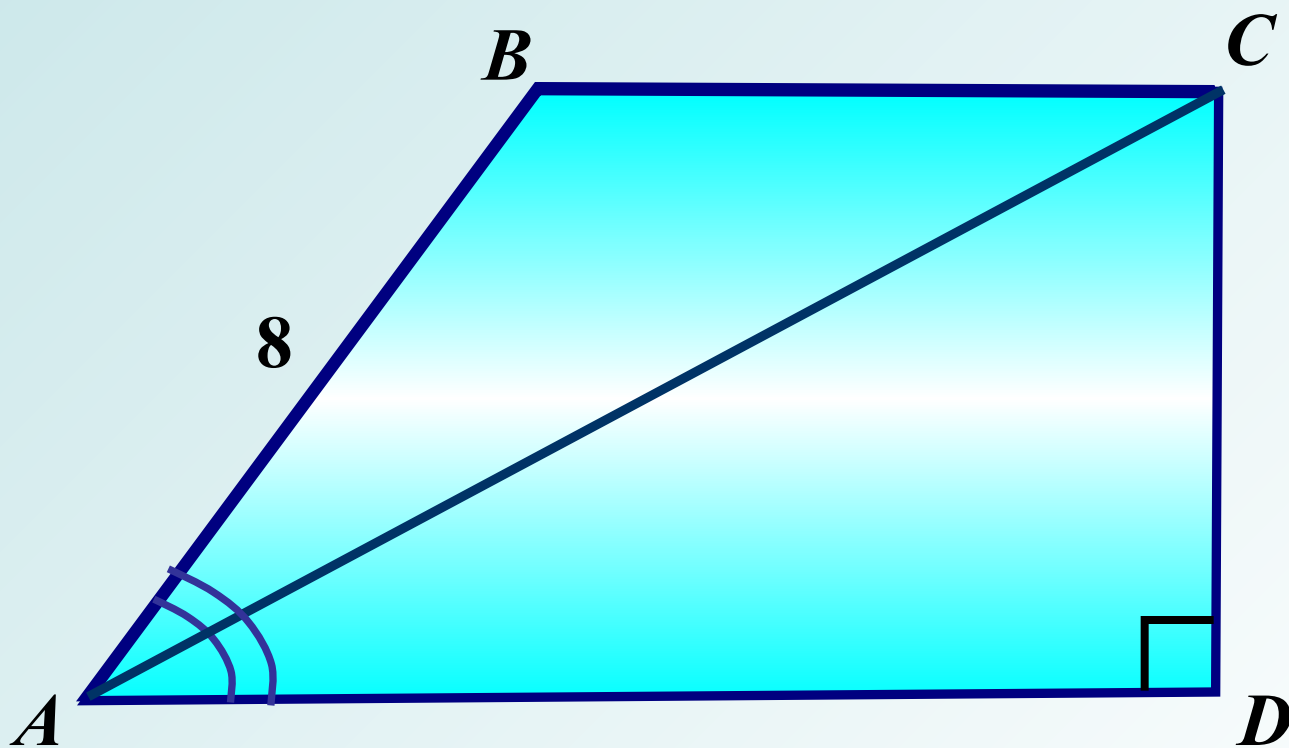

27.

Дано:  $ANND$  – одаіаөөё

Найти:  $AB$ ,  $BC$ ,  $S_{ABCD}$

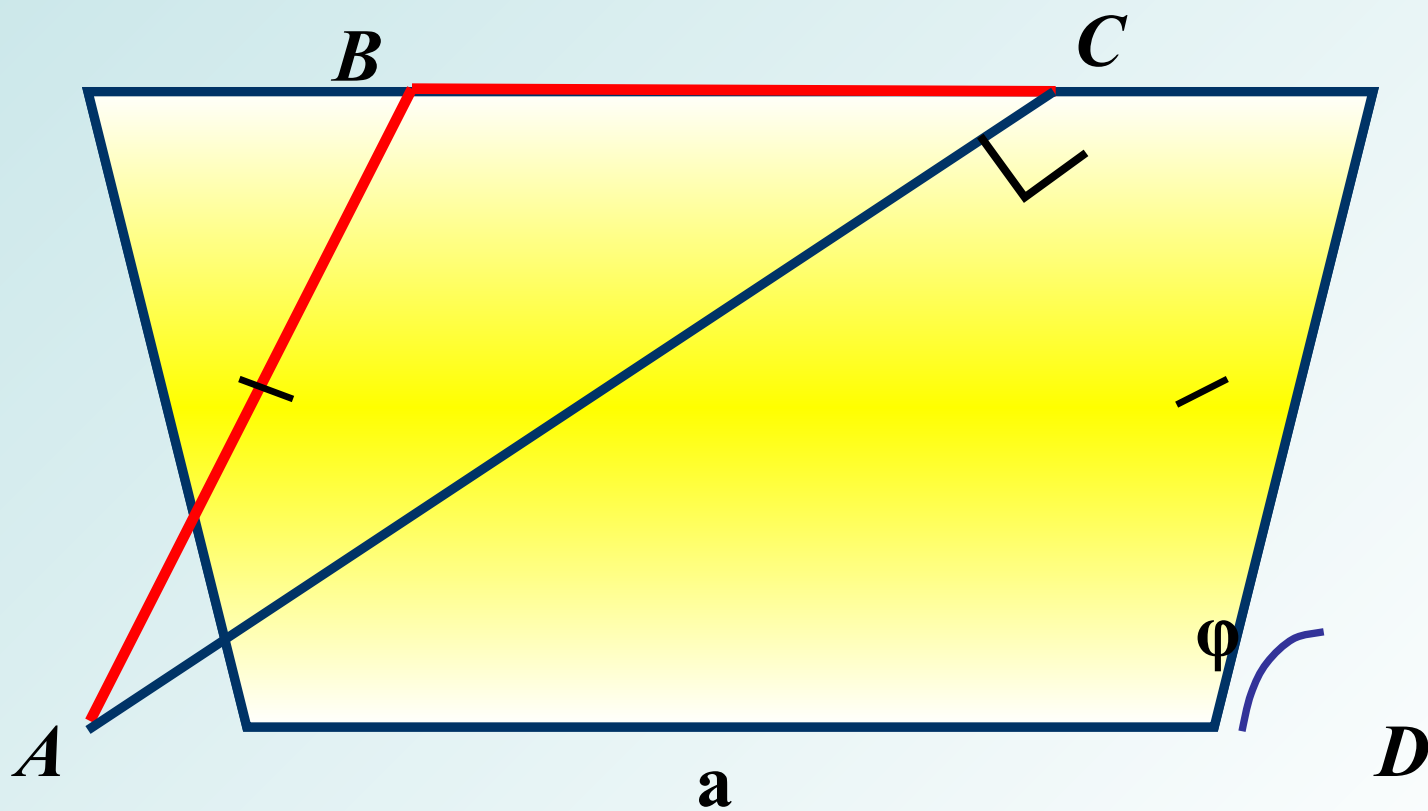

28.

Дано:  $ABCD$  – о́дàïàöèÿ

Найти:

$P_{ABCD}$

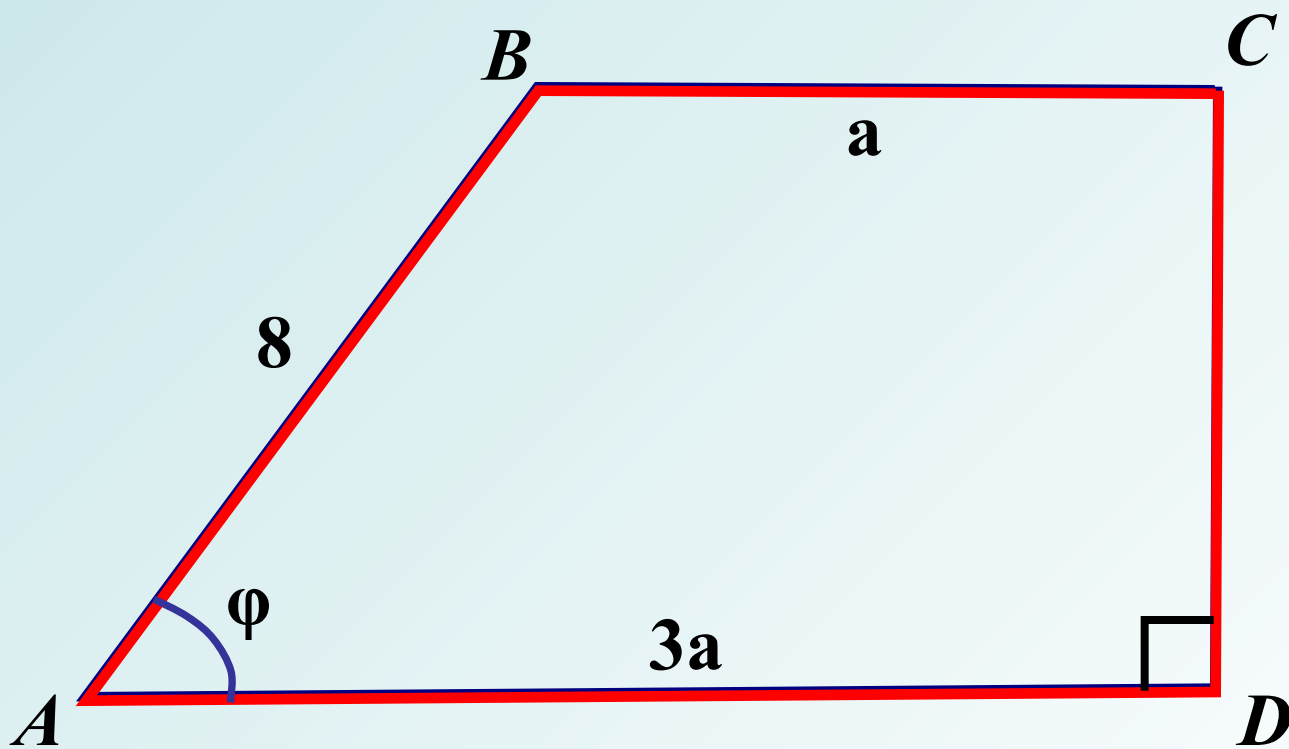

29.

Дано:

$ABCD$  – трапеция

$$\angle BAN = \beta$$

Найти:

$\angle D$

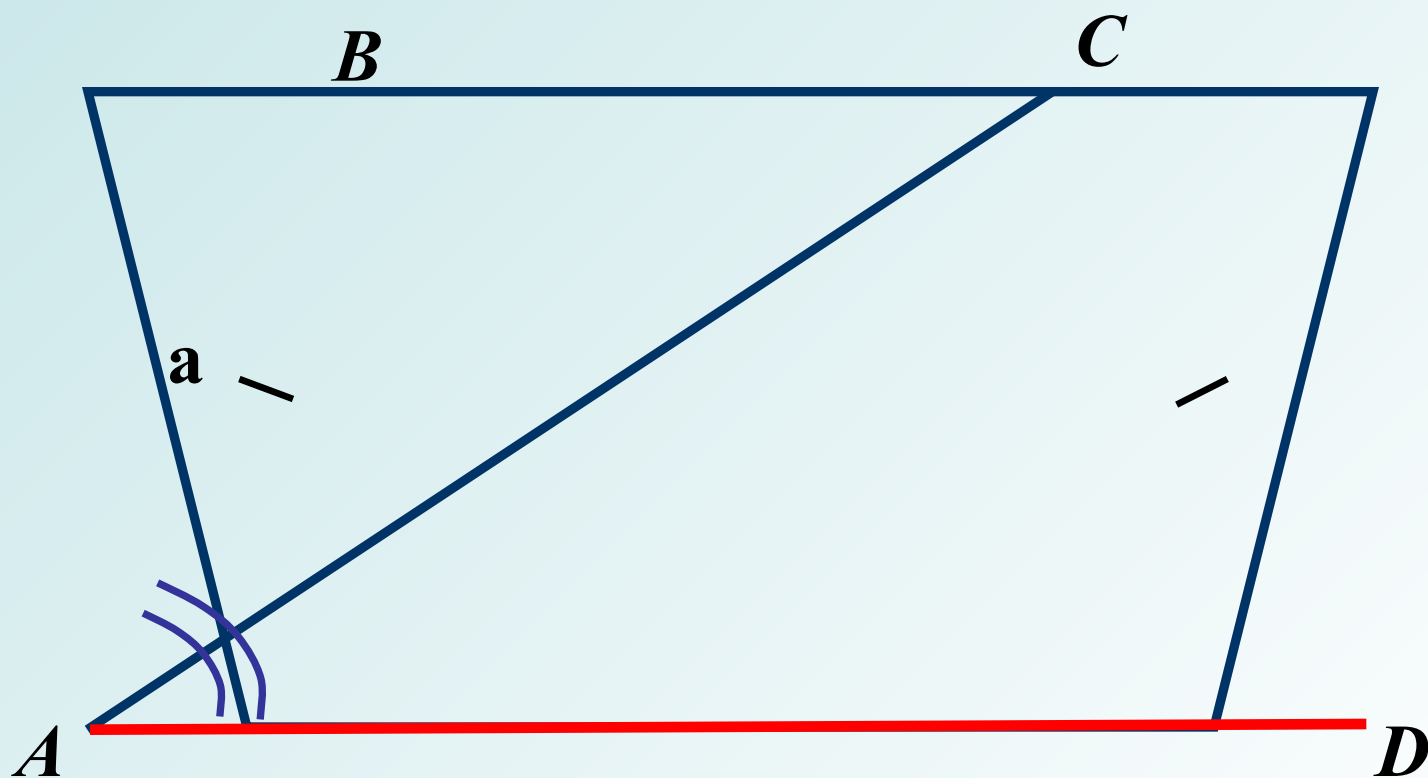

30.

Дано:  $\angle BOB_1$

Найти:  $AB$ ,  $A_1B_1$

