

# Элементы цифровой логики

Простейшие логические схемы

# Инверторы ( $Y = \bar{X}$ )

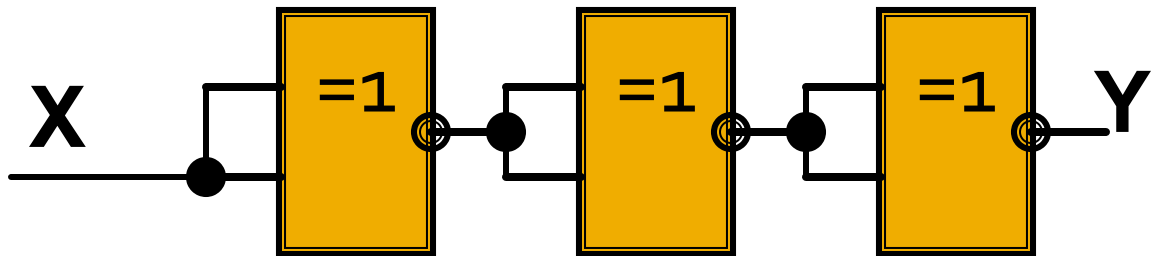
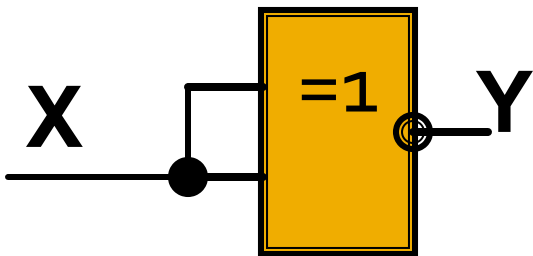
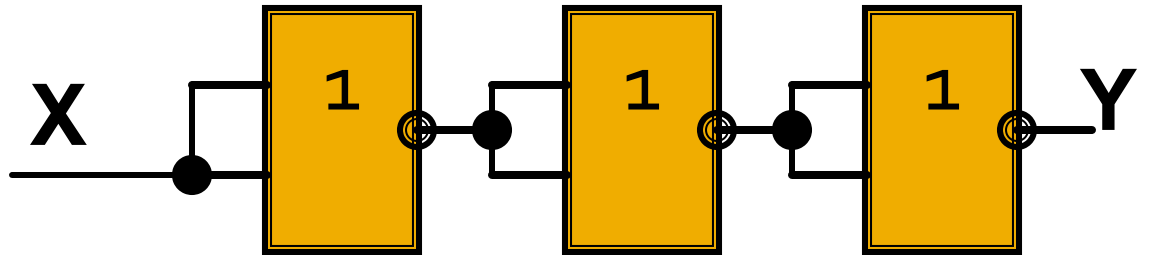
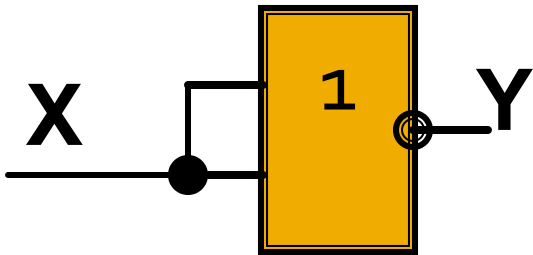
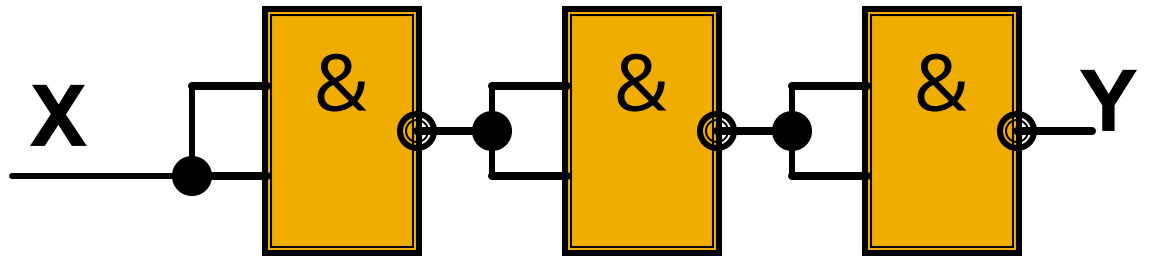
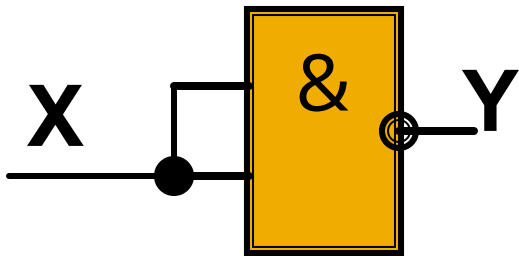
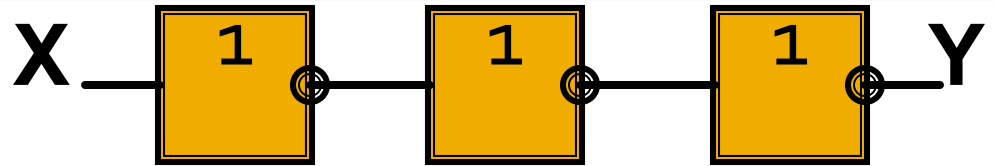
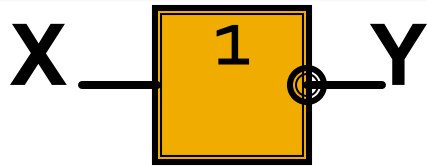

# Повторители ( $Y=X$ )

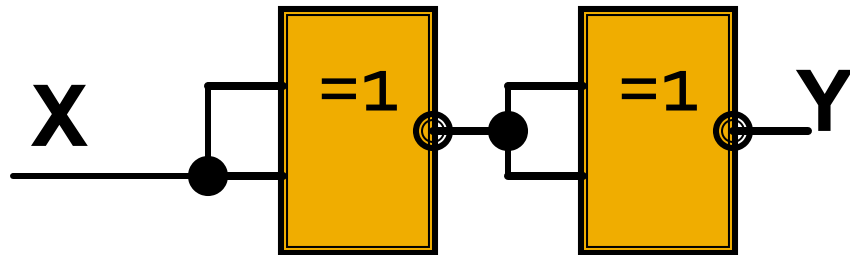
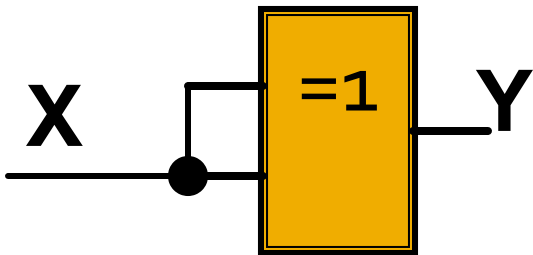
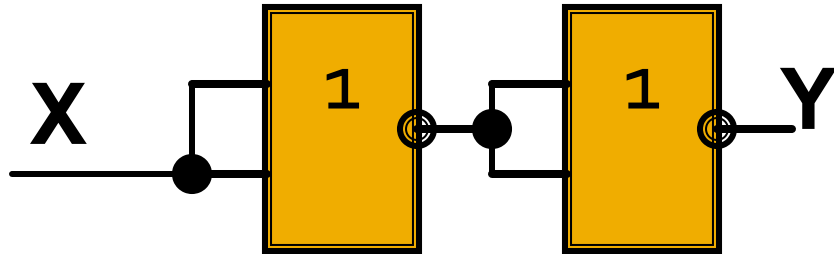
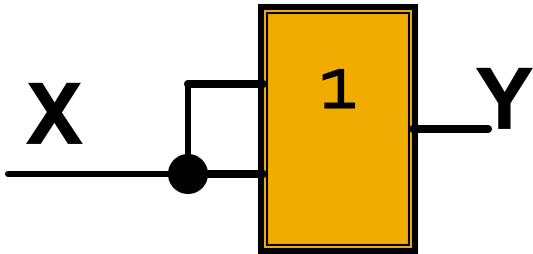
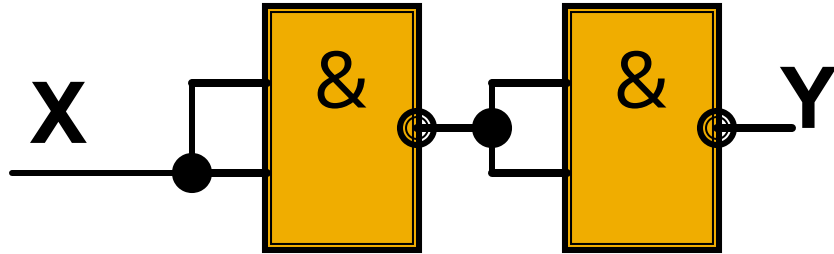
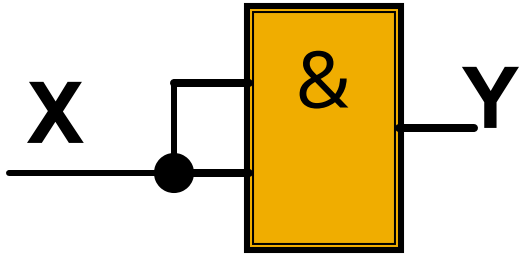
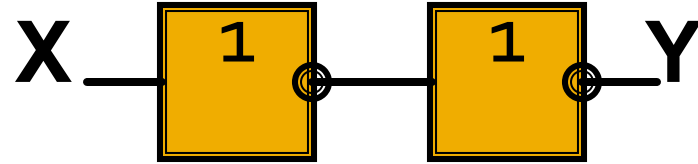
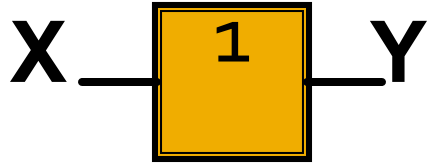

# Инверторы ( $Y = \bar{X}$ )

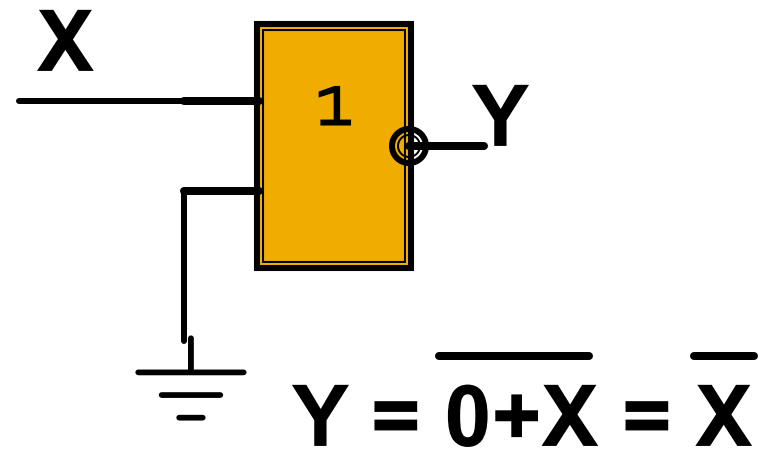
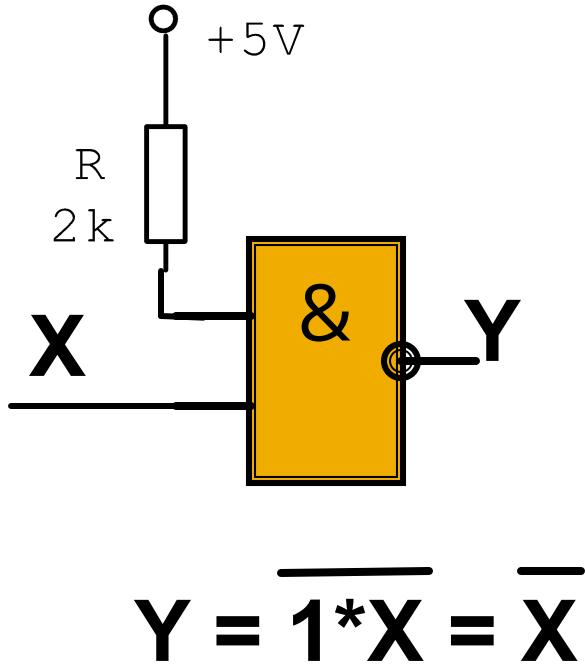

# Повторители ( $Y=X$ )

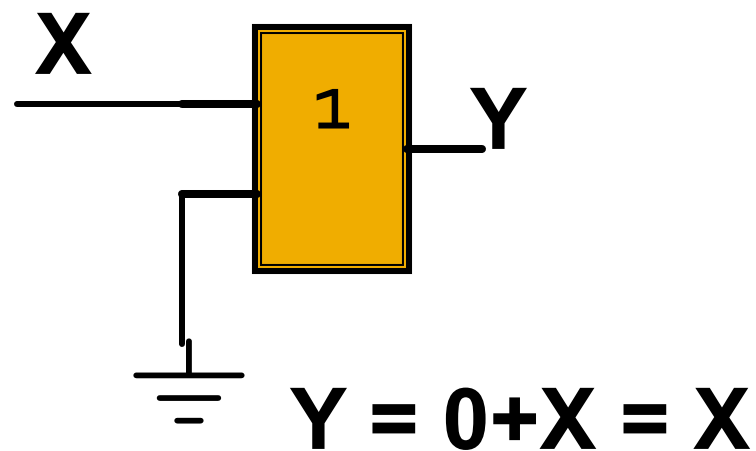
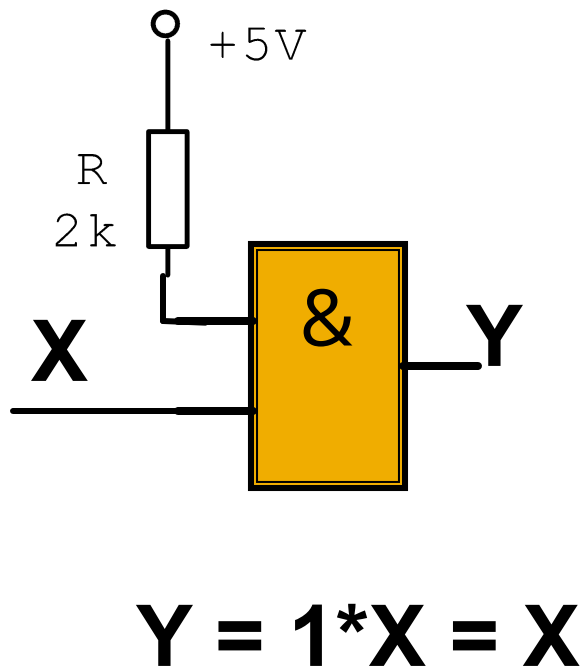

# Задание уровня лог "1"

$D_0=D_1=D_2=D_3="1"$

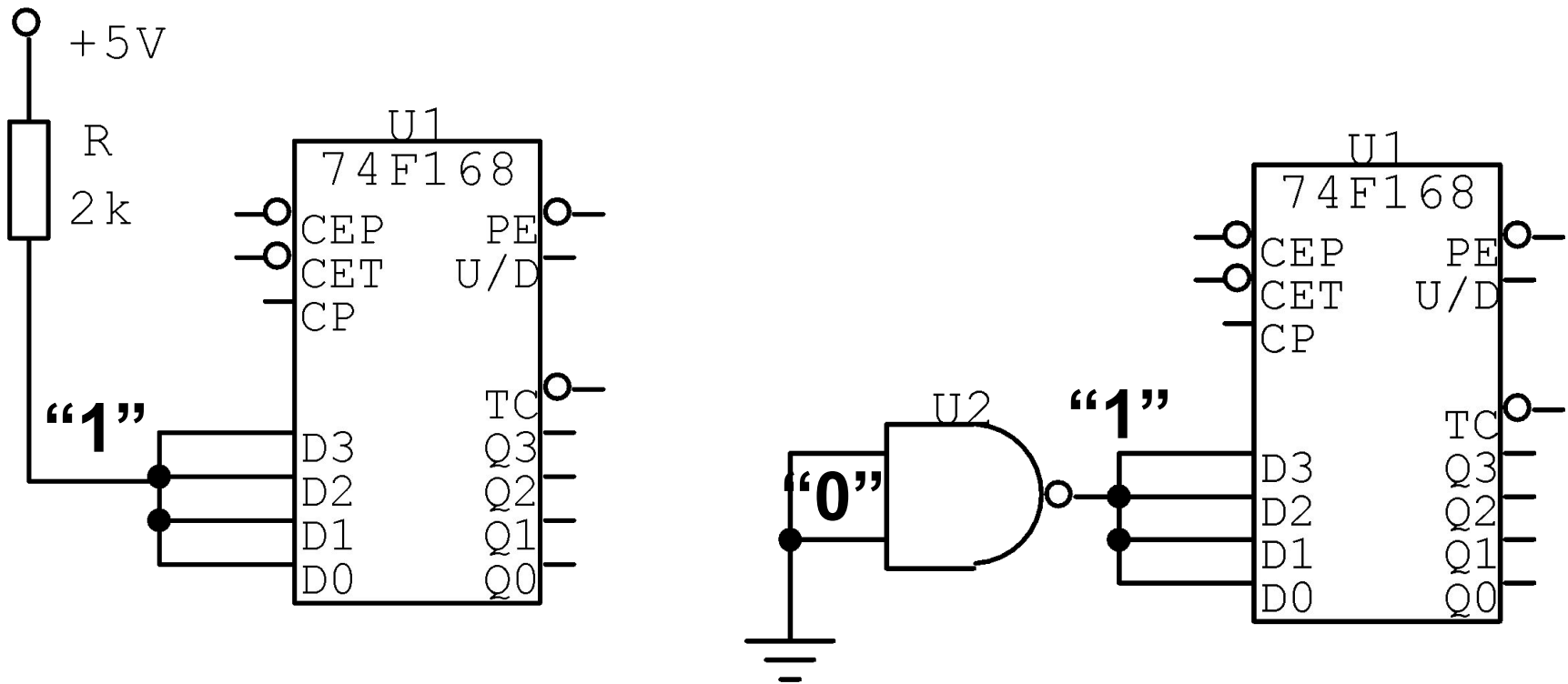

# Задание уровня лог "0"

$D_0=D_1=D_2=D_3="0"$

