

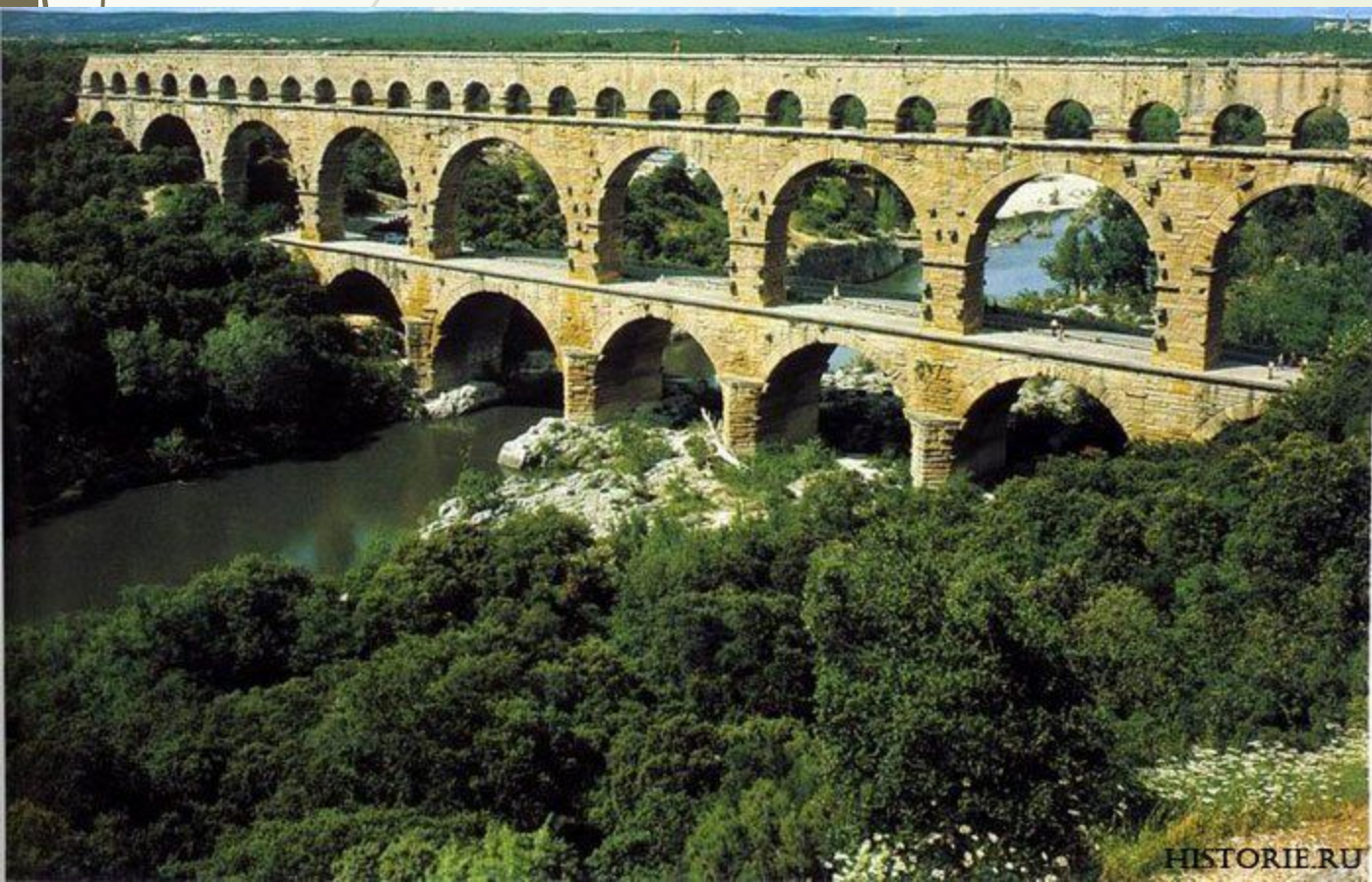

# Архитектура Византии





# Х-ХІ вв. крестово-купольные храмы

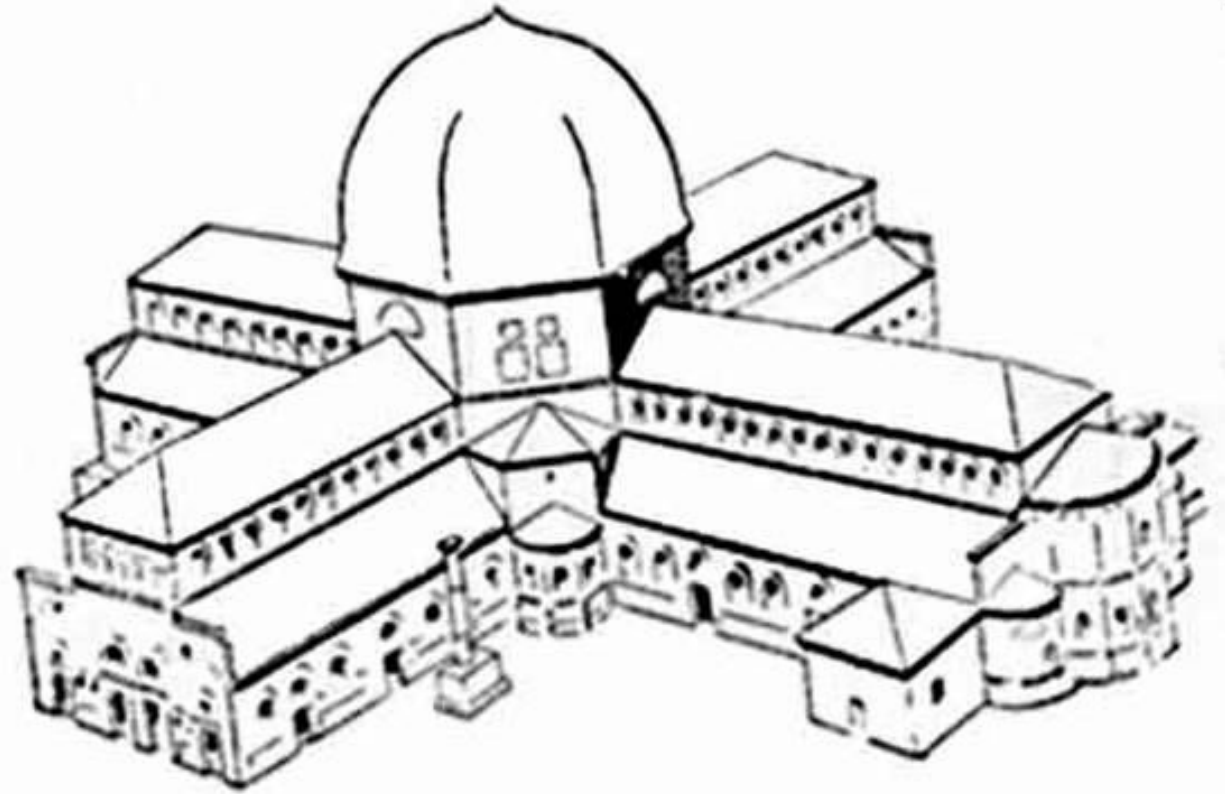
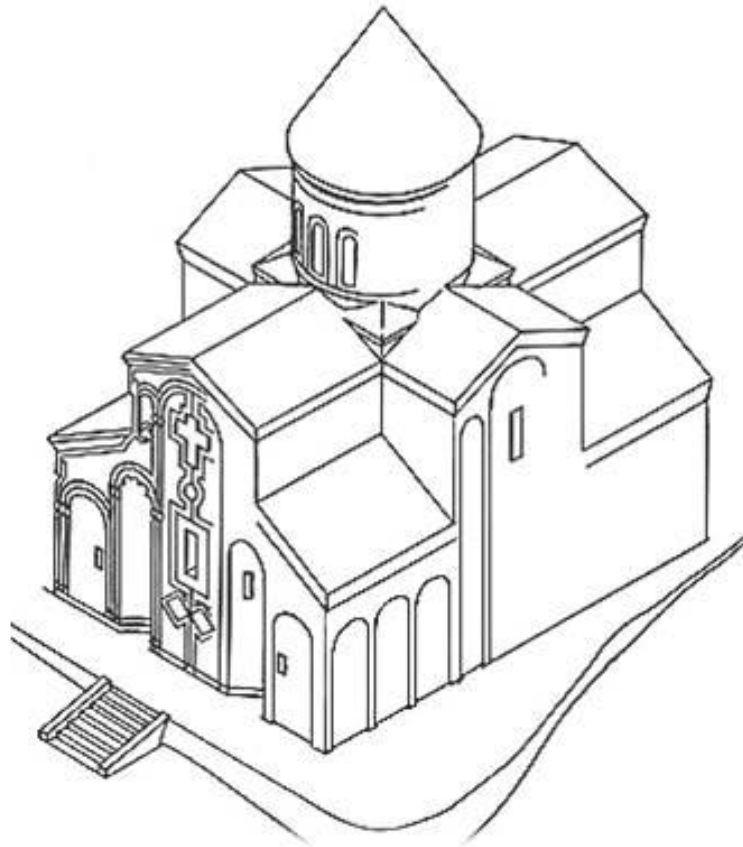

# Купольная базилика

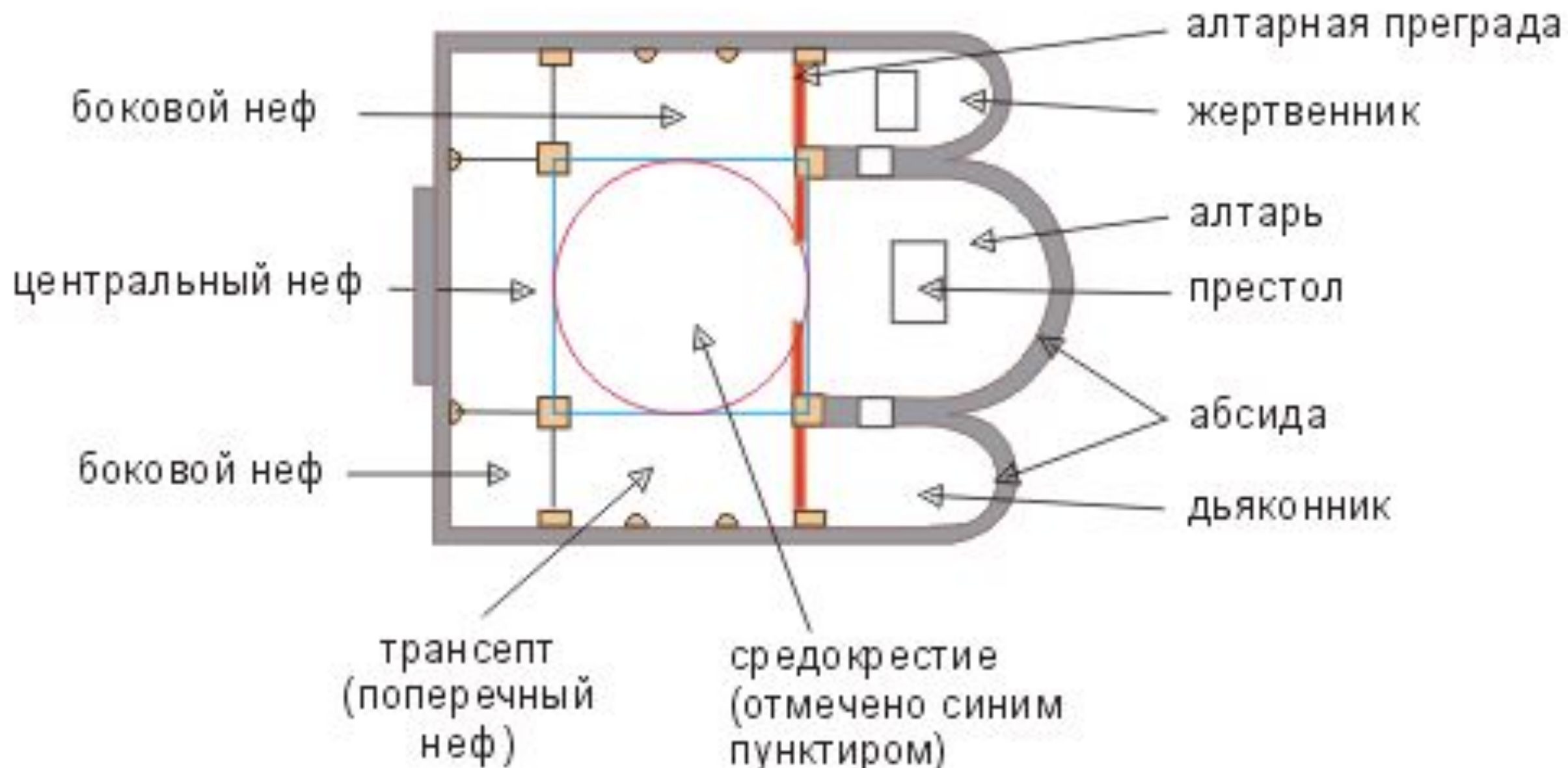



a)

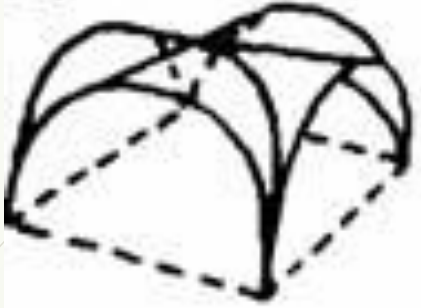

б)



в)



г)

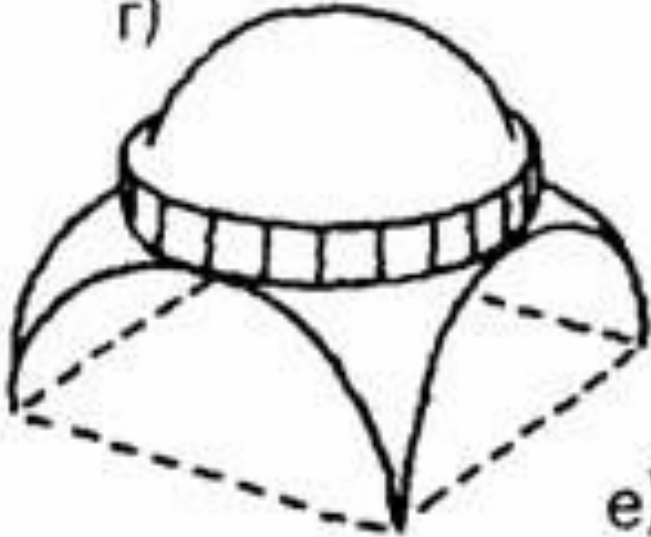

д)

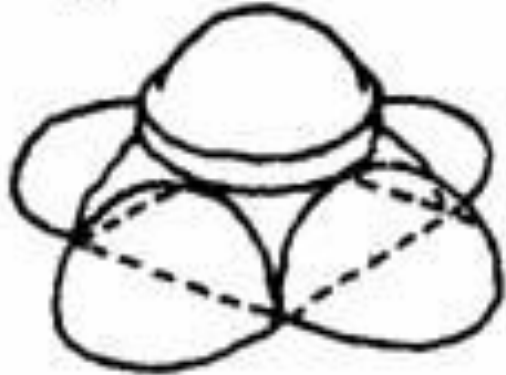

е)

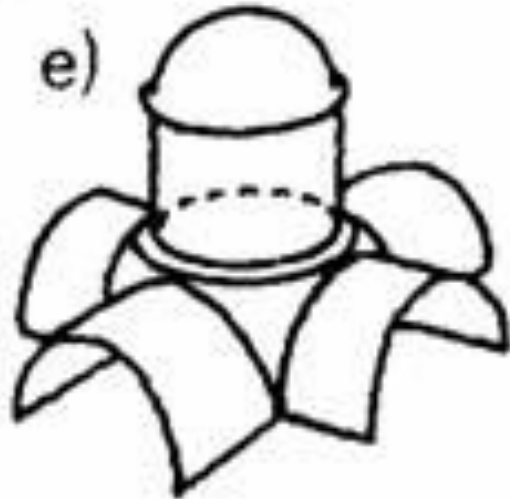

# Тромпы

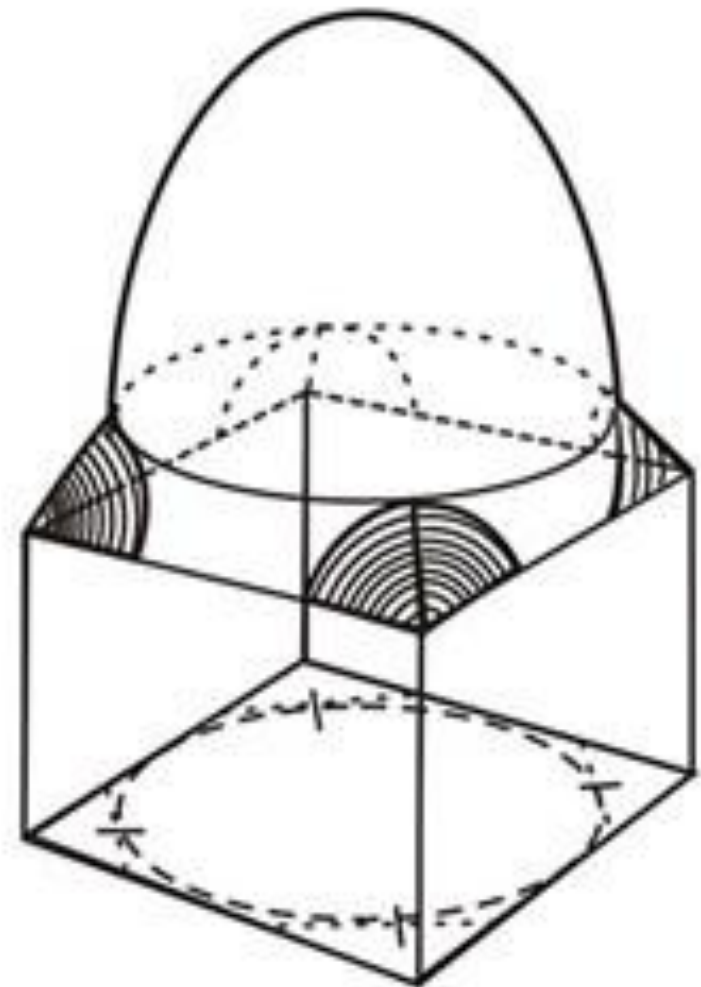

© ООО «Старик и Мефодей»



**Собор  
святой  
Софии в  
Константи  
нополе  
(527 г.)**



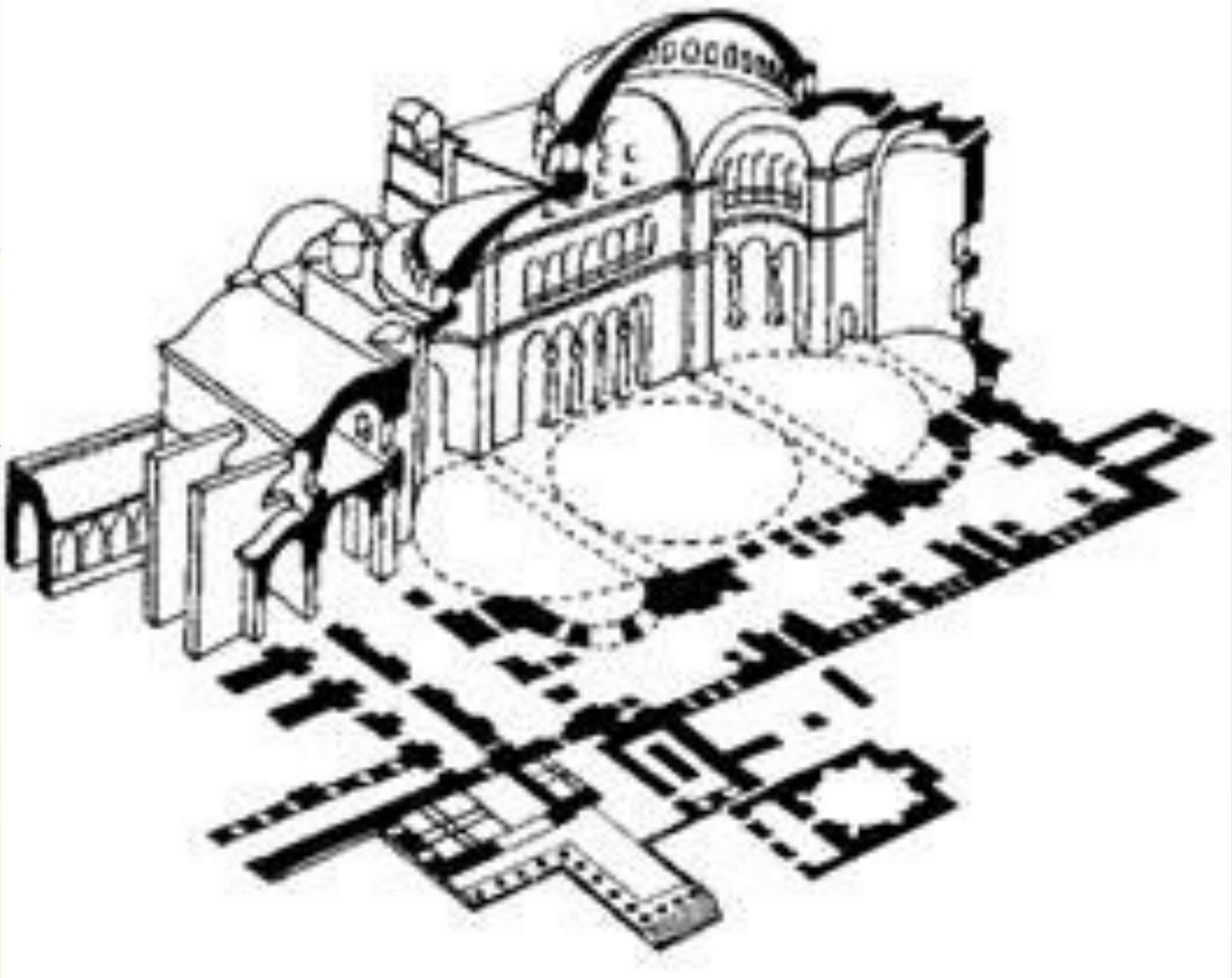



# Церковь Святой Ирины в Константинополе (IV век)



The existing square-headed Turkish windows are shown within the original semicircular-headed openings. The pedestals below the columns of nave arcade are at present cased in wood; one of these was uncovered, and was found to be a roughly-squared stone block; there is evidence that two others are similar.

# S. IRENE LONGITUDINAL SECTION

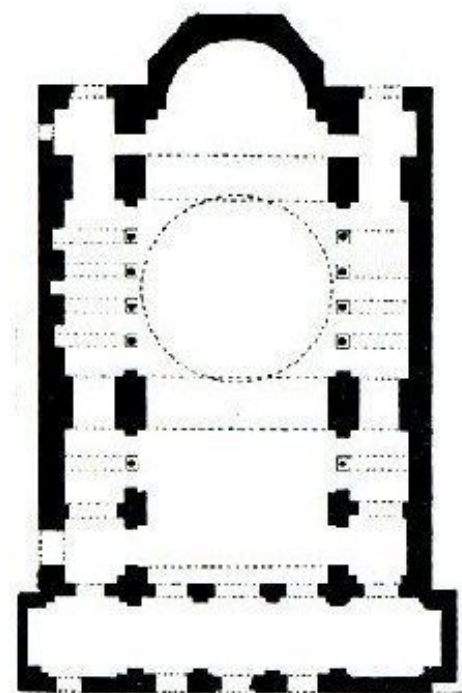
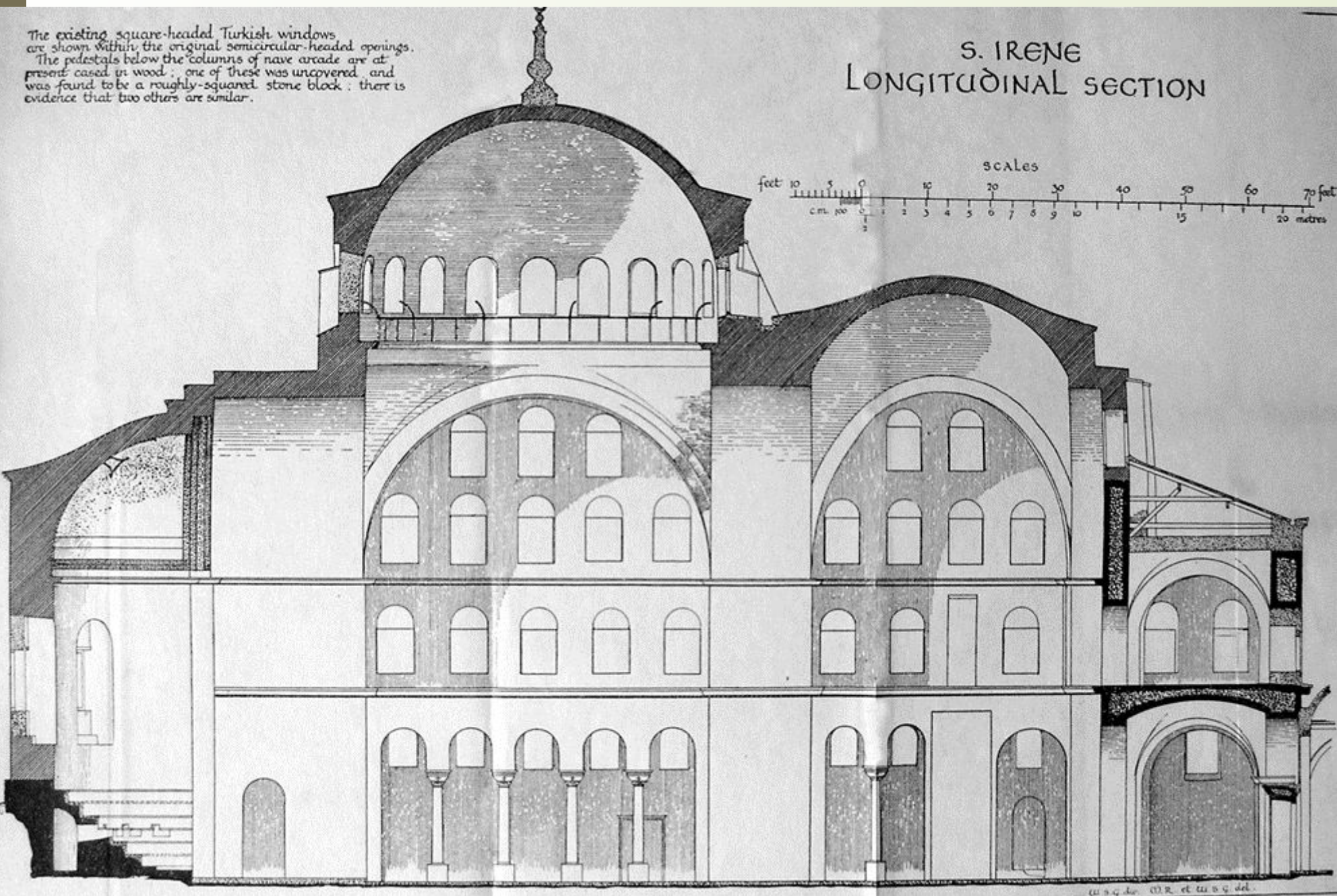
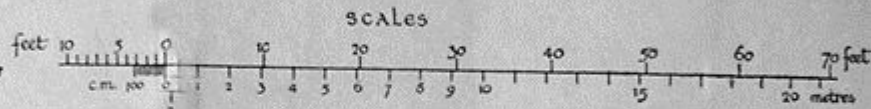

Церковь св. Ирины  
в Константинополе.

# Аркады на колоннах

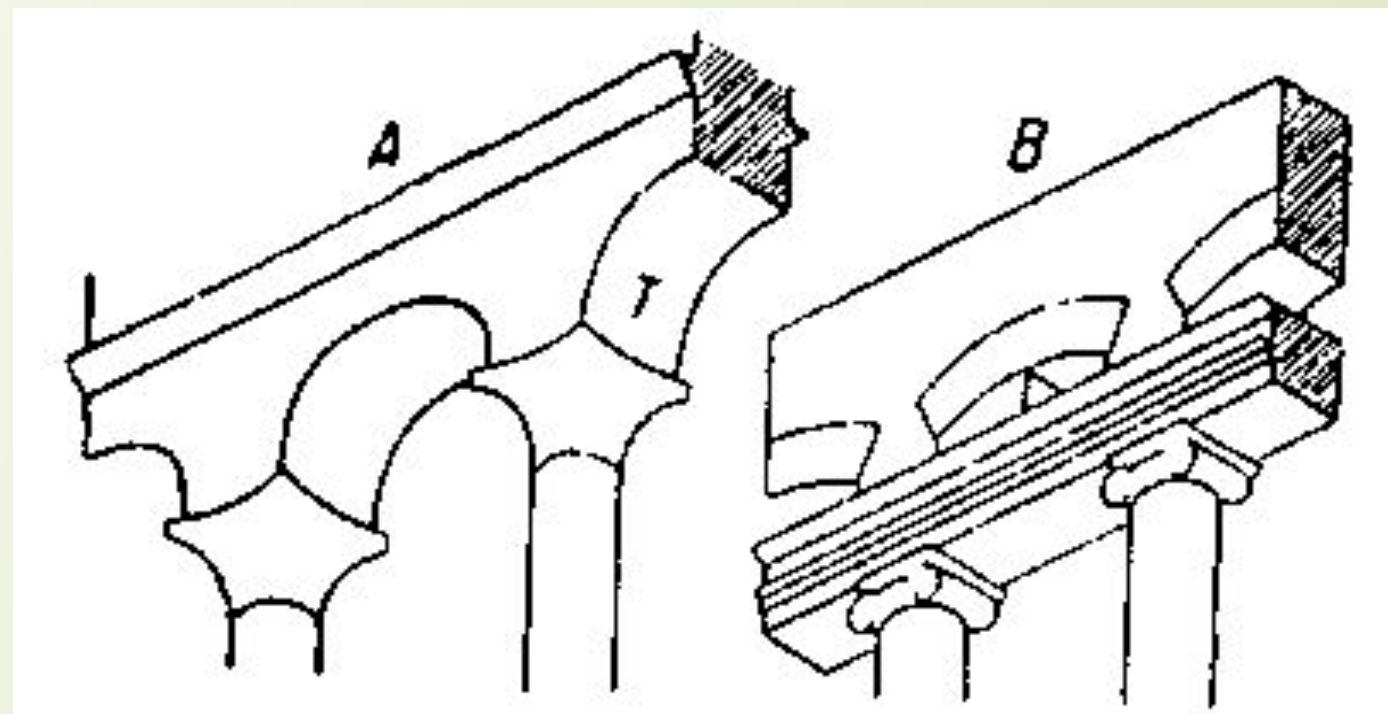

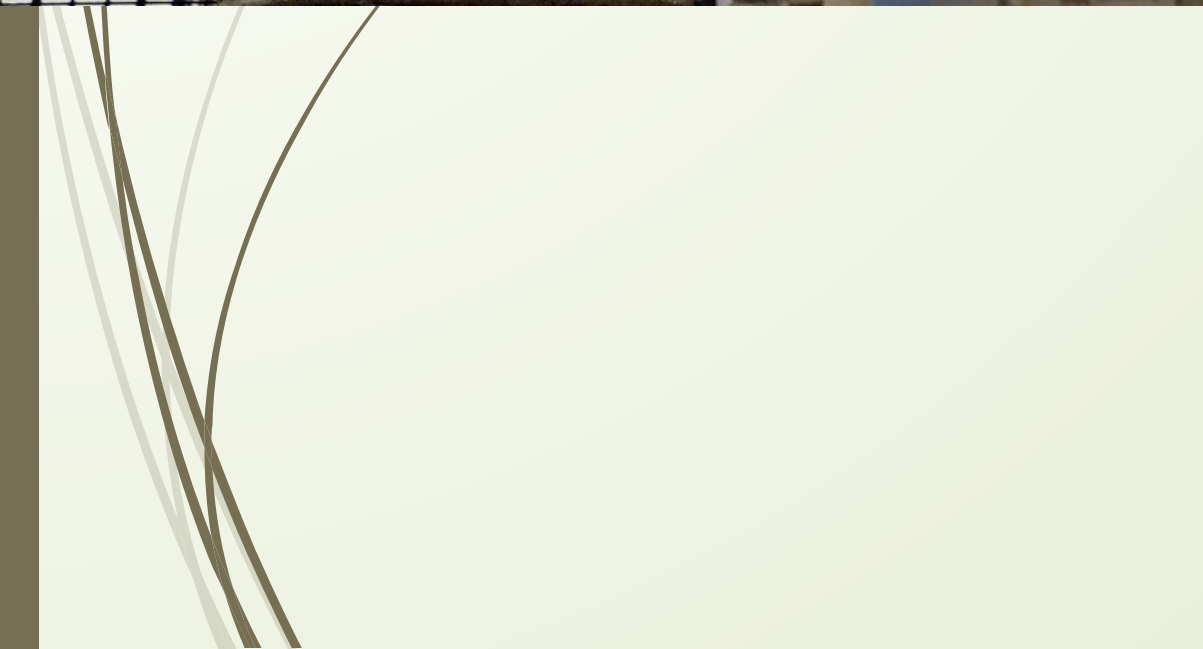

# Плинфа







Церковь эпохи Византии на Кипре

# Византийская церковь Panagia





*Вестибюль Коридор Атрий Ала Таблиний Перистиль Экседра*

