

# THE HISTORY OF ARCHITECTURE

FROM PREHISTORIC TO MODERN TIMES

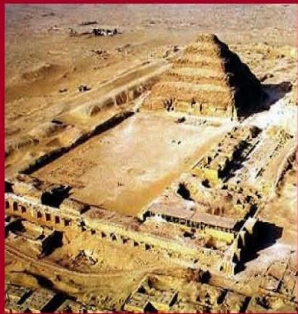

the third Album:

## THE ANCIENT EGYPT'S ARCHITECTURE

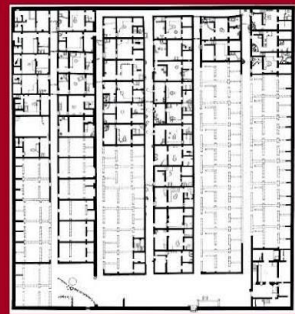

**Albums of characteristic examples for the Educational course**

**by Dr. Konstantin I.Samoilov**

Almaty, 2017

**This series of albums generated for information purposes of the Educational course "The General History of Architecture": 2 credits / 30 hours of lectures.**

Until the mid-19<sup>th</sup> century, examples are grouped by region. In this period, the phenomenon of a single world architectural process begins to manifest itself. Since the last third of the 19<sup>th</sup> century, examples have been grouped by decades.

**Thirty albums illustrate the following topics:**

- the 1<sup>st</sup> Album: EDUCATIONAL AND SCIENTIFIC-THEORETICAL SOURCES
- the 2<sup>nd</sup> Album: THE PREHISTORIC ERA'S ARCHITECTURE
- **the 3<sup>rd</sup> Album: THE ANCIENT EGYPT'S ARCHITECTURE**
- the 4<sup>th</sup> Album: THE ANCIENT MESOPOTAMIAN ARCHITECTURE
- the 5<sup>th</sup> Album: THE ANCIENT GREECE'S ARCHITECTURE
- the 6<sup>th</sup> Album: THE ANCIENT ROME'S ARCHITECTURE
- the 7<sup>th</sup> Album: THE MEDIEVAL WEST EUROPEAN ARCHITECTURE
- the 8<sup>th</sup> Album: THE EUROPEAN RENAISSANCE'S ARCHITECTURE
- the 9<sup>th</sup> Album: THE MEDIEVAL MAGHREB'S, THE NEAR EASTERN AND THE CAUCASUS'S ARCHITECTURE
- the 10<sup>th</sup> Album: THE MEDIEVAL CENTRAL ASIAN ARCHITECTURE
- the 11<sup>th</sup> Album: THE MEDIEVAL CHINESE ARCHITECTURE
- the 12<sup>th</sup> Album: THE MEDIEVAL SOUTHEAST AND EAST ASIAN ARCHITECTURE
- the 13<sup>th</sup> Album: THE MEDIEVAL CENTRAL AMERICAN ARCHITECTURE
- the 14<sup>th</sup> Album: THE EASTERN EUROPE MIDDLE AGES AND NEW TIMES ARCHITECTURE
- the 15<sup>th</sup> Album: THE WESTERN EUROPEAN AND NORTH AMERICAN OF NEW TIMES ARCHITECTURE

- the 16<sup>th</sup> Album: THE WORLD'S ARCHITECTURE OF THE 1870's
- the 17<sup>th</sup> Album: THE WORLD'S ARCHITECTURE OF THE 1880's
- the 18<sup>th</sup> Album: THE WORLD'S ARCHITECTURE OF THE 1890's
- the 19<sup>th</sup> Album: THE WORLD'S ARCHITECTURE OF THE 1900's
- the 20<sup>th</sup> Album: THE WORLD'S ARCHITECTURE OF THE 1910's
- the 21<sup>st</sup> Album: THE WORLD'S ARCHITECTURE OF THE 1920's
- the 22<sup>nd</sup> Album: THE WORLD'S ARCHITECTURE OF THE 1930's
- the 23<sup>rd</sup> Album: THE WORLD'S ARCHITECTURE OF THE 1940's
- the 24<sup>th</sup> Album: THE WORLD'S ARCHITECTURE OF THE 1950's
- the 25<sup>th</sup> Album: THE WORLD'S ARCHITECTURE OF THE 1960's
- the 26<sup>th</sup> Album: THE WORLD'S ARCHITECTURE OF THE 1970's
- the 27<sup>th</sup> Album: THE WORLD'S ARCHITECTURE OF THE 1980's
- the 28<sup>th</sup> Album: THE WORLD'S ARCHITECTURE OF THE 1990's
- the 29<sup>th</sup> Album: THE WORLD'S ARCHITECTURE OF THE 2000's
- the 30<sup>th</sup> Album: THE WORLD'S ARCHITECTURE OF THE 2010's

Examples are distributed in chronological order of the construct completion.

**Images sources are indicated directly near with illustrations on each page.**

Architects and companies listed on the basis of aggregate data from different sources (for some objects from various sources indicate different authors). About some buildings listed authors in the available sources has not yet been found.

The Author expresses his gratitude to Internet resources – <https://www.google.com> ; <https://www.wikipedia.org> – which to provide the ability to collect an information.

*The 3<sup>rd</sup> Album's front cover:*

**The Djoser's Pyramid, Saqqara necropolis, Egypt, 27<sup>th</sup> century BC (Arch. Imhotep) -**

<http://1chudo.ru/images/materials/39pirheops/4.jpg>

**The Great Pyramid (the Khufu's Pyramid or the Pyramid of Cheops), Giza's pyramid complex, Egypt, 2560 BC (Arch. Hemon / Hemiunu) -** [http://3.bp.blogspot.com/-8QLWd4gCJ8A/Ve\\_sLhBXxbl/AAAAAAAAAK4/4dpG-eAebA0/s1600/Giza.jpg](http://3.bp.blogspot.com/-8QLWd4gCJ8A/Ve_sLhBXxbl/AAAAAAAAAK4/4dpG-eAebA0/s1600/Giza.jpg)

**The Karnak Temple complex, Thebes, Egypt, from Middle Kingdom to Ptolemaic Kingdom -**

[https://oi.uchicago.edu/sites/oi.uchicago.edu/files/uploads/shared/images/archive/epi/khonsu\\_temple.jpg](https://oi.uchicago.edu/sites/oi.uchicago.edu/files/uploads/shared/images/archive/epi/khonsu_temple.jpg)

**The Akhetaton town, Egypt, 1346 - 1332 BC -** <http://townevolution.ru/books/item/f00/s00/z0000021/pic/000017.jpg>

### **Purpose of the 3<sup>rd</sup> Lecture:**

To study the basic features of the Egypt Architecture in the Ancient period.

### **Tasks of the 3<sup>rd</sup> Lecture:**

- To consider characteristic examples of specifically organized spaces and buildings;
- To accentuate the features of construction depending on the availability of building materials;
- To emphasize the difference between cult and dwelling buildings.

### **Tasks for the self-research work:**

1. Study the change in the nomenclature of buildings and structures during the evolution of the architecture of Ancient Egypt
2. Analyze geometric parameters of main types of structures and buildings.

### **Questions for the self-preparation:**

1. What is the structure of the pyramid's temple complex in the period of the Ancient and Middle Kingdoms?
2. What is the structure of a typical temple complex of the New Kingdom period?

### **Themes of abstracts (16 pages, 40 000 characters, A4 format):**

1. The evolution of the Architecture in the Old Kingdom period
2. The evolution of the Architecture in the Middle Kingdom period
3. The evolution of the Architecture in the New Kingdom period

## **Examples for the 3<sup>rd</sup> Lecture:**

- 3.1** The Ancient Egypt: Geographical position and Time-Line
- 3.2** The Djoser's Pyramid, Saqqara necropolis, Egypt, 27th century BC (Arch. Imhotep)
- 3.3** The Huni's pyramid / the Sneferu's pyramid (the Pseudo Pyramid), Meidum, 2680 BC; The Bent Pyramid, Dahshur necropolis, ~ 2660 BC; The Red pyramid / the North Pyramid, Dahshur necropolis (2640 - 2620 BC), Egypt
- 3.4** The Great Pyramid (the Khufu's Pyramid or the Pyramid of Cheops), Giza's pyramid complex, Egypt, 2560 BC (Arch. Hemon / Hemiunu)
- 3.5** The Senusret III's pyramid (Lepsius XLVII's pyramid), 19th century BC; The "Black Pyramid" (Amenemhat III's pyramid or "Amenemhet The Mighty"), 1860–1814 BC, Dahshur necropolis, Egypt
- 3.6** The Nebhepetre Mentuhotep II's mortuary temple (~2061 - 1995 BC) and Hatshepsut mortuary temple, Deir el-Bahri, Egypt, 1482 - 1473 BC (Arch. Senenmut)
- 3.7** The Luxor Temple complex, Thebes, Egypt, ~ 1400 BC
- 3.8** The Karnak Temple complex, Thebes, Egypt, from Middle Kingdom to Ptolemaic Kingdom
- 3.9** The Akhetaton town, Egypt, 1346 - 1332 BC
- 3.10** The Ramses II's temple, Abu Simbel, Egypt, 1st half of the 13th century BC

### 3.1 The Ancient Egypt: Geographical position and Time-Line

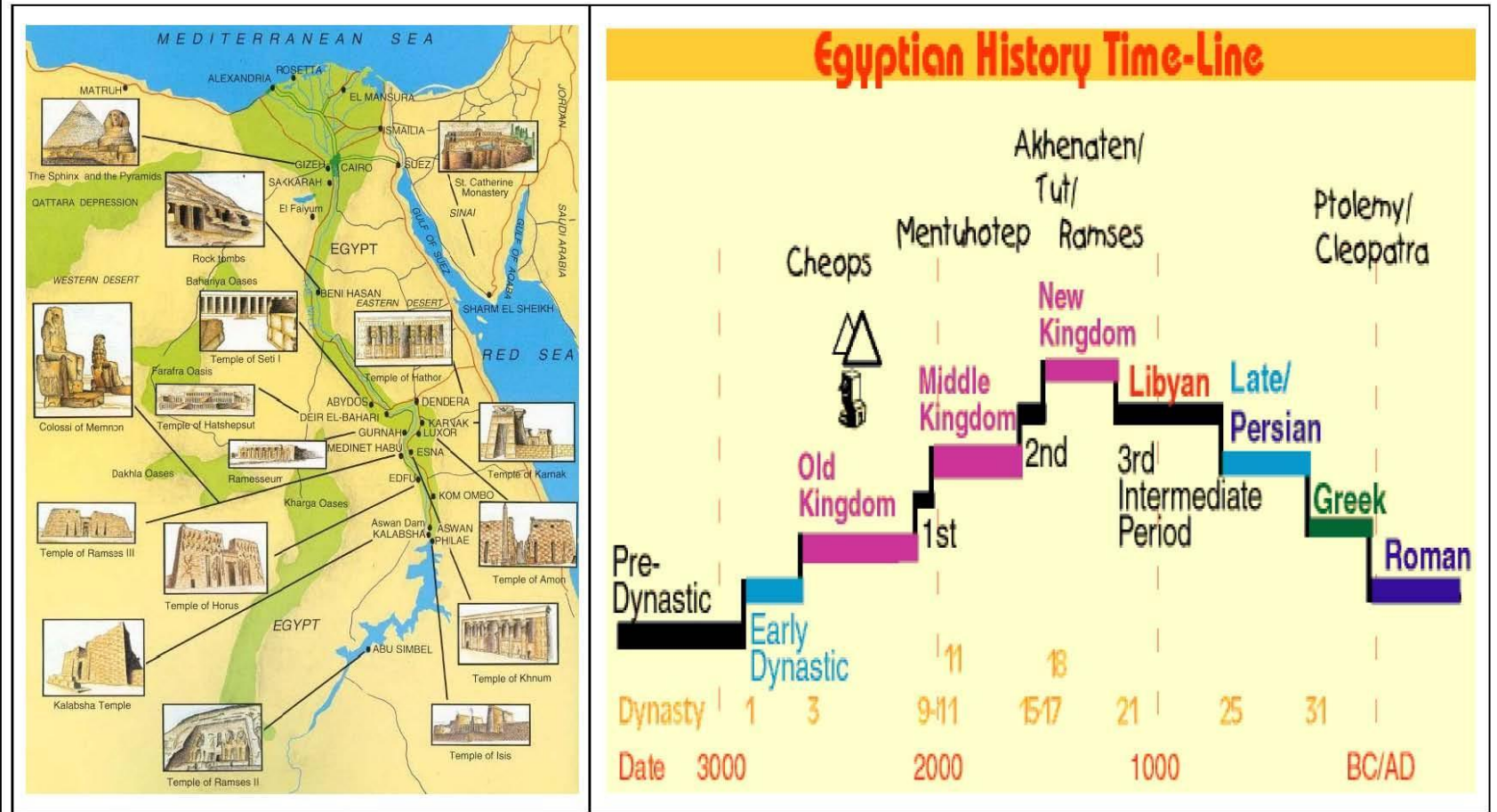

Sources: <https://s-media-cache-ak0.pinimg.com/736x/83/23/9a/83239a6637d007e8a67818b865e154c1.jpg>; [https://mevnu.files.wordpress.com/2012/03/egypt\\_time-line2.gif](https://mevnu.files.wordpress.com/2012/03/egypt_time-line2.gif)

### 3.2 The Djoser's Pyramid, Saqqara necropolis, Egypt, 27<sup>th</sup> century BC (Arch. Imhotep)

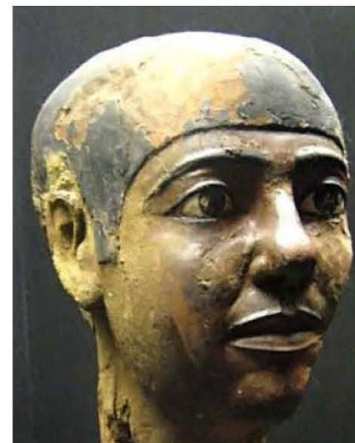
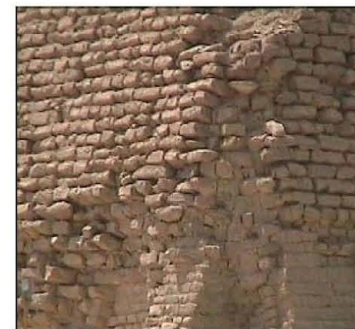
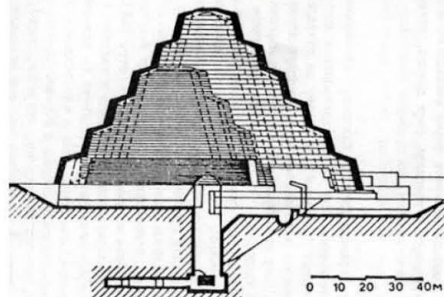
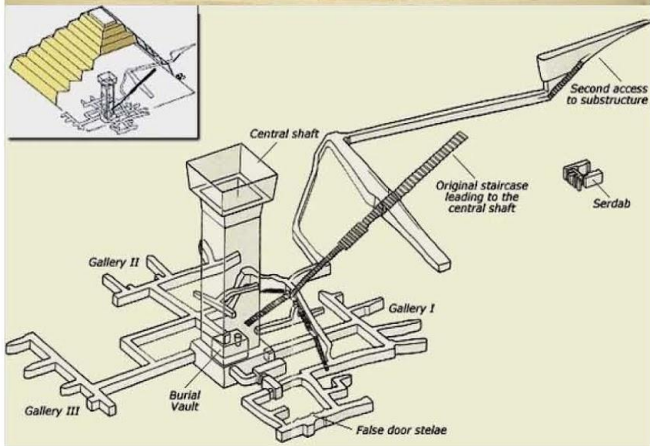
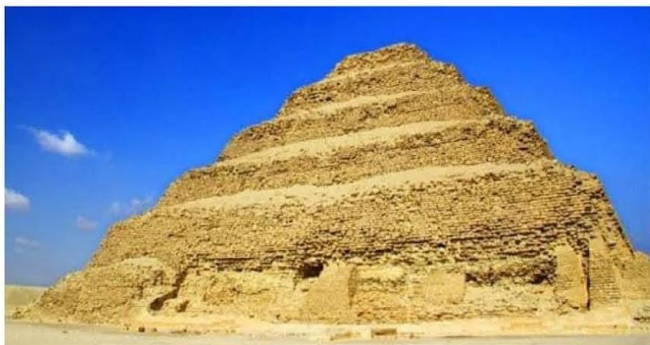

Sources: <http://1chudo.ru/images/materials/39pirheops/4.jpg> ; <http://content.foto.mail.ru/mail/kle.alex/ blogs/i-2998.jpg> ; [http://nomarh.narod.ru/pir\\_diosera.bmp](http://nomarh.narod.ru/pir_diosera.bmp) ; <http://www.ancient-origins.net/sites/default/files/styles/large/public/Alley-of-cobras-in-front-of-Saqqara-step-pyramid.jpg?itok=YmQXZBNw> ; <https://probaway.files.wordpress.com/2008/07/imhotep-djoser-pyramid.jpg> ; <http://www.ancient-wisdom.com/images/countries/Egyptian%20pics/pyramidbricks4.jpg> ; [http://www.pechenkin.ru/piramids\\_1kniga.files/image004.jpg](http://www.pechenkin.ru/piramids_1kniga.files/image004.jpg) ; <http://chert-poberi.ru/wp-content/uploads/2016/proqa/111/iqor-13april1619325732.jpg>



### 3.3 The Huni's pyramid / the Sneferu's pyramid (the Pseudo Pyramid), Meidum, 2680 BC; The Bent Pyramid, Dahshur necropolis, ~ 2660 BC; The Red pyramid / the North Pyramid, Dahshur necropolis (2640 - 2620 BC), Egypt

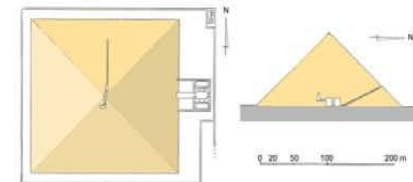
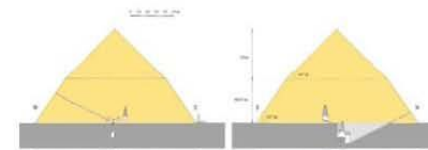
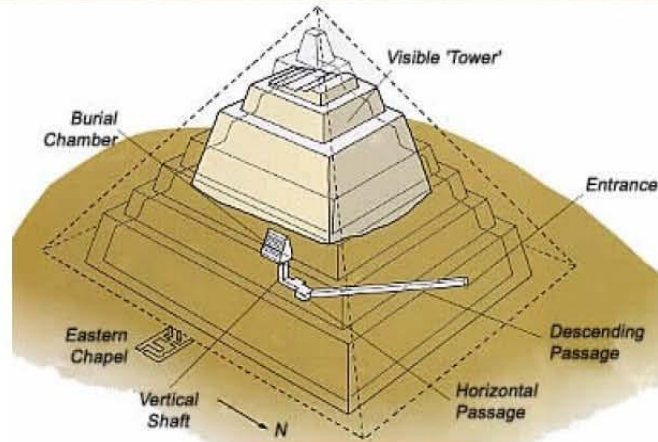

Sources: <http://turizm.world/wp-content/uploads/2015/12/pyramid-meidum-egypt.jpg> ; <http://3.bp.blogspot.com/-b3nj3mH2Hzc/VbJ9xgLoYC/AAAAAAAAU4/zdnZUoatp10/s1600/8.jpg> ; <http://www.travelgeni.com/wp-content/uploads/2015/03/egypt-sneferu-bent-pyramid.jpg> ; [https://upload.wikimedia.org/wikipedia/commons/5/57/Bent\\_Pyramid\\_substructure\\_2.png](https://upload.wikimedia.org/wikipedia/commons/5/57/Bent_Pyramid_substructure_2.png) ; [http://s3.drugiegoroda.ru/2/205/20513-Red\\_Pyramid\\_plan.png](http://s3.drugiegoroda.ru/2/205/20513-Red_Pyramid_plan.png) ; <http://stranic.ru/wp-content/uploads/2012/06/red-pyramid2.jpg>

### 3.4 The Great Pyramid (the Khufu's Pyramid or the Pyramid of Cheops), Giza's pyramid complex, Egypt, 2560 BC (Arch. Hemon / Hemiunu)

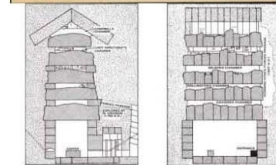
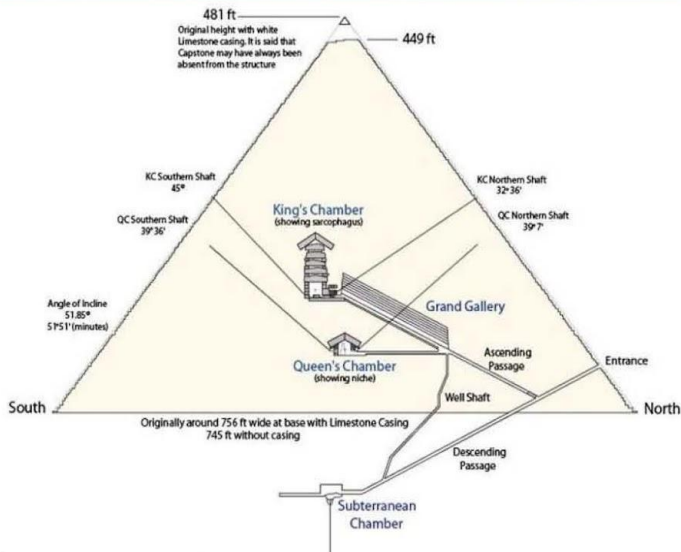
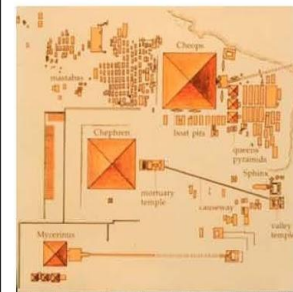

Sources: [http://3.bp.blogspot.com/-8QLWd4qCJ8A/Ve\\_sLhBXxbI/AAAAAAAAAK4/4dpG-eAebA0/s1600/Giza.jpg](http://3.bp.blogspot.com/-8QLWd4qCJ8A/Ve_sLhBXxbI/AAAAAAAAAK4/4dpG-eAebA0/s1600/Giza.jpg); <http://www.studyofoahspe.com/sitebuildercontent/sitebuilderpictures/Diagram-Great-Pyramid.jpg>; <http://www.thehistoryhub.com/wp-content/uploads/2014/10/Pyramid-of-Giza-Entrance.jpg>; [https://www.courses.psu.edu/art\\_h/art\\_h201\\_ejw3/plan.jpg](https://www.courses.psu.edu/art_h/art_h201_ejw3/plan.jpg); <http://godstimecapsule.com/wp-content/uploads/2012/03/Screen-Shot-2014-11-10-at-12.18.50-PM-1.jpg>; [https://archaeologyatrandom.files.wordpress.com/2015/09/hemiunu-head\\_med\\_hr.png](https://archaeologyatrandom.files.wordpress.com/2015/09/hemiunu-head_med_hr.png)

### 3.5 The Senusret III's pyramid (Lepsius XLVII's pyramid), 19<sup>th</sup> century BC; The "Black Pyramid" (Amenemhat III's pyramid or "Amenemhet The Mighty"), 1860–1814 BC, Dahshur necropolis, Egypt

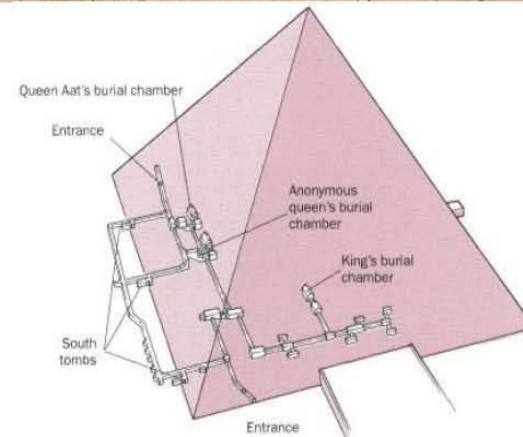
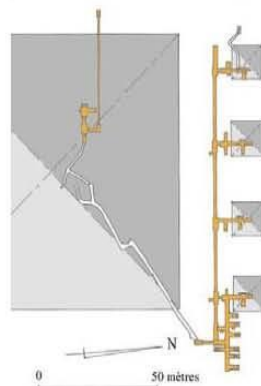
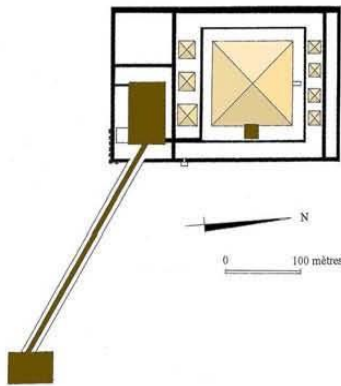

Sources: <http://www.ancientegyptonline.co.uk/images/pyramid-senusertIII.jpg> ; <https://upload.wikimedia.org/wikipedia/commons/thumb/2/2c/Sesostris3-plan-complexe.jpg/800px-Sesostris3-plan-complexe.jpg> ; <https://upload.wikimedia.org/wikipedia/commons/thumb/3/30/Sesostris3-plan-appartements.jpg/800px-Sesostris3-plan-appartements.jpg> ; <http://2.bp.blogspot.com/-H5xuboszPGc/TWDX2vZyrI/AAAAAAAAABhEw/1PxGsYc6gA/s1600/1+B%252C+Dahshur+pyramid+of+Amenemhat+III+bunial+two+queens%252C+egyptian+gods.JPG> ; [http://www.moin-monija.de/egypt/pharaonen/06-mittleres\\_reich/12-dynastie/amenemhet\\_III/pyramiden\\_amenemhet\\_III/dahschur\\_amenemhet\\_III\\_pyramide\\_west.jpg](http://www.moin-monija.de/egypt/pharaonen/06-mittleres_reich/12-dynastie/amenemhet_III/pyramiden_amenemhet_III/dahschur_amenemhet_III_pyramide_west.jpg)

### 3.6 The Nebhepetre Mentuhotep II's mortuary temple (~2061 - 1995 BC) and Hatshepsut mortuary temple, Deir el-Bahri, Egypt, 1482 - 1473 BC (Arch. Senenmut)

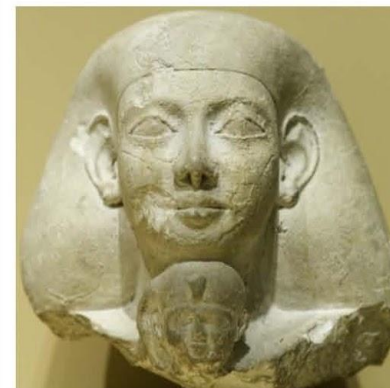
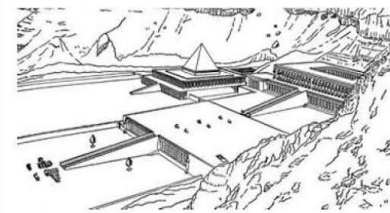
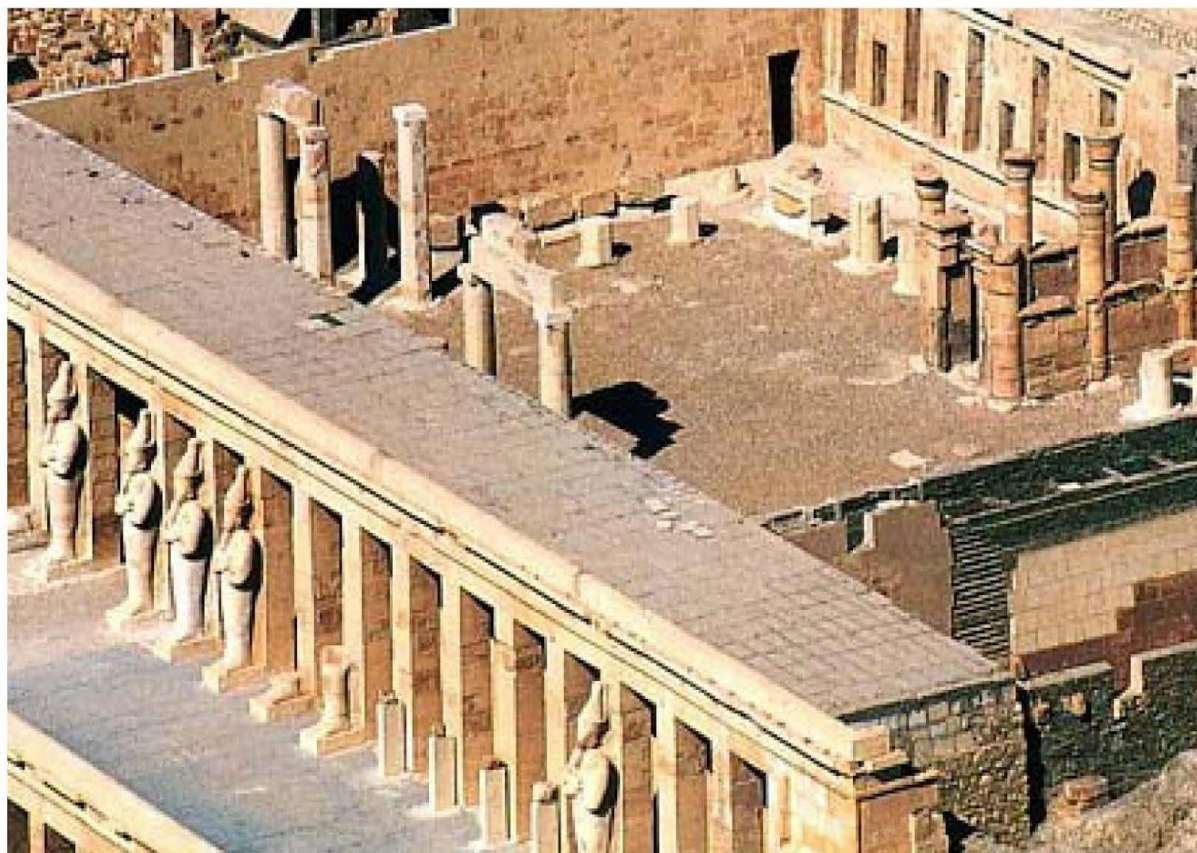

Sources: [http://www.bellabs.ru/Egypt/Luxor/Egypt2011\\_12-0144\\_ThebesBalloon.jpg](http://www.bellabs.ru/Egypt/Luxor/Egypt2011_12-0144_ThebesBalloon.jpg) ; <http://www.royanddaria.com/silverseas/images/417-Hatshepsut%20temple.jpg> ; [http://ok-t.ru/studopedia/baza1/1222365641178\\_files/image048.jpg](http://ok-t.ru/studopedia/baza1/1222365641178_files/image048.jpg) ; <http://egyptfan.ru/wp-content/uploads/2015/07/MqxONbw4IA.jpg> ; [https://c1.staticflickr.com/5/4024/4417516269\\_6e95b377be\\_b.jpg](https://c1.staticflickr.com/5/4024/4417516269_6e95b377be_b.jpg)

### 3.7 The Luxor Temple complex, Thebes, Egypt, ~ 1400 BC

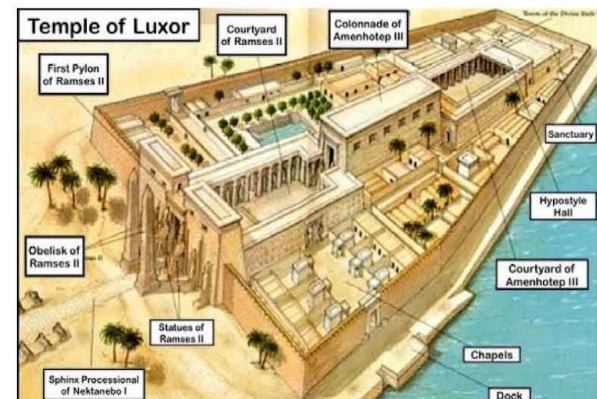

Sources: <http://www.ancientegyptonline.co.uk/images/luxortemple5.jpg> ; <http://www.rideegypt.com/wp-content/uploads/2016/09/temple-of-luxor.jpg> ; <http://www.hightoursegyp.com/photos/egypt/pic/Luxor-Temple/43/0.jpg> ; <http://raredelights.com/wp-content/uploads/2013/09/Luxor-Temple-in-Egypt-8.jpg>

### 3.8 The Karnak Temple complex, Thebes, Egypt, from Middle Kingdom to Ptolemaic Kingdom

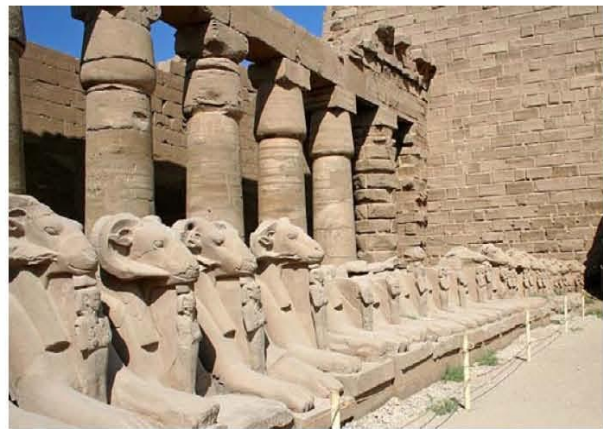
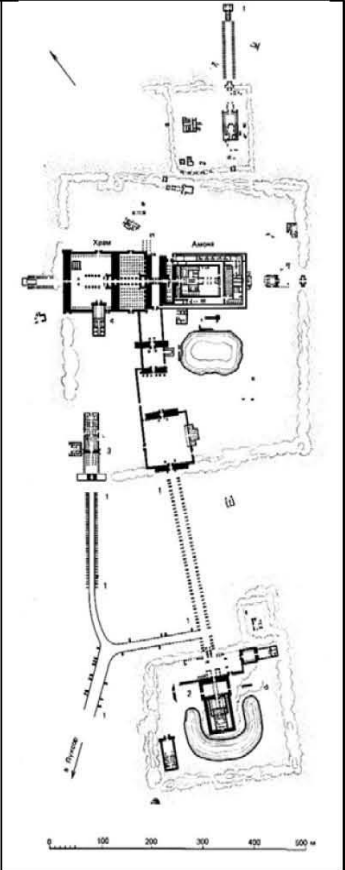

Sources: [https://oi.uchicago.edu/sites/oi.uchicago.edu/files/uploads/shared/images/archive/epi/khonsu\\_temple.jpg](https://oi.uchicago.edu/sites/oi.uchicago.edu/files/uploads/shared/images/archive/epi/khonsu_temple.jpg) ; <http://www.mummies2pyramids.info/pictures/images/karnak-temple-003.jpg> ; <http://st1.ancientfacts.net/wp-content/uploads/2016/03/columns.jpg> ; [http://michel.lalos.free.fr/site\\_egypte/karnak/pln\\_karnak01.jpg](http://michel.lalos.free.fr/site_egypte/karnak/pln_karnak01.jpg) ; <http://www.thetraveleyes.com/wp-content/uploads/2016/06/KARNAK-2.jpg> ; <http://townevolution.ru/books/item/f00/s00/z0000021/pic/000013.jpg>

### 3.9 The Akhetaton town, Egypt, 1346 - 1332 BC

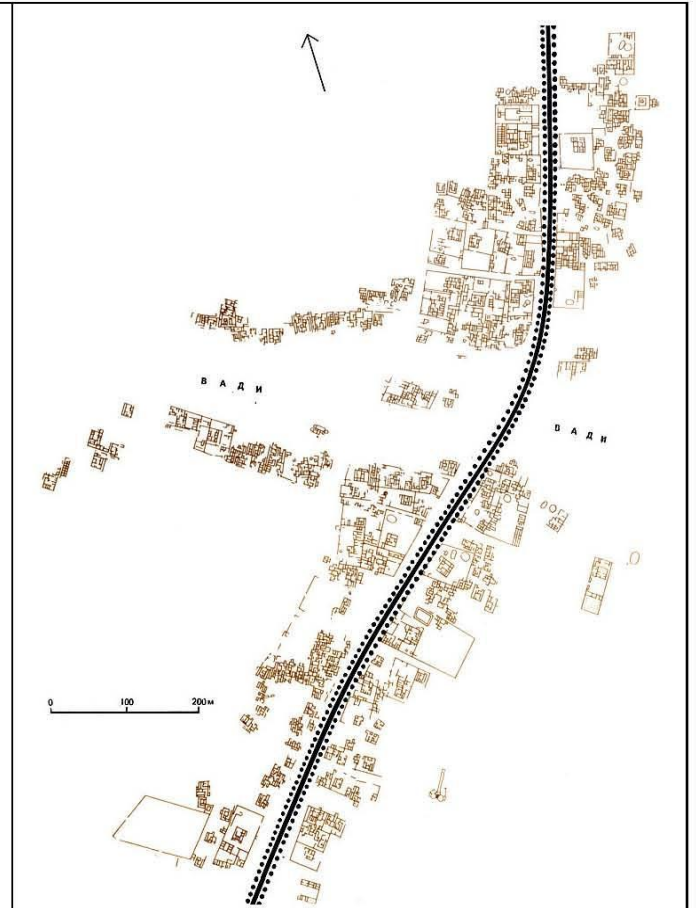
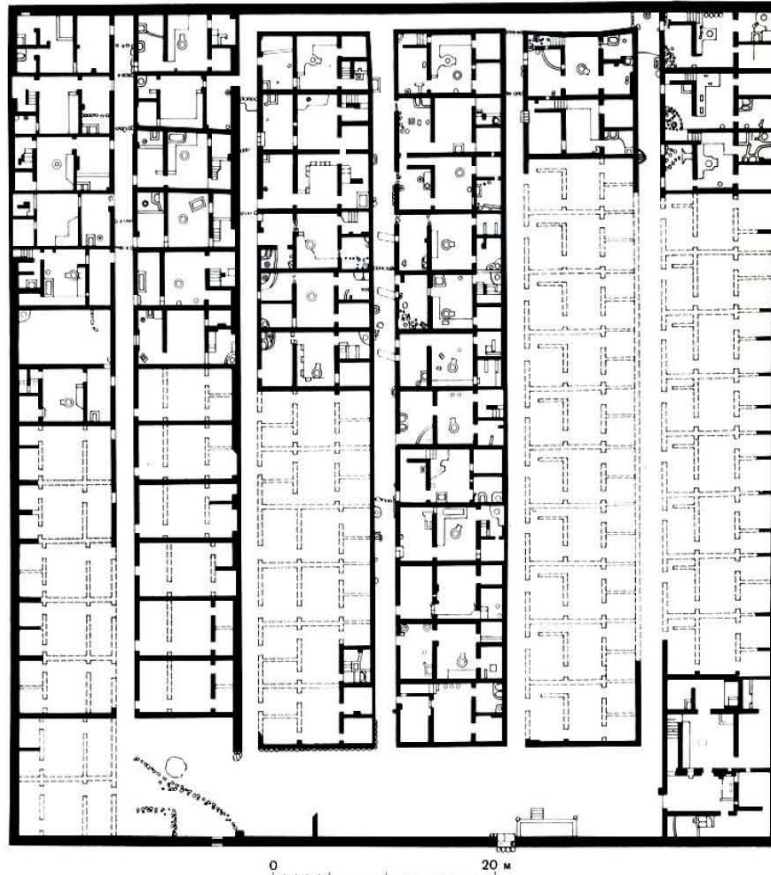

Sources: <http://townevolution.ru/books/item/f00/s00/z0000021/pic/000017.jpg> ; <http://townevolution.ru/books/item/f00/s00/z0000021/pic/000016.jpg>

### 3.10 The Ramses II's temple, Abu Simbel, Egypt, 1<sup>st</sup> half of the 13<sup>th</sup> century BC

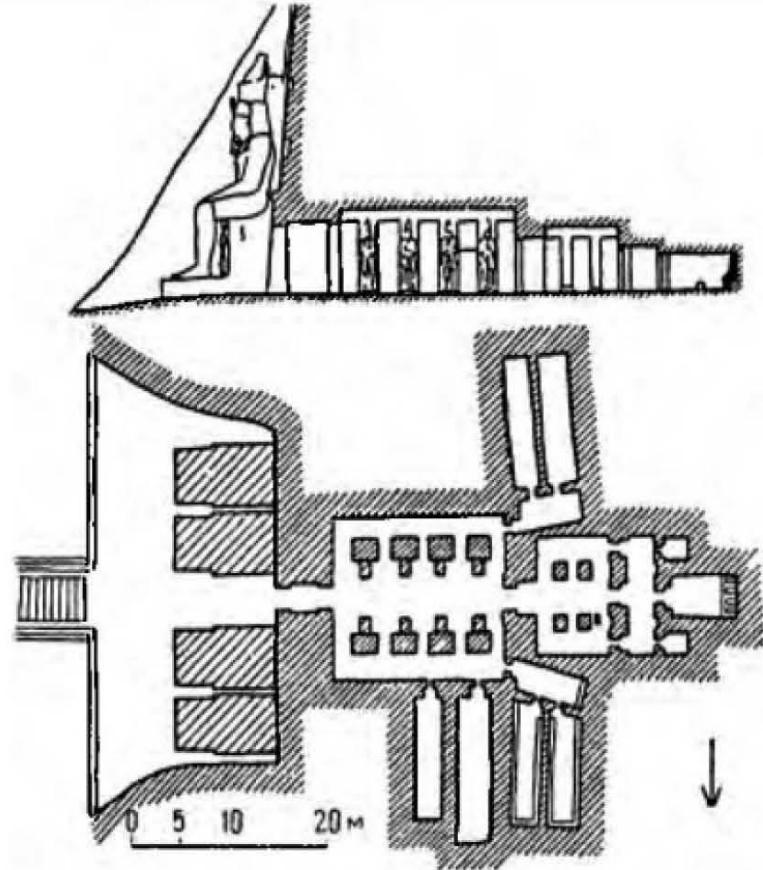
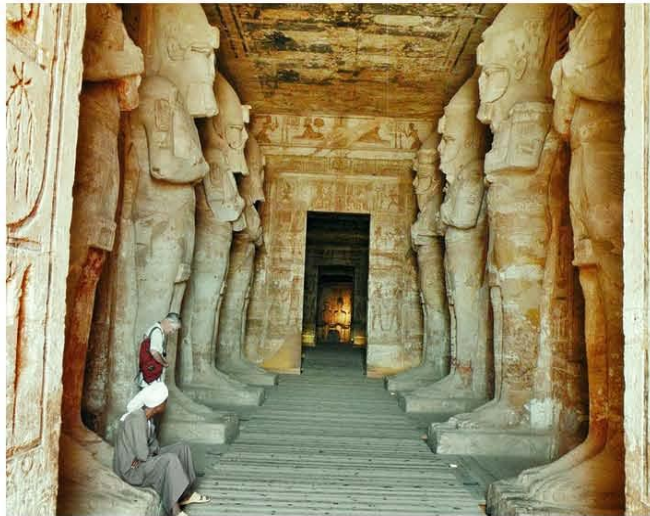

Sources: <http://static.panoramio.com/photos/large/89082497.jpg> ; <http://archisto.info/images/tom-1-39-ris-110c.jpg> ; [https://wiki-turizm.ru/cache/multithumb\\_mob/thumb/uploads/countries/egypt/sz787358\\_sz\\_egypt\\_abu2.jpg](https://wiki-turizm.ru/cache/multithumb_mob/thumb/uploads/countries/egypt/sz787358_sz_egypt_abu2.jpg)



## Recommended educational and scientific-theoretical sources:

1. Great Pyramid of Giza / From Wikipedia, the free encyclopedia. - URL: [https://en.wikipedia.org/wiki/Great\\_Pyramid\\_of\\_Giza](https://en.wikipedia.org/wiki/Great_Pyramid_of_Giza)
2. Pyramid of Djoser / From Wikipedia, the free encyclopedia. - URL: [https://en.wikipedia.org/wiki/Pyramid\\_of\\_Djoser](https://en.wikipedia.org/wiki/Pyramid_of_Djoser)
3. Red Pyramid / From Wikipedia, the free encyclopedia. - URL: [https://en.wikipedia.org/wiki/Red\\_Pyramid](https://en.wikipedia.org/wiki/Red_Pyramid)
4. Meidum / From Wikipedia, the free encyclopedia. - URL: <https://en.wikipedia.org/wiki/Meidum>
5. Pyramid of Amenemhat III (Dahshur) / From Wikipedia, the free encyclopedia. - URL: [https://en.wikipedia.org/wiki/Pyramid\\_of\\_Amenemhat\\_III\\_\(Dahshur\)](https://en.wikipedia.org/wiki/Pyramid_of_Amenemhat_III_(Dahshur))
6. Pyramid of Senusret III / From Wikipedia, the free encyclopedia. - URL: [https://en.wikipedia.org/wiki/Pyramid\\_of\\_Senusret\\_III](https://en.wikipedia.org/wiki/Pyramid_of_Senusret_III)
7. Mortuary Temple of Hatshepsut / From Wikipedia, the free encyclopedia. - URL: [https://en.wikipedia.org/wiki/Mortuary\\_Temple\\_of\\_Hatshepsut](https://en.wikipedia.org/wiki/Mortuary_Temple_of_Hatshepsut)
8. Luxor Temple / From Wikipedia, the free encyclopedia. - URL: [https://en.wikipedia.org/wiki/Luxor\\_Temple](https://en.wikipedia.org/wiki/Luxor_Temple)
9. Karnak / From Wikipedia, the free encyclopedia. - URL: <https://en.wikipedia.org/wiki/Karnak>
10. Karnak: Temple Complex of Ancient Egypt / By Owen Jarus. - November 30, 2012. - <http://www.livescience.com/25184-karnak-temple.html>
11. Египет. - URL: <http://townevolution.ru/books/item/f00/s00/z0000021/st003.shtml>
12. Abu Simbel temples / From Wikipedia, the free encyclopedia. - URL: [https://en.wikipedia.org/wiki/Abu\\_Simbel\\_temples](https://en.wikipedia.org/wiki/Abu_Simbel_temples)

## Briefly about the Author



# Konstantin I. SAMOILOV

High Doctorate (Arch) – 2008,  
Doctor of Sciences (Arch) – 2004,  
Candidate of Sciences / eq. PhD(Arch) – 1990,  
Dipl. Arch. / eq. MArch – 1983,  
Dipl. Tech. Arch. / eq. BArch – 1977



**Associate Professor of the Architectural Faculty –**  
Kazakh Leading Academy of Architecture and Civil Engineering –  
**[www.kazqasa.kz](http://www.kazqasa.kz)**

E: [samconiv@yahoo.com](mailto:samconiv@yahoo.com) , [samconiv@mail.ru](mailto:samconiv@mail.ru)

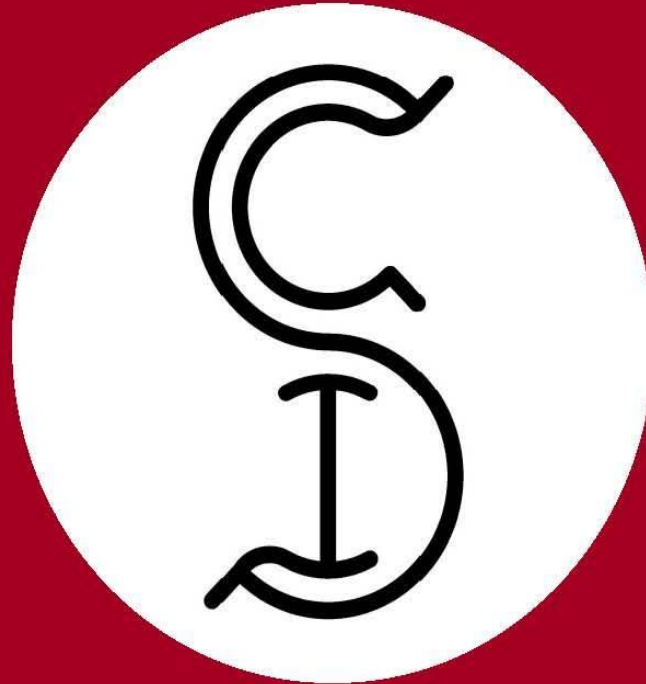

THE HISTORY OF ARCHITECTURE FROM PREHISTORIC TO MODERN TIMES:  
Albums of characteristic examples for the Educational course / by Dr. Konstantin I.Samoilov. –  
The third Album: THE ANCIENT EGYPT'S ARCHITECTURE. – Almaty, 2017. – 18 p.