

$5-4=$

Попробуй еще раз!!!

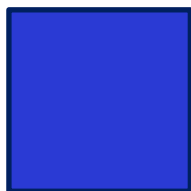
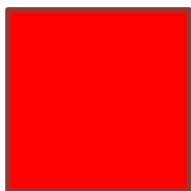
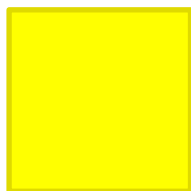
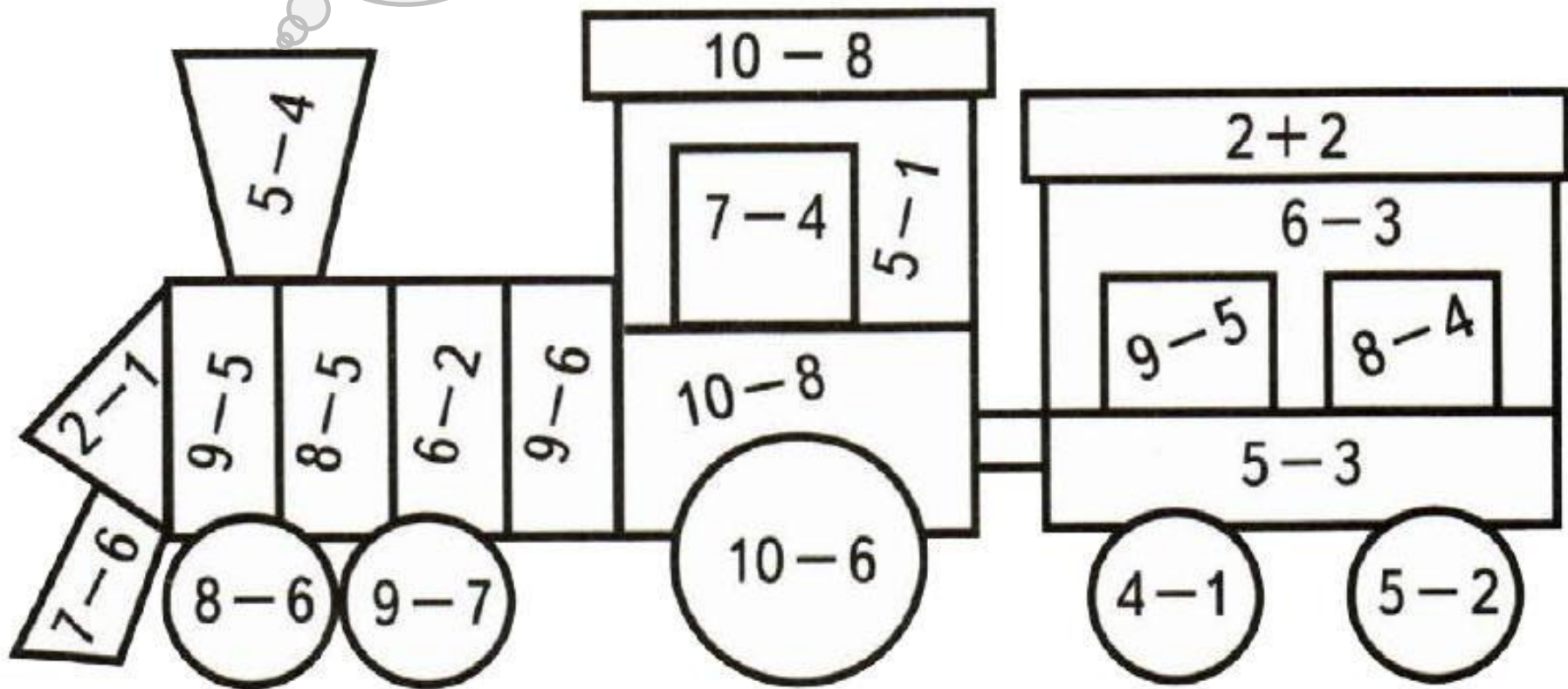

$9-5=$

Попробуй еще раз!!!

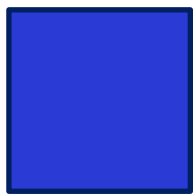
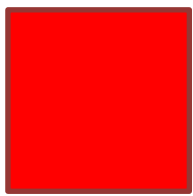
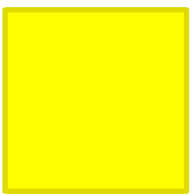
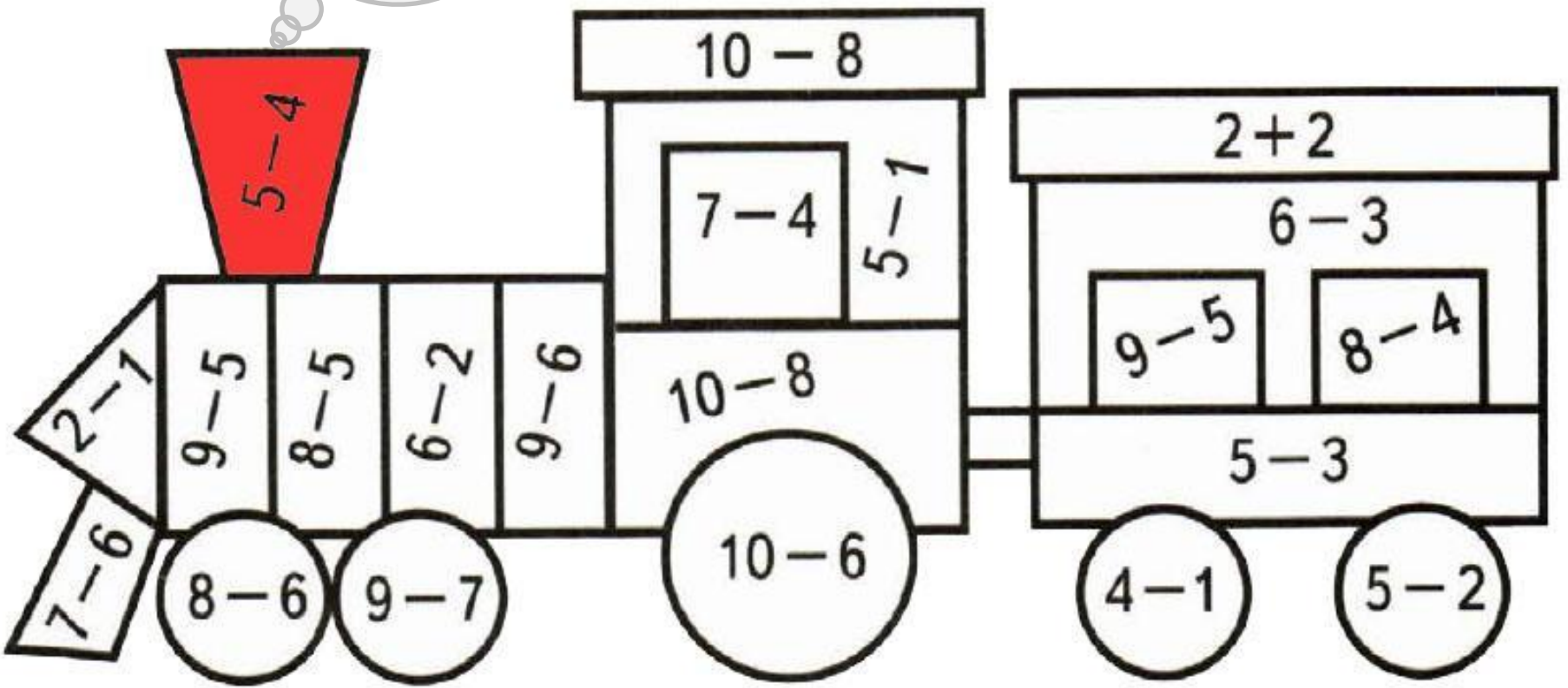

$8-6=$

Попробуй еще раз!!!

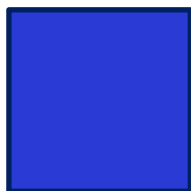
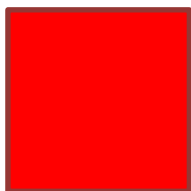
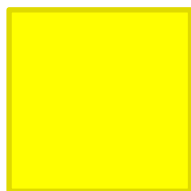
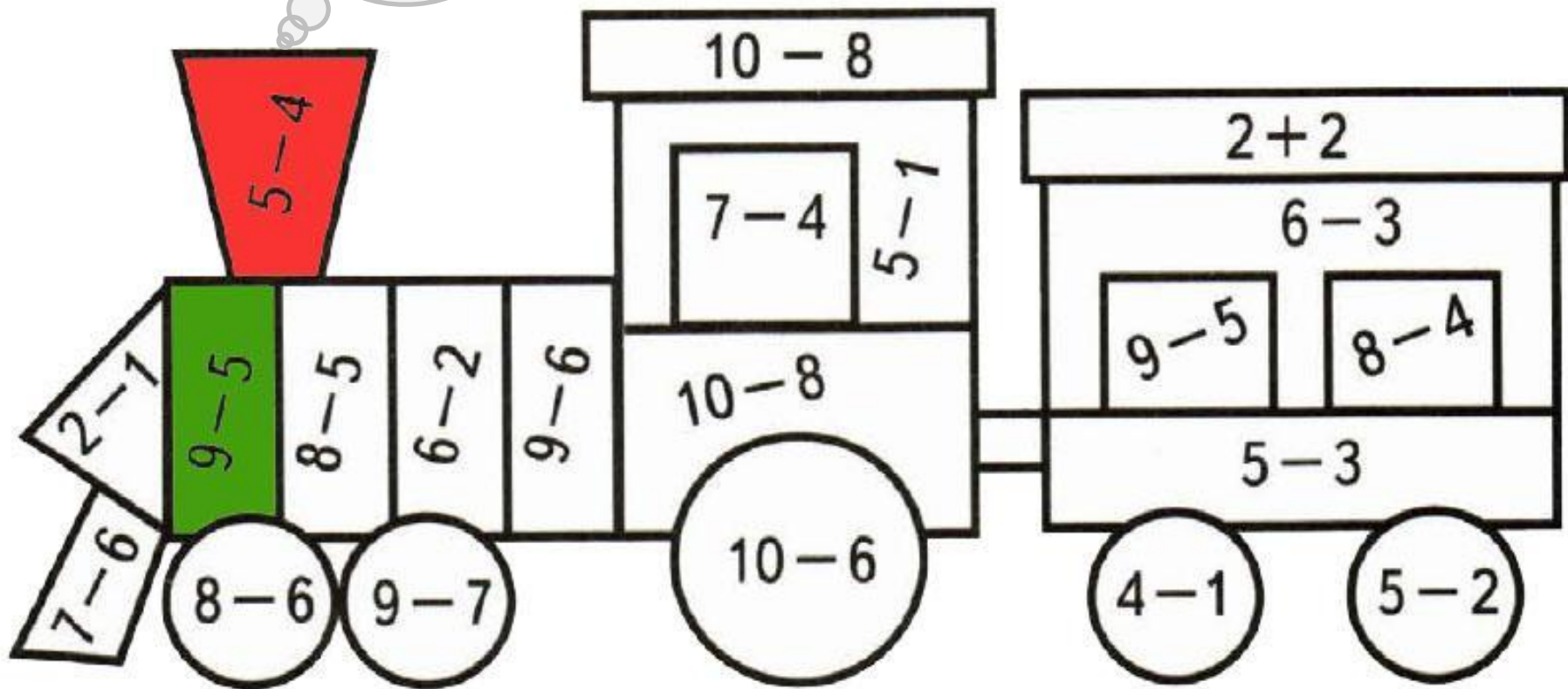

$7-4=$

Попробуй еще раз!!!

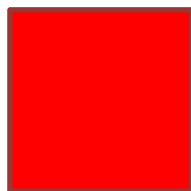
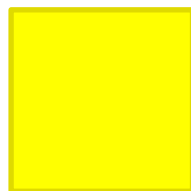
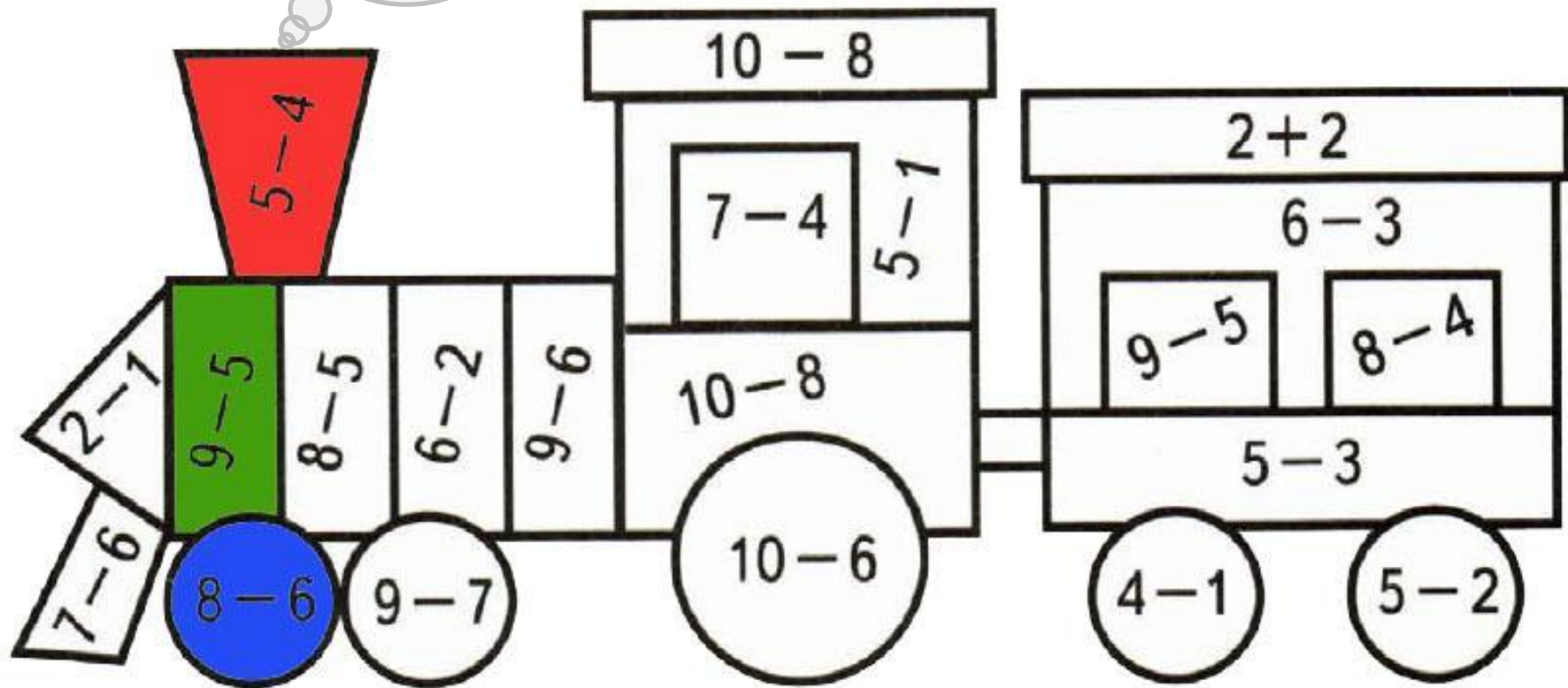

$2-1=$

Попробуй еще раз!!!

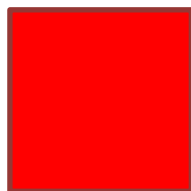
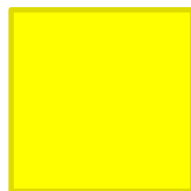
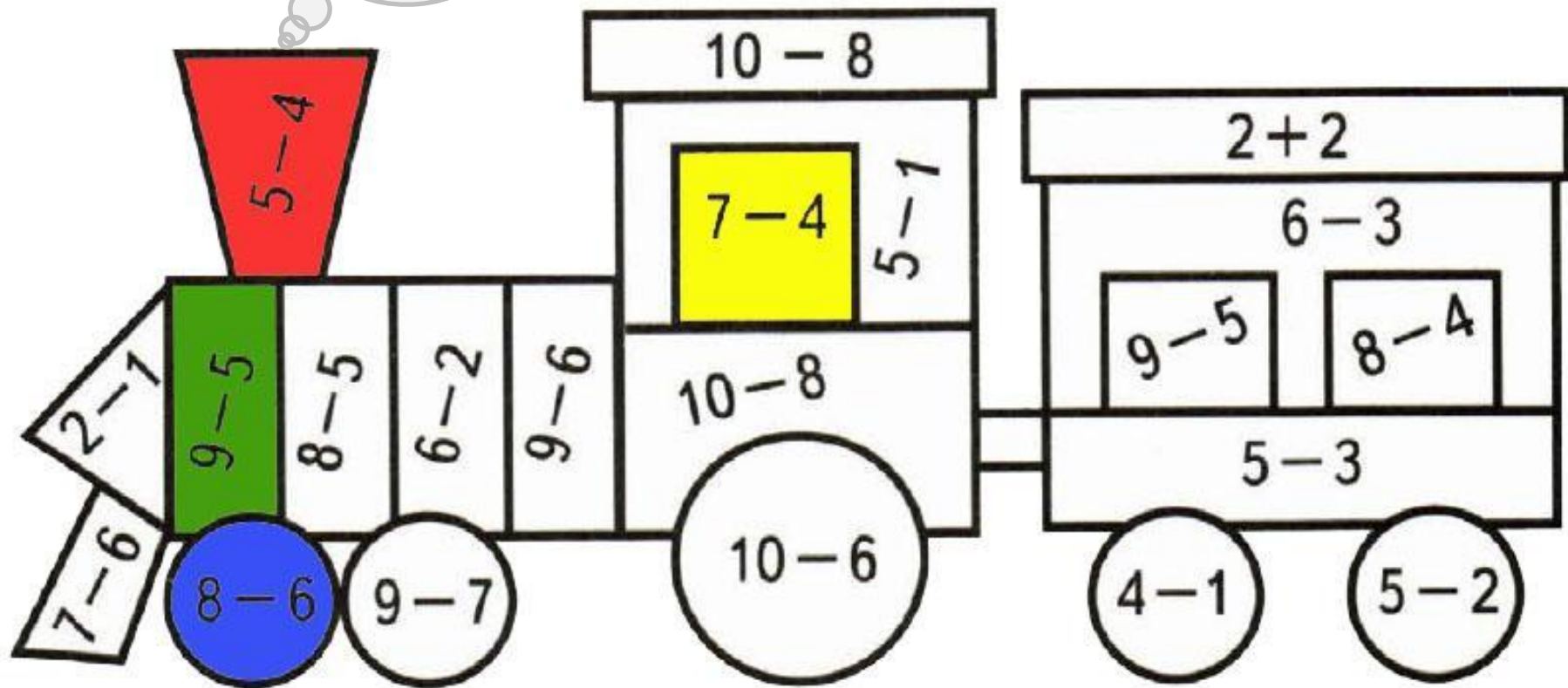

$8-5=$

Попробуй еще раз!!!

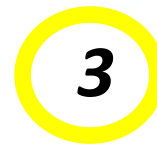
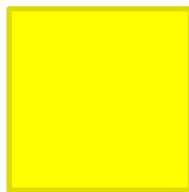
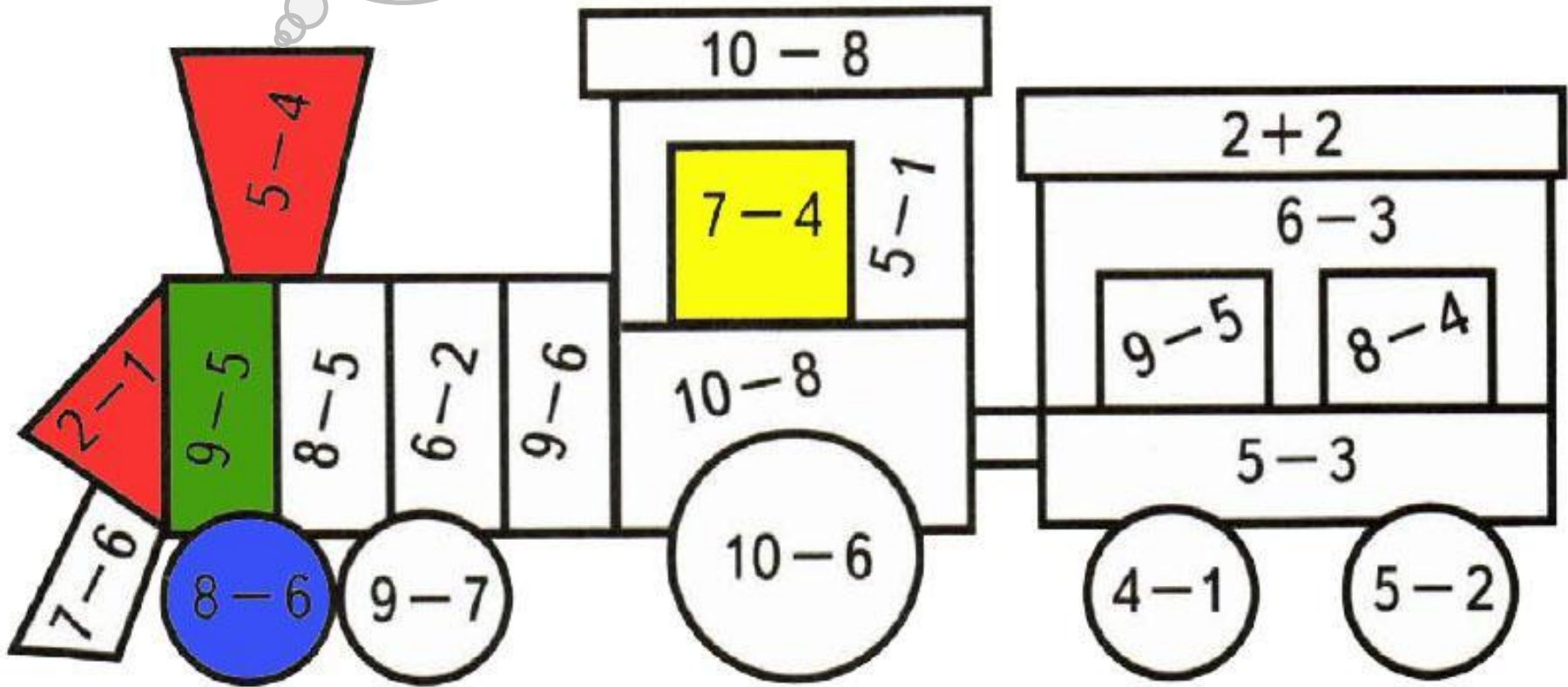

$7-6=$

Попробуй еще раз!!!

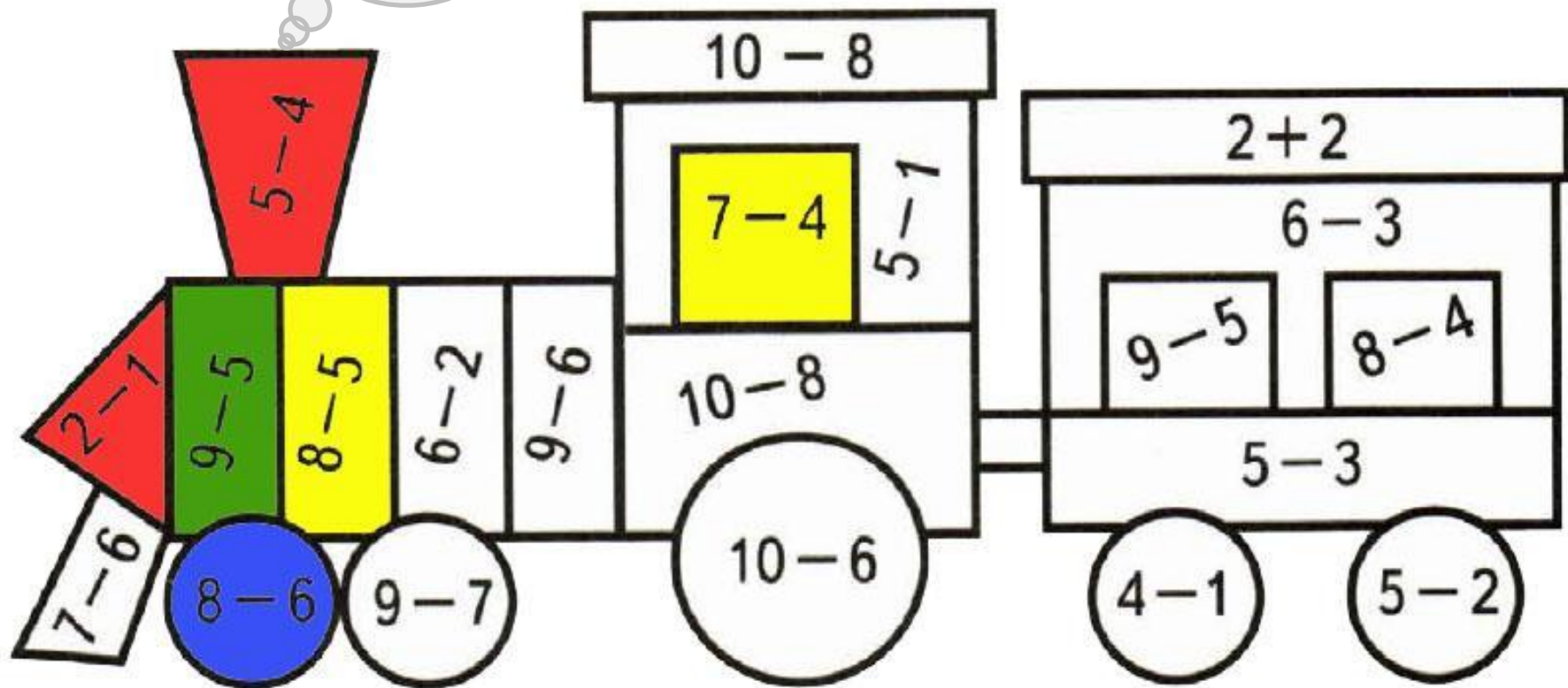

$9-7=$

Попробуй еще раз!!!

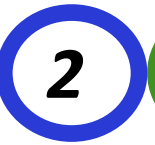
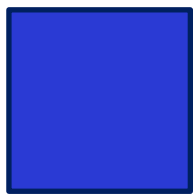
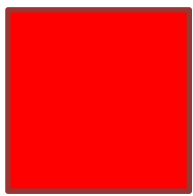
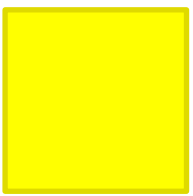
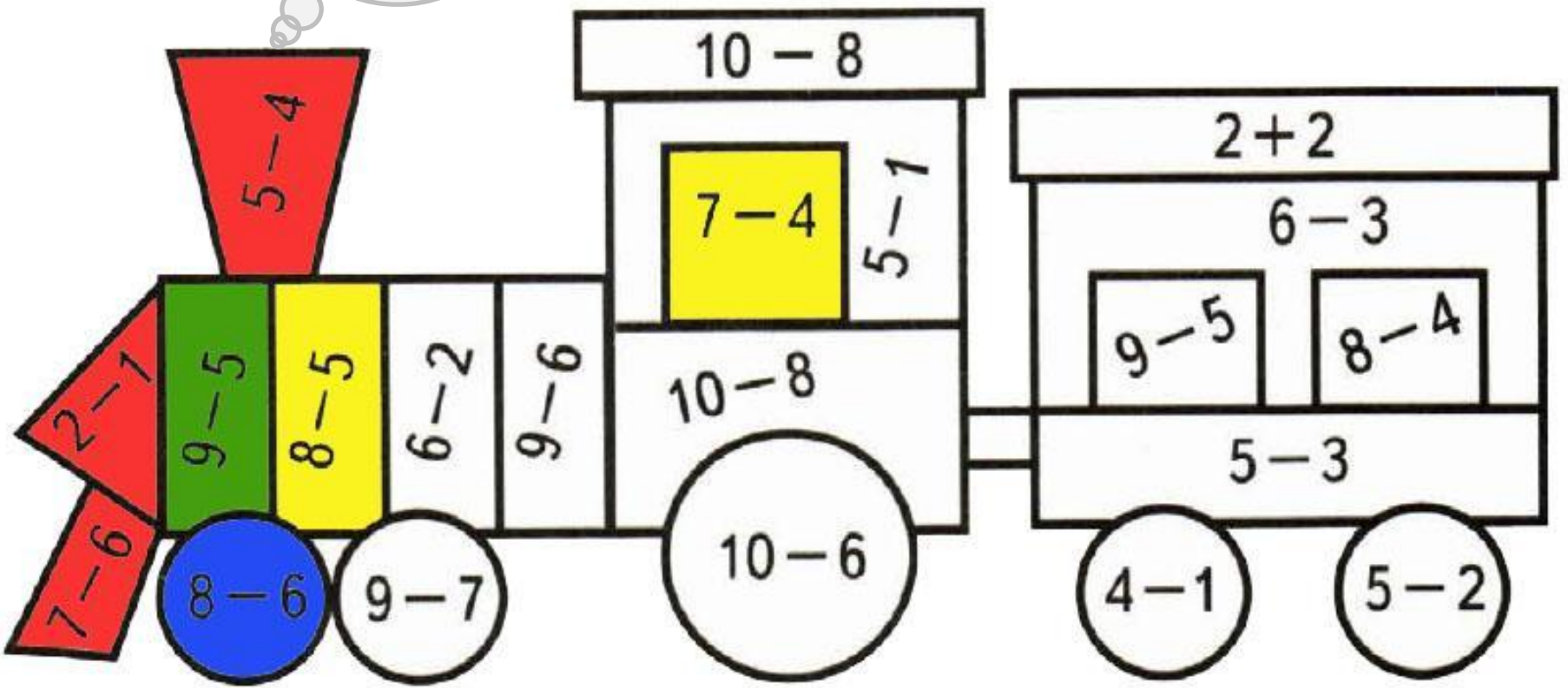

$6-2=$

Попробуй еще раз!!!

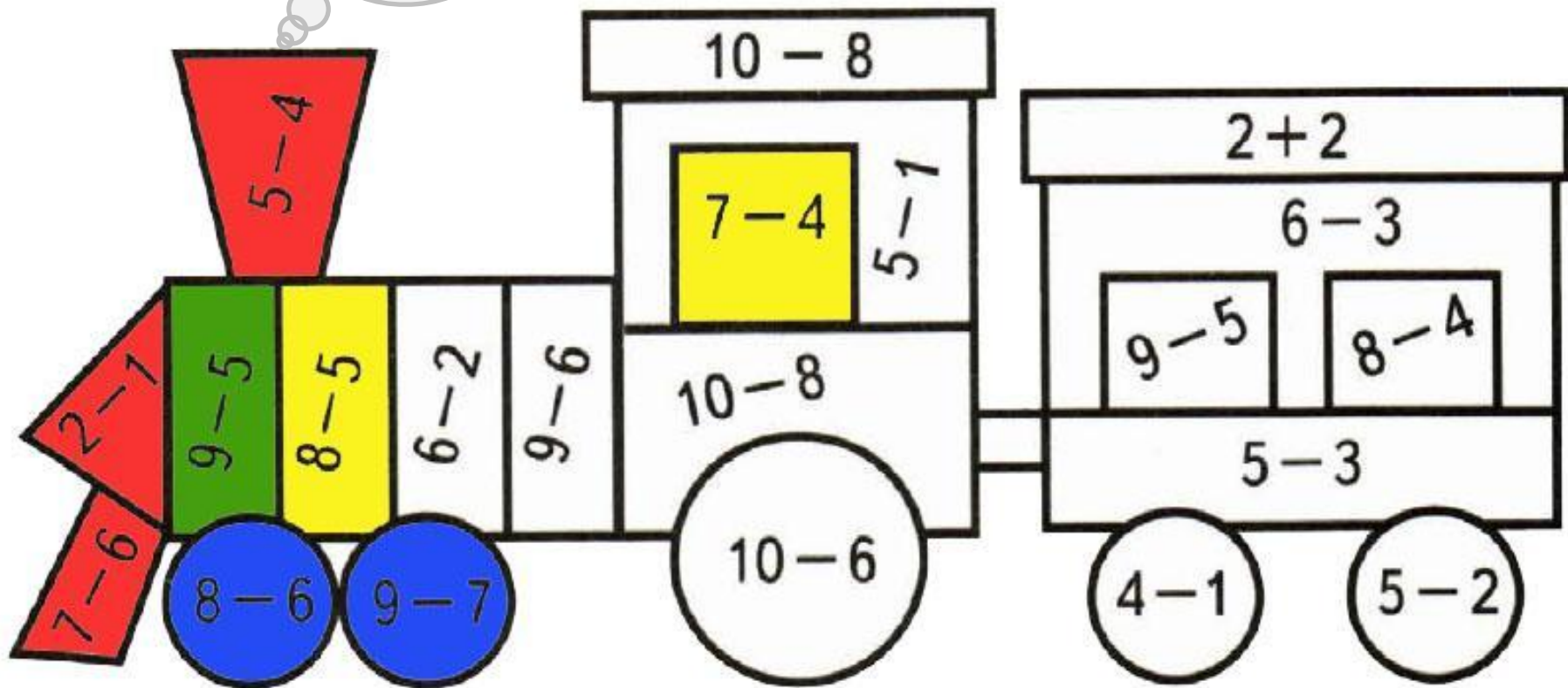

$9-6=$

Попробуй еще раз!!!

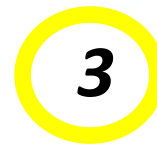
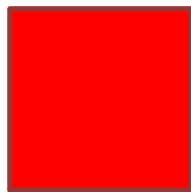
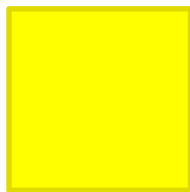
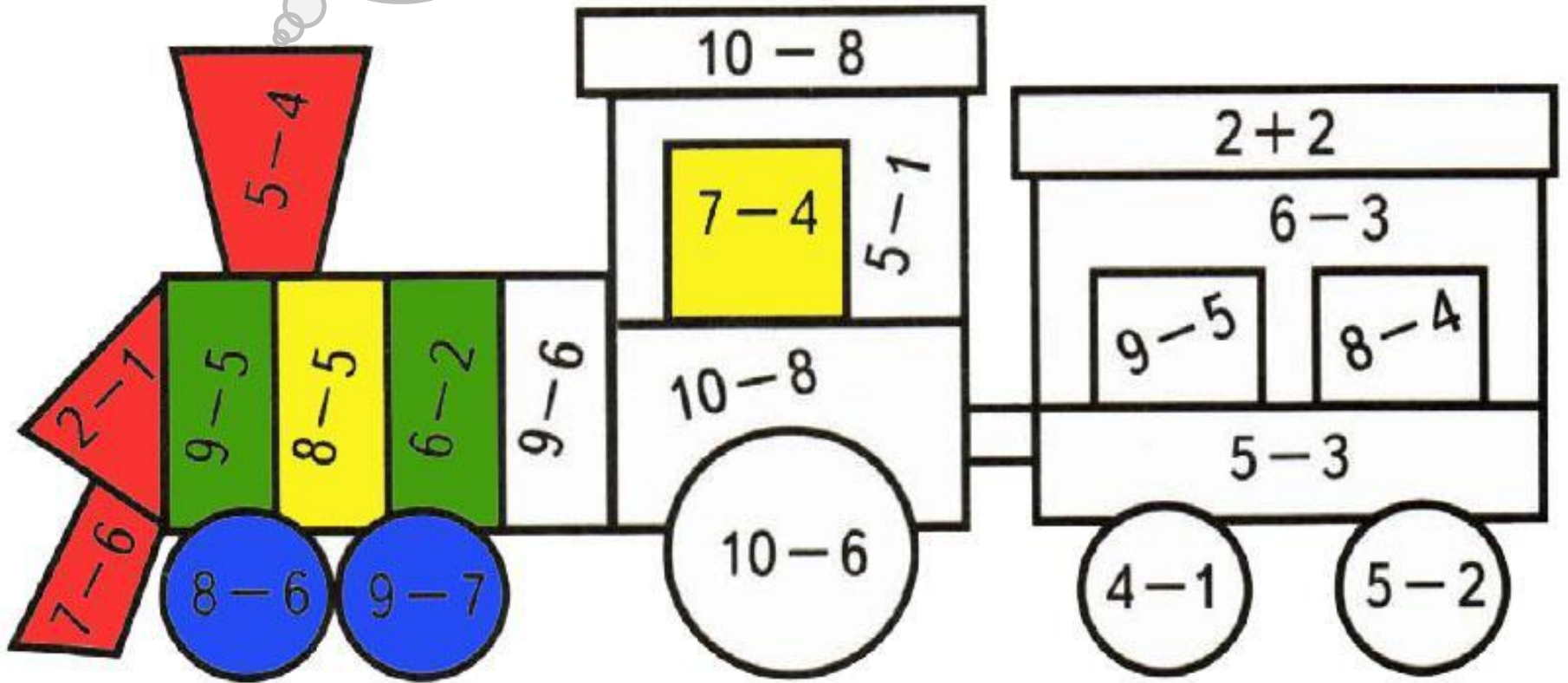

$10-8=$

Попробуй еще раз!!!

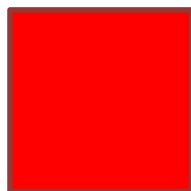
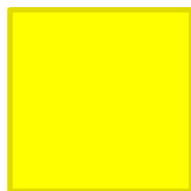
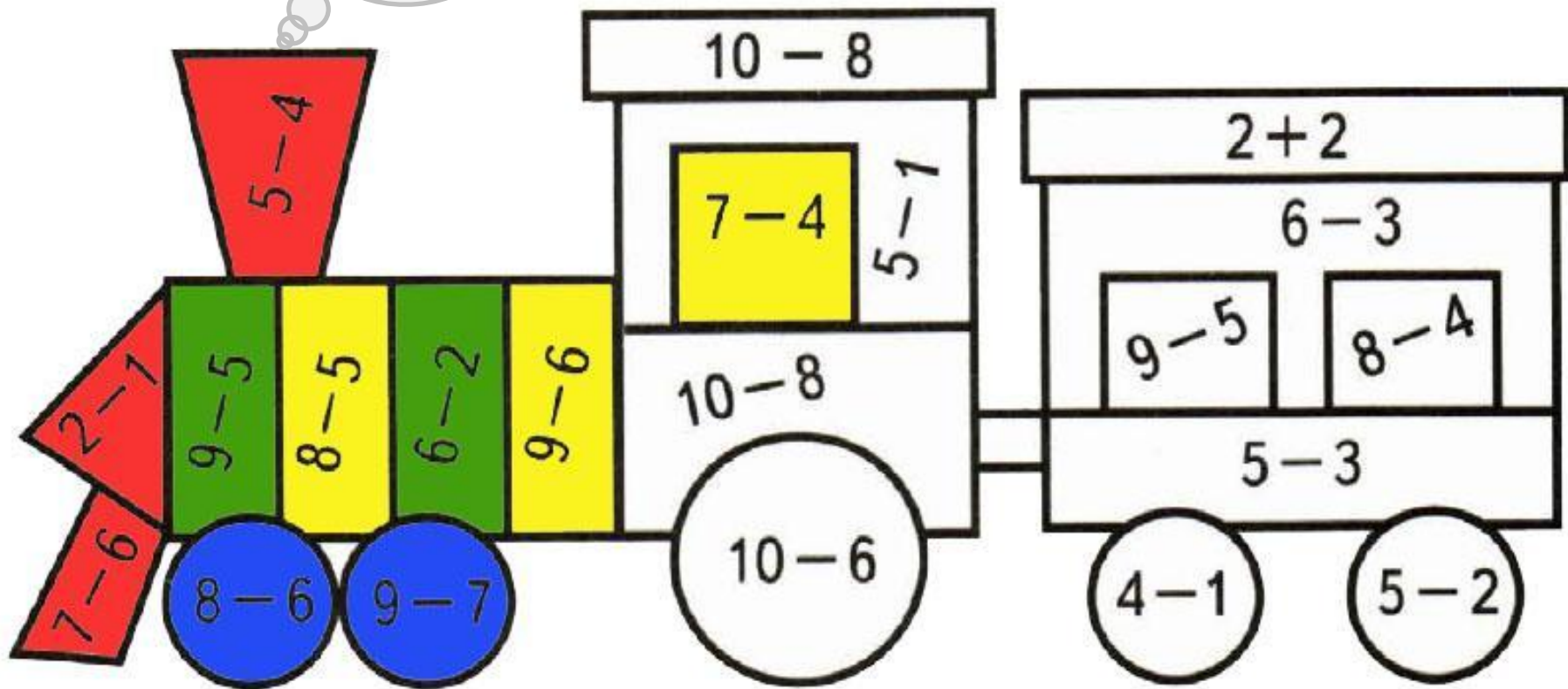

$5-1=$

Попробуй еще раз!!!

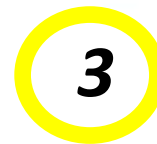
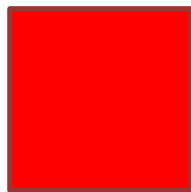
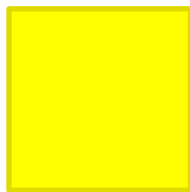
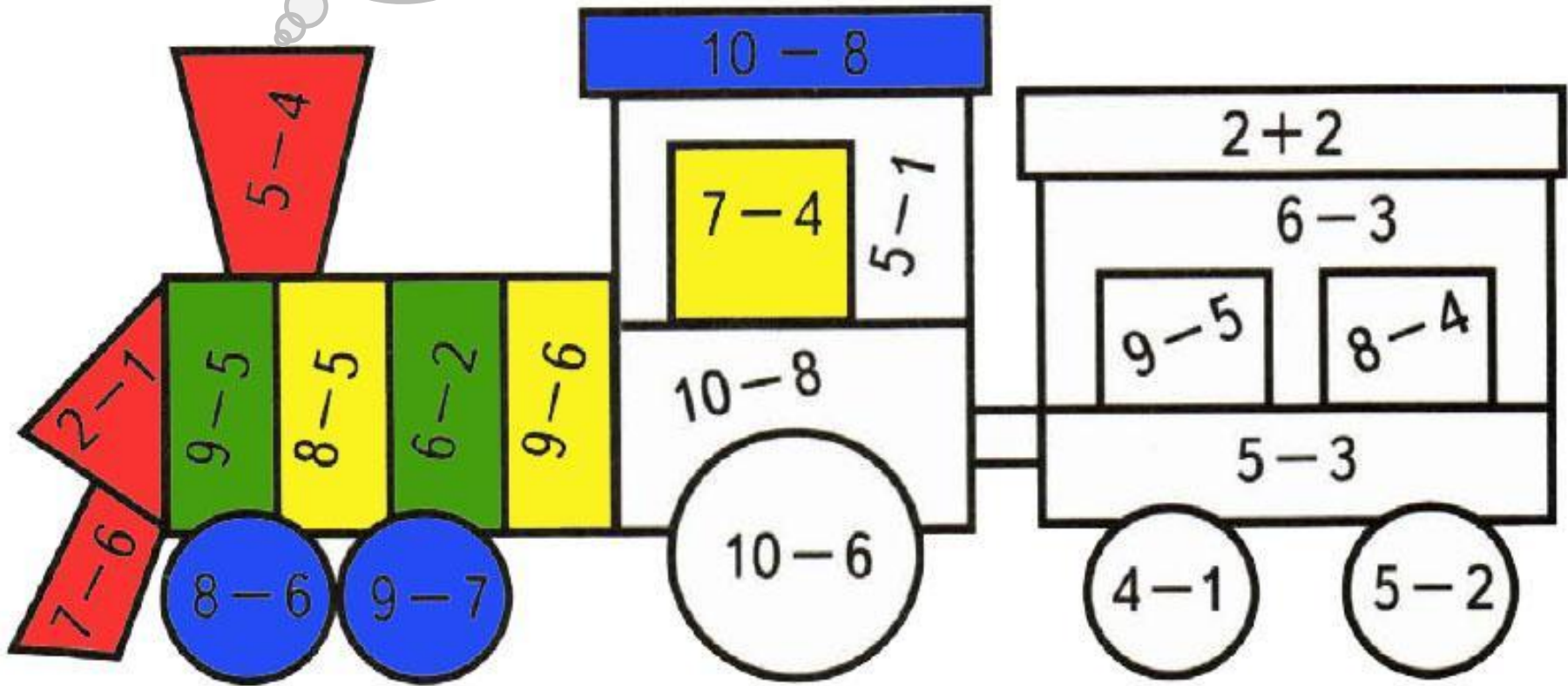

$10-8=$

Попробуй еще раз!!!

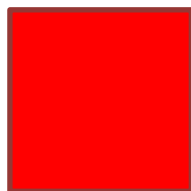
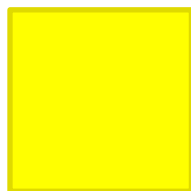
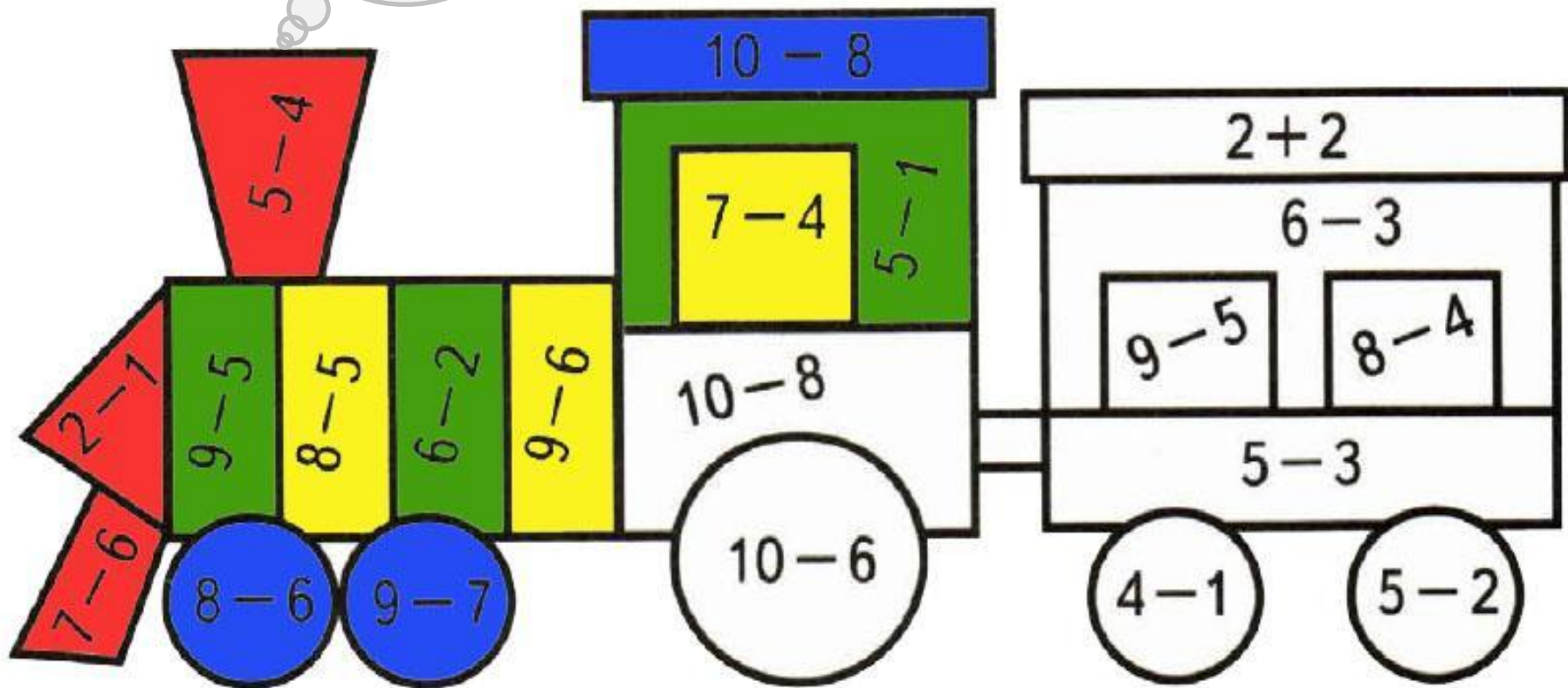

$10-6=$

Попробуй еще раз!!!

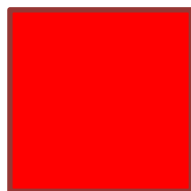
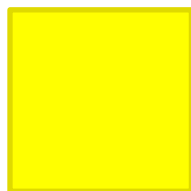
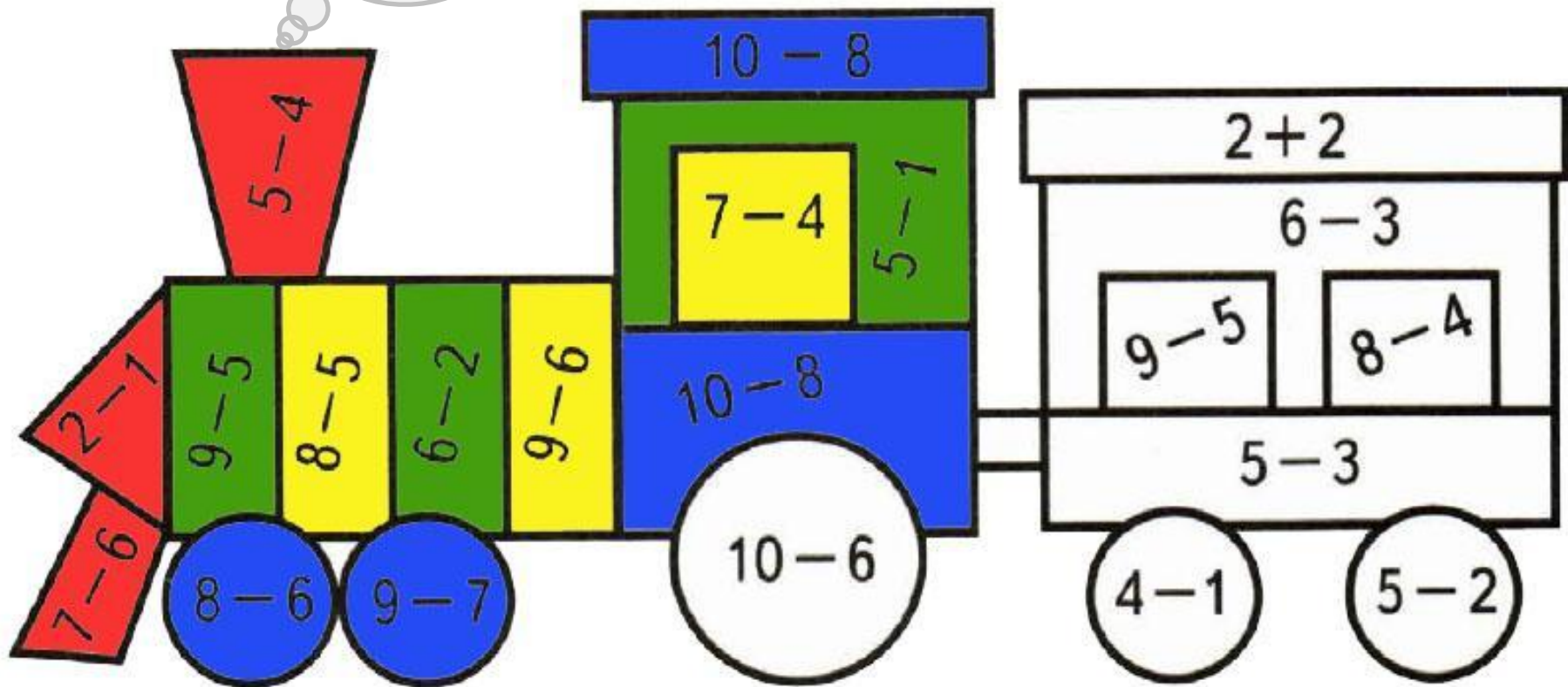

$2+2=$

Попробуй еще раз!!!

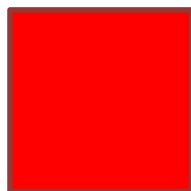
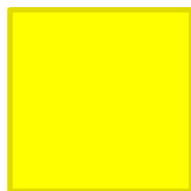
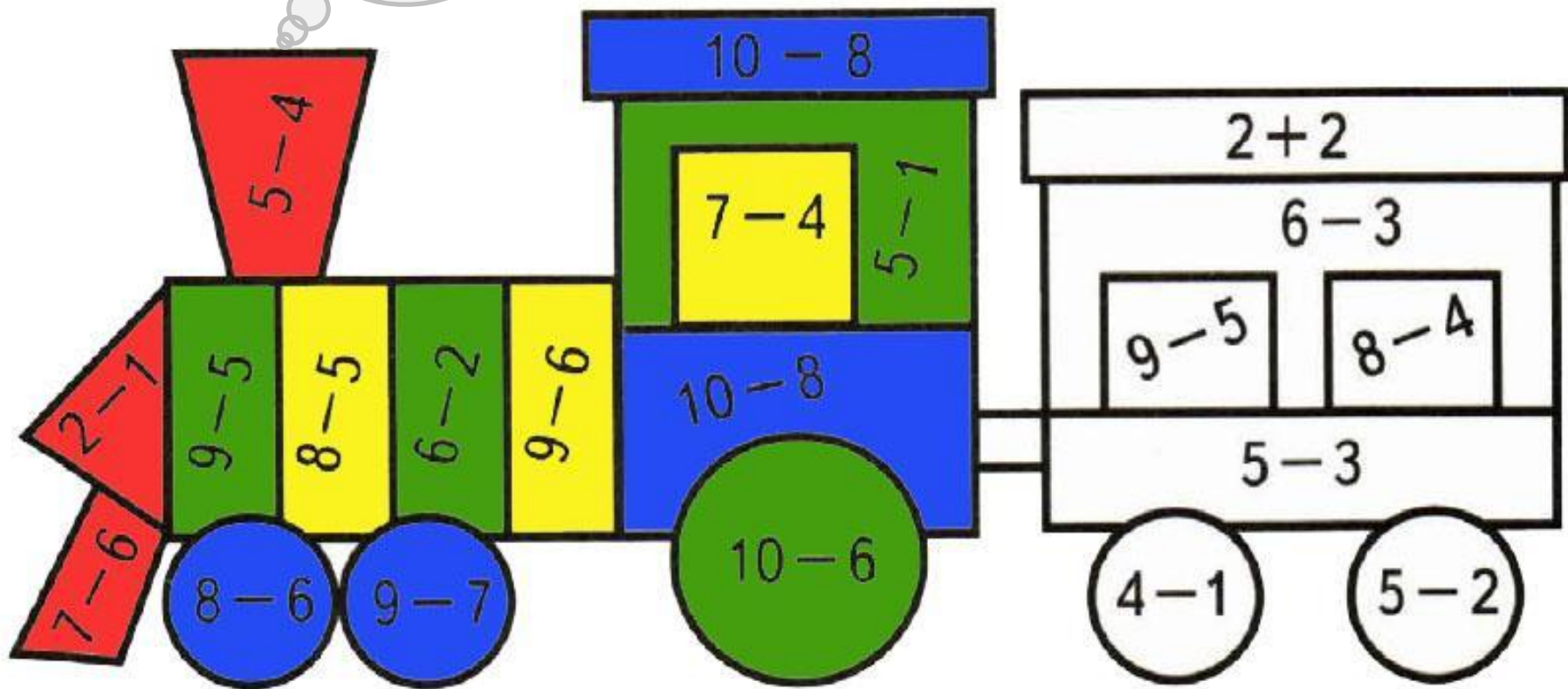

$6-3=$

Попробуй еще раз!!!

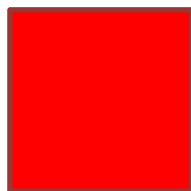
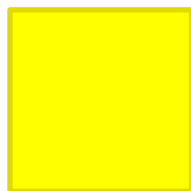
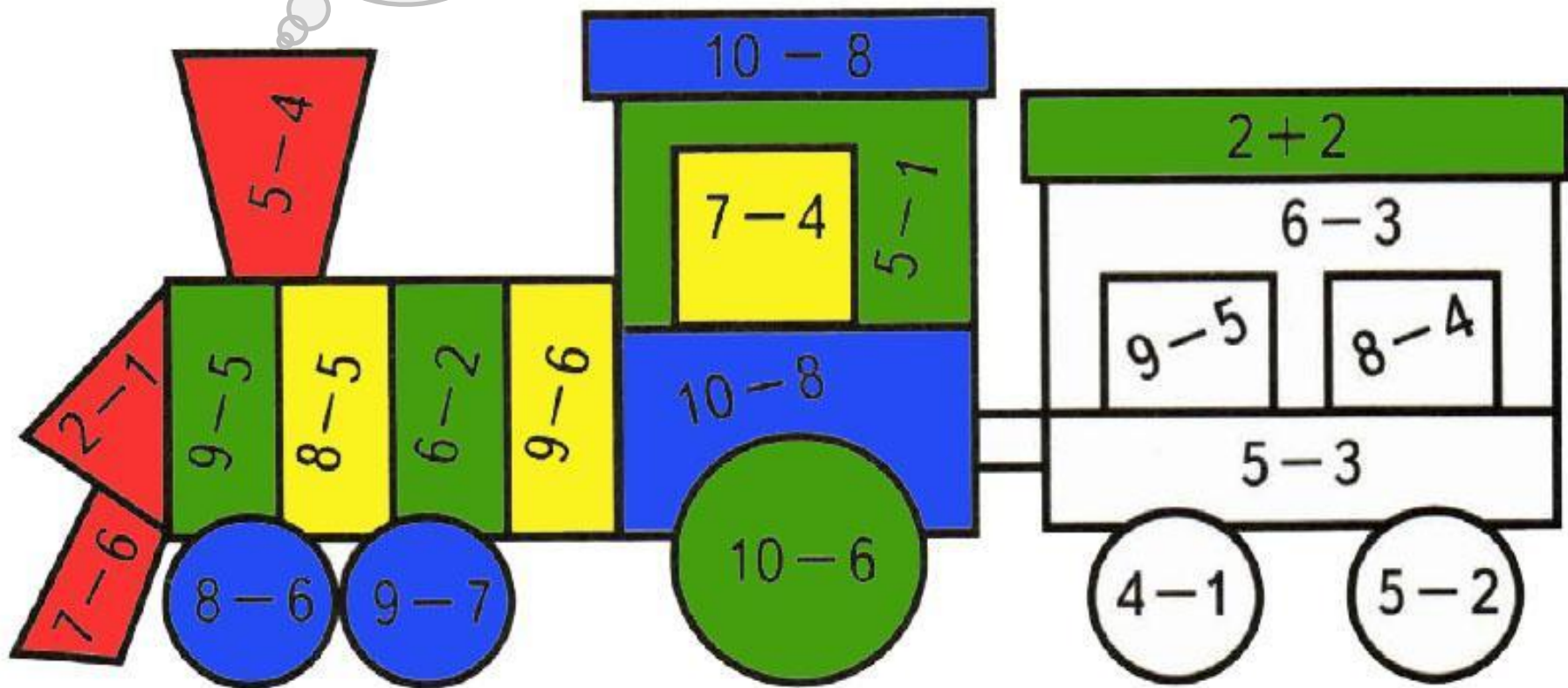

$9-5=$

Попробуй еще раз!!!

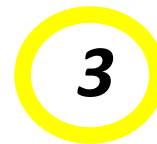
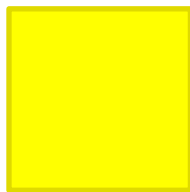
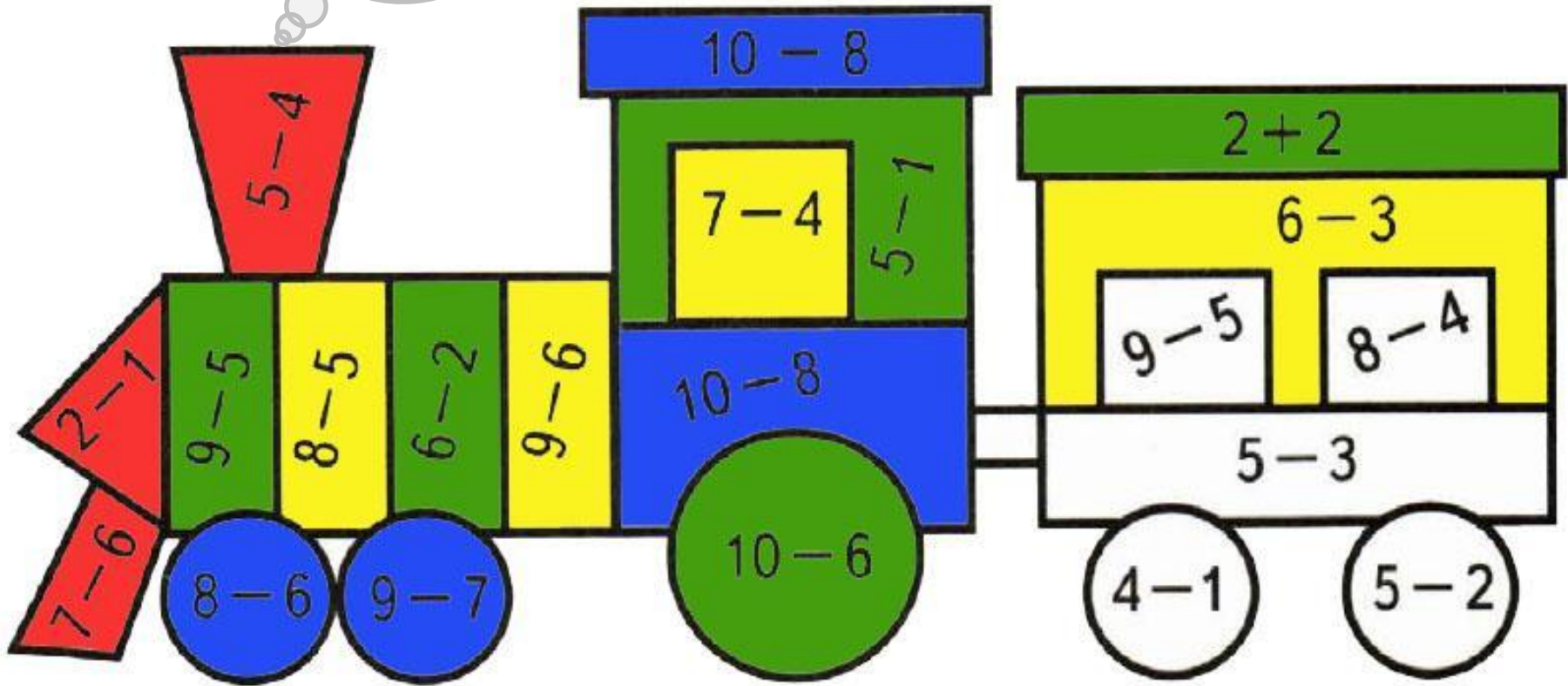

$8-4=$

Попробуй еще раз!!!

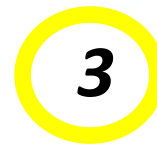
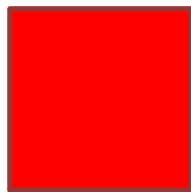
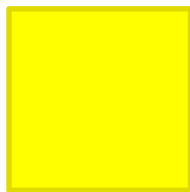
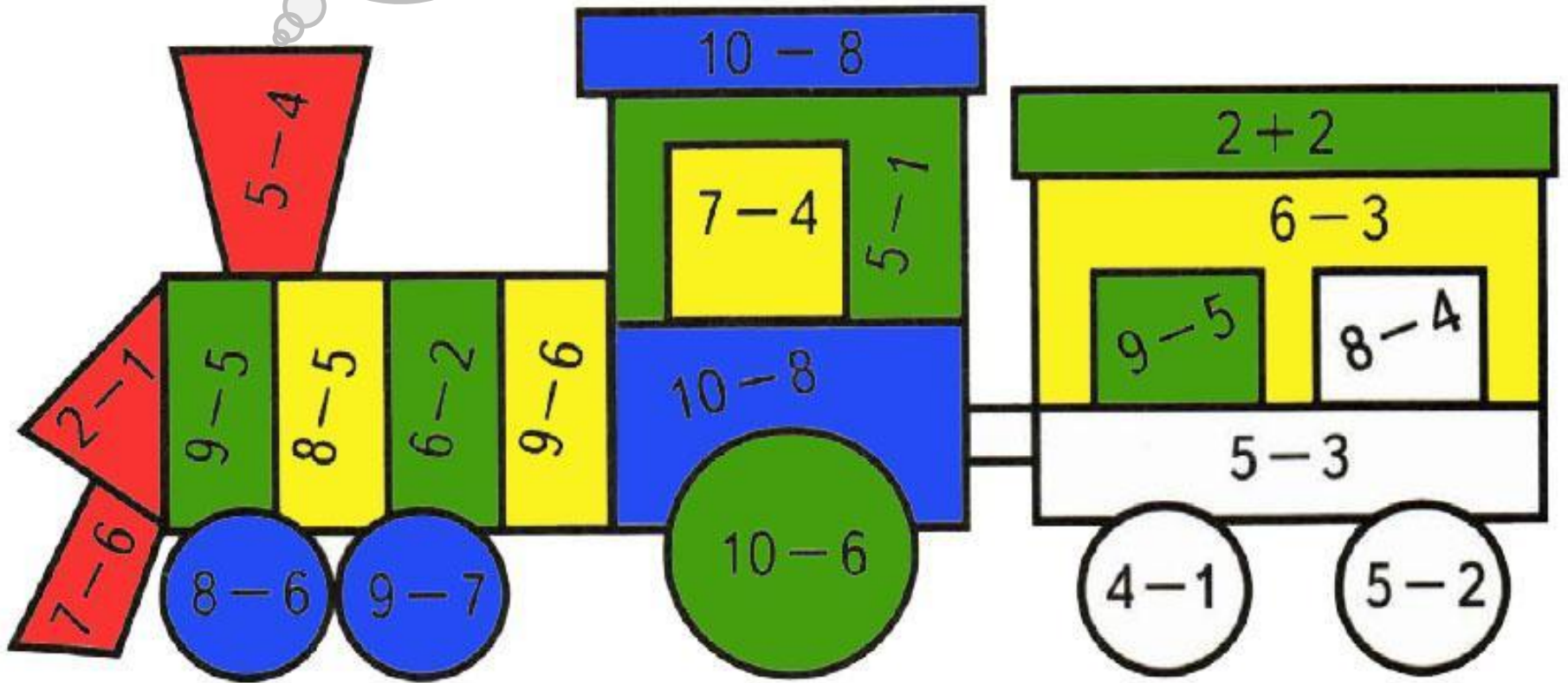

$5-3=$

Попробуй еще раз!!!

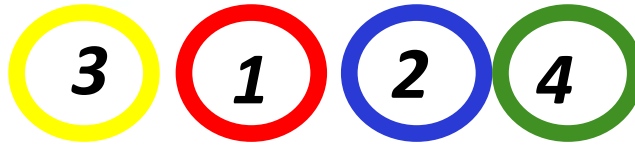
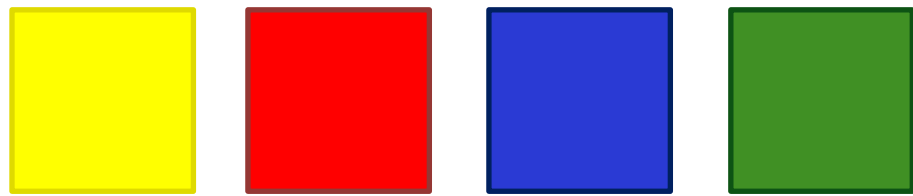
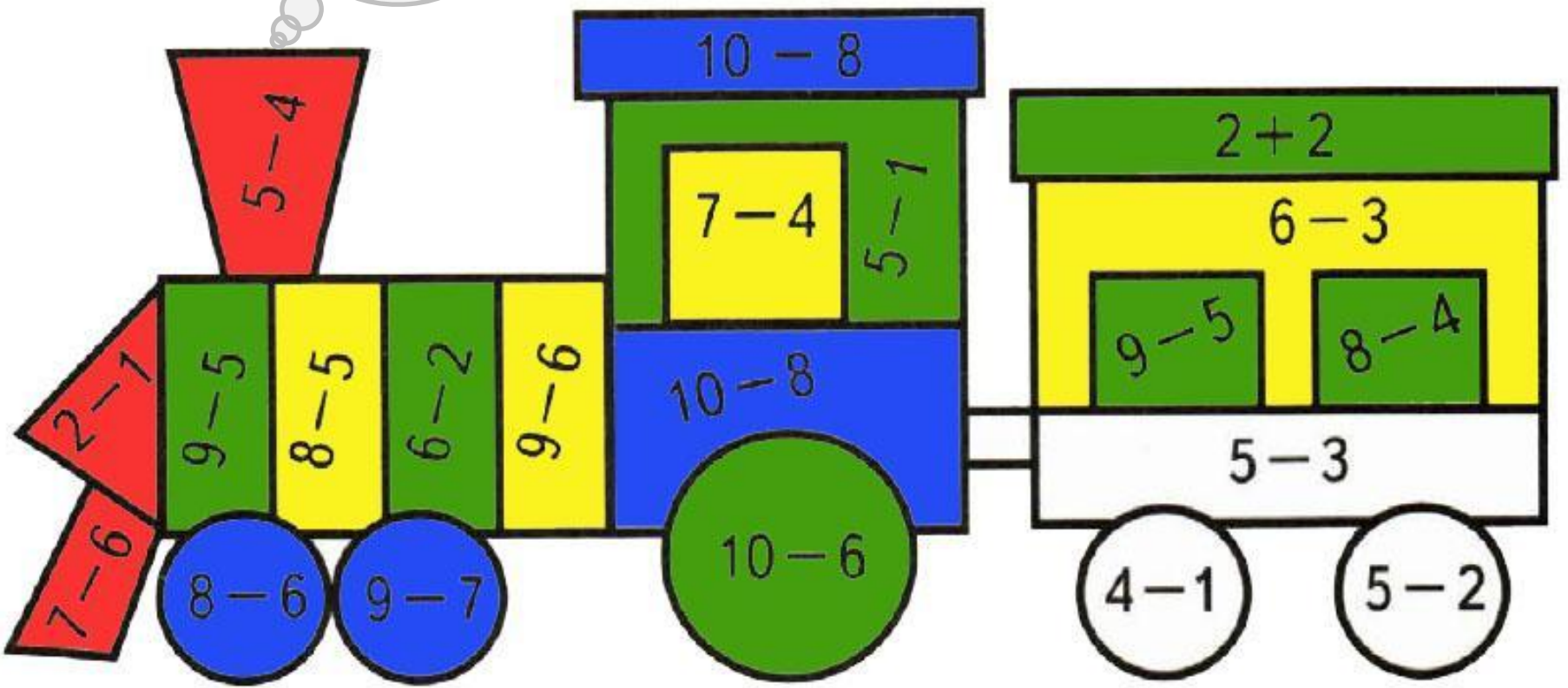

$4-1=$

Попробуй еще раз!!!

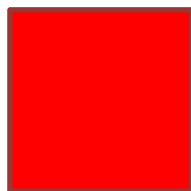
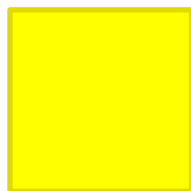
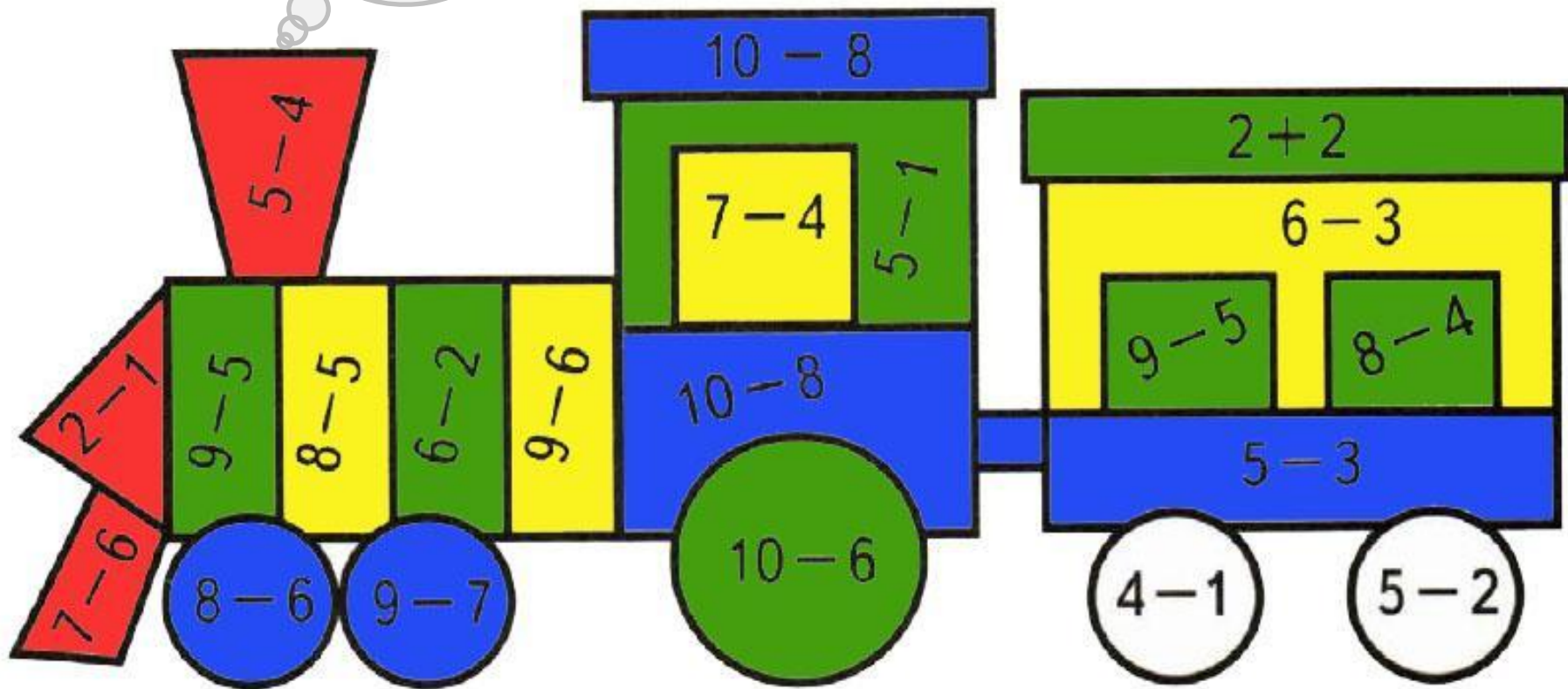

$5-2=$

Попробуй еще раз!!!

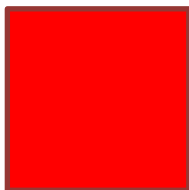
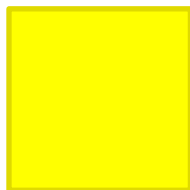
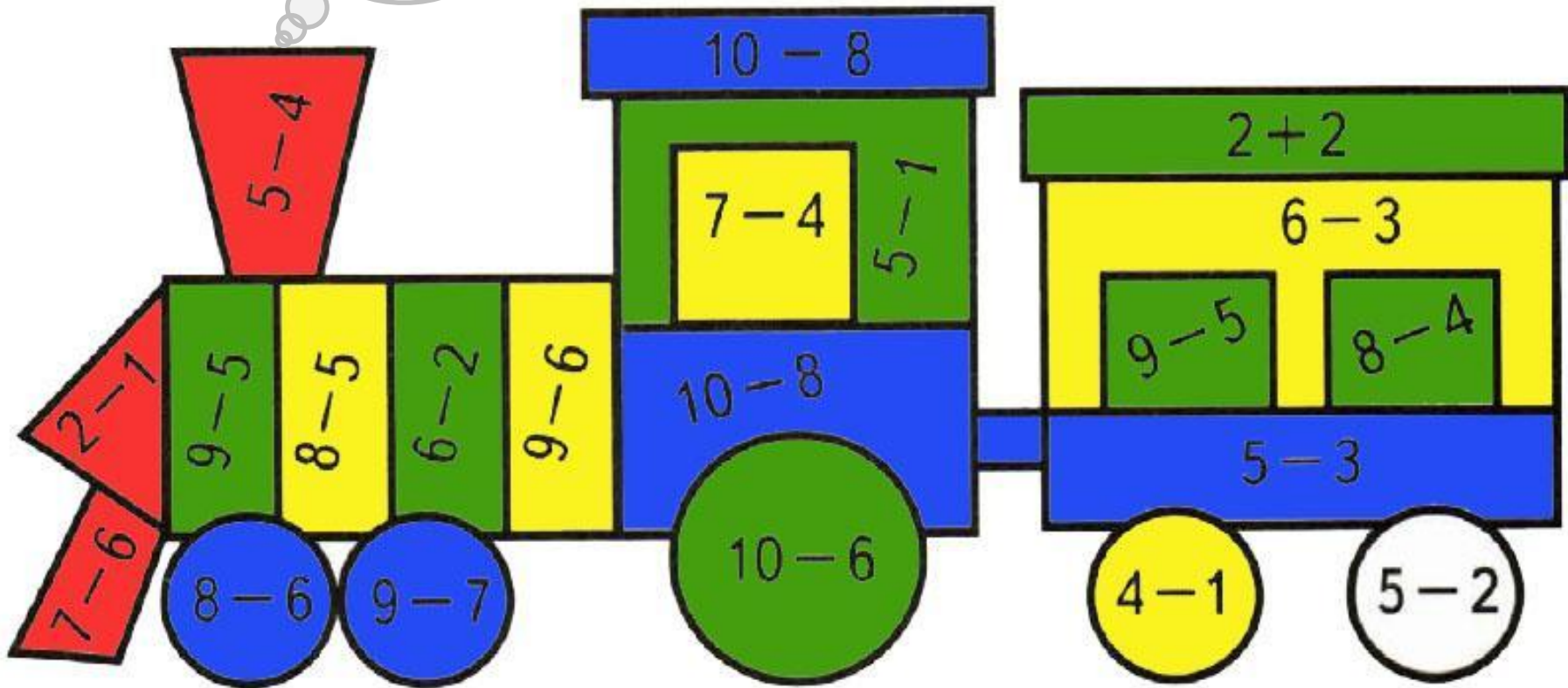

Молодцы!!!

