

Доброе утро!!!



Сколько здесь изображено
жирафов?



4

9

6



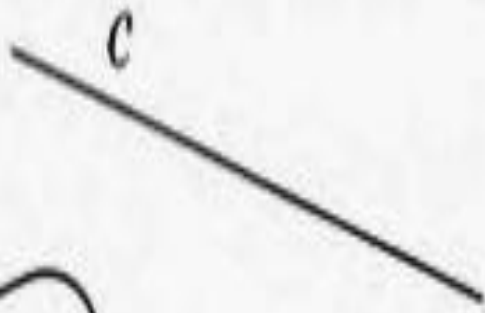

Стр. 13,
Задание №4



Стр. 13,
Задание №5

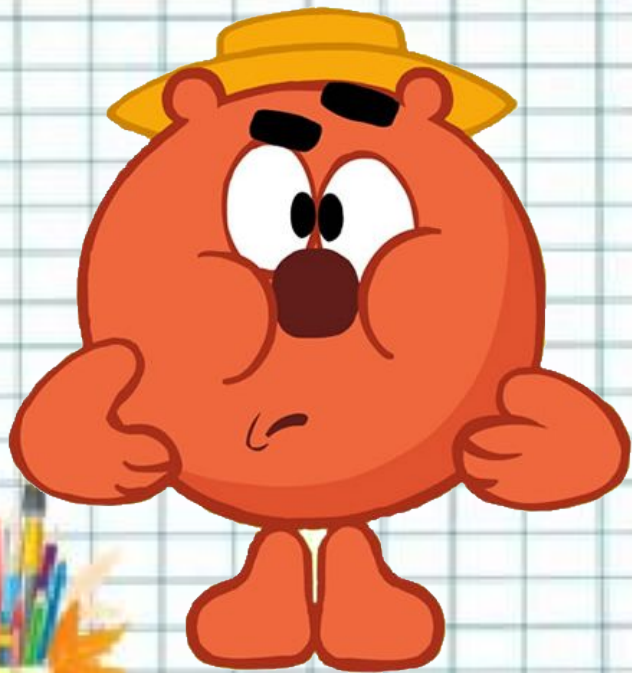



Дорисуй картинки. Назови линии, которые нарисовал.

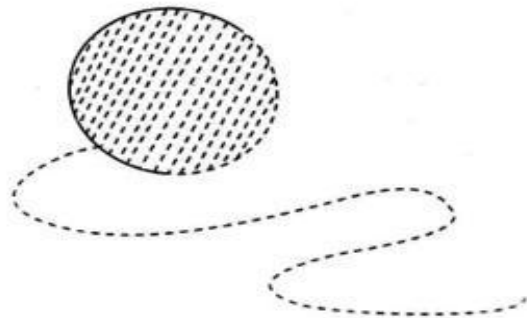
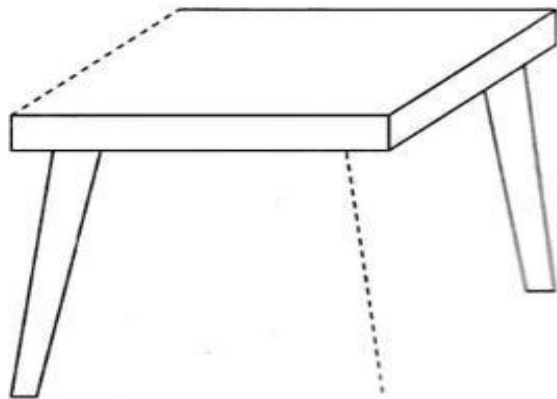
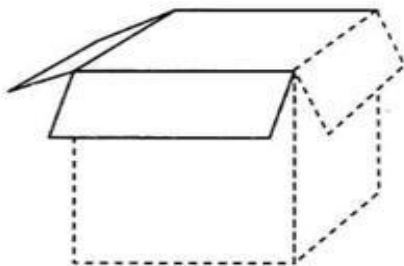
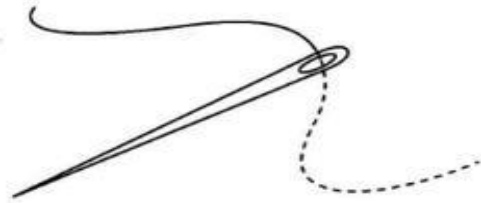
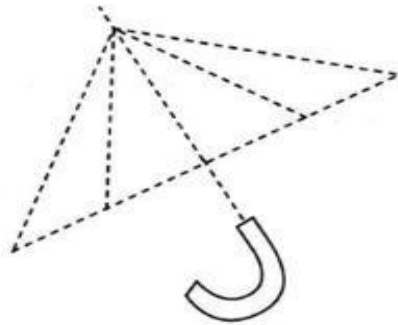



ФИЗМИНУТКА







**Спасибо за работу.
Солнечного
настроения!**

