

*Решение задач
на готовых чертежах.*

Итоговое повторение.

Часть 1.

Параллельные прямые.

Треугольники.

Геометрия.

9 класс.

*Каратанова Марина Николаевна
МОУ СОШ №256 г.Фокино*



1

2

3

4

5

6

7

8

9

10

11

12

13

14

15

16

17

18

19

20

21

22

23

24

25

26

27

28

29

30

1. Дано: $MD \parallel NK$ а b

Вопрос: $\angle D$ $\hat{=}$ $\angle K$ а b ?

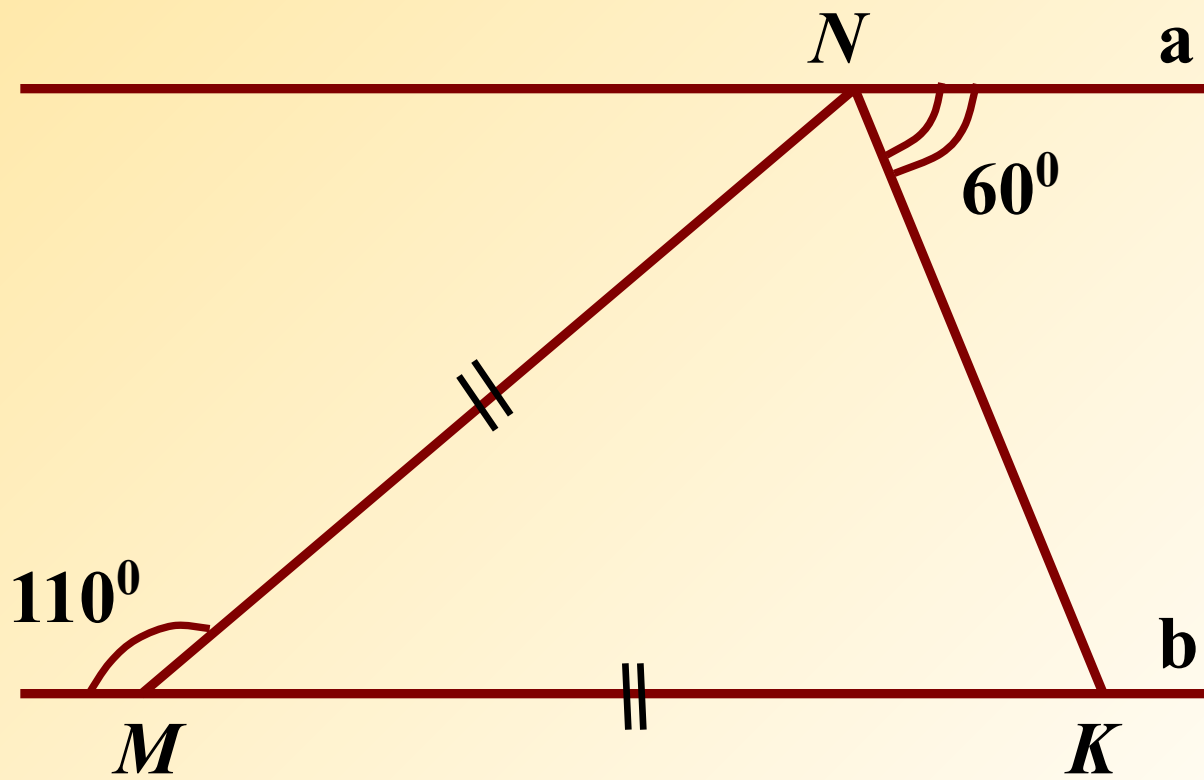

2.

Дано:

і *д* *у* *і* *а*

а, *б*, *н* *є* *д*

Найти:

$\angle 1$, $\angle 2$

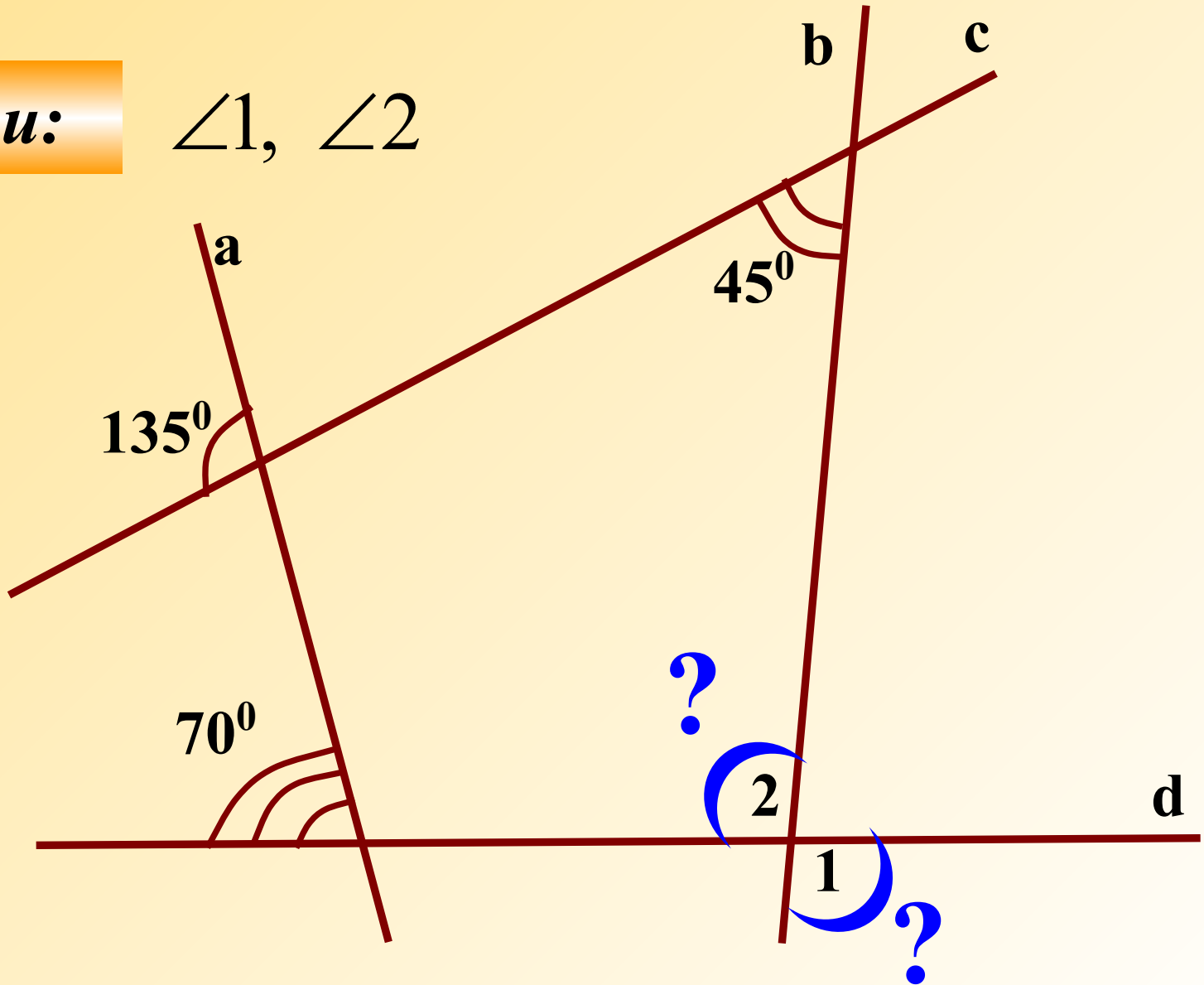

3.

Дано:

BD – аєññâêòðèñ à $\angle A\hat{A}\tilde{N}$

Найти:

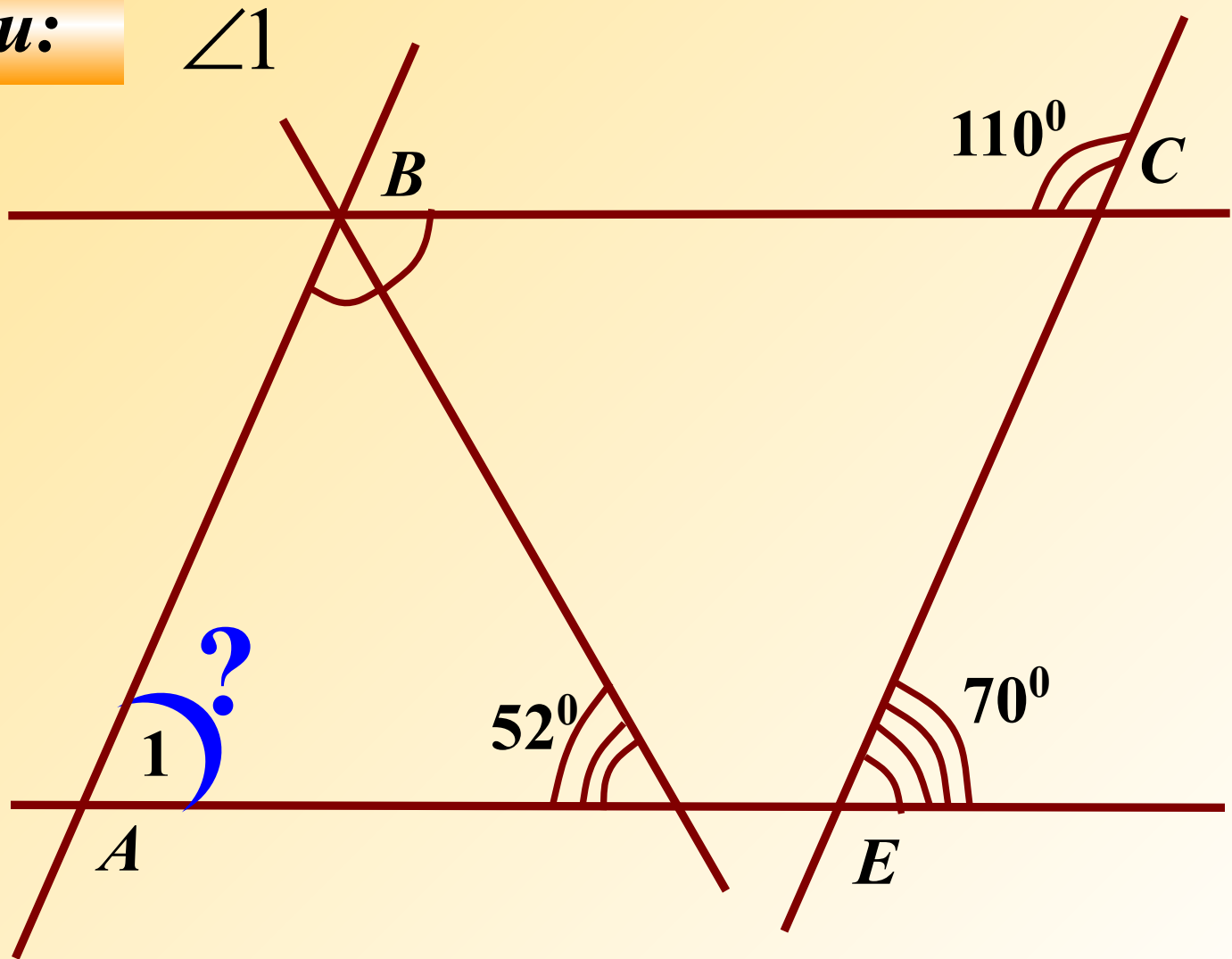

4.

Дано:

$$\hat{O}E = \hat{E}D$$

Найти:

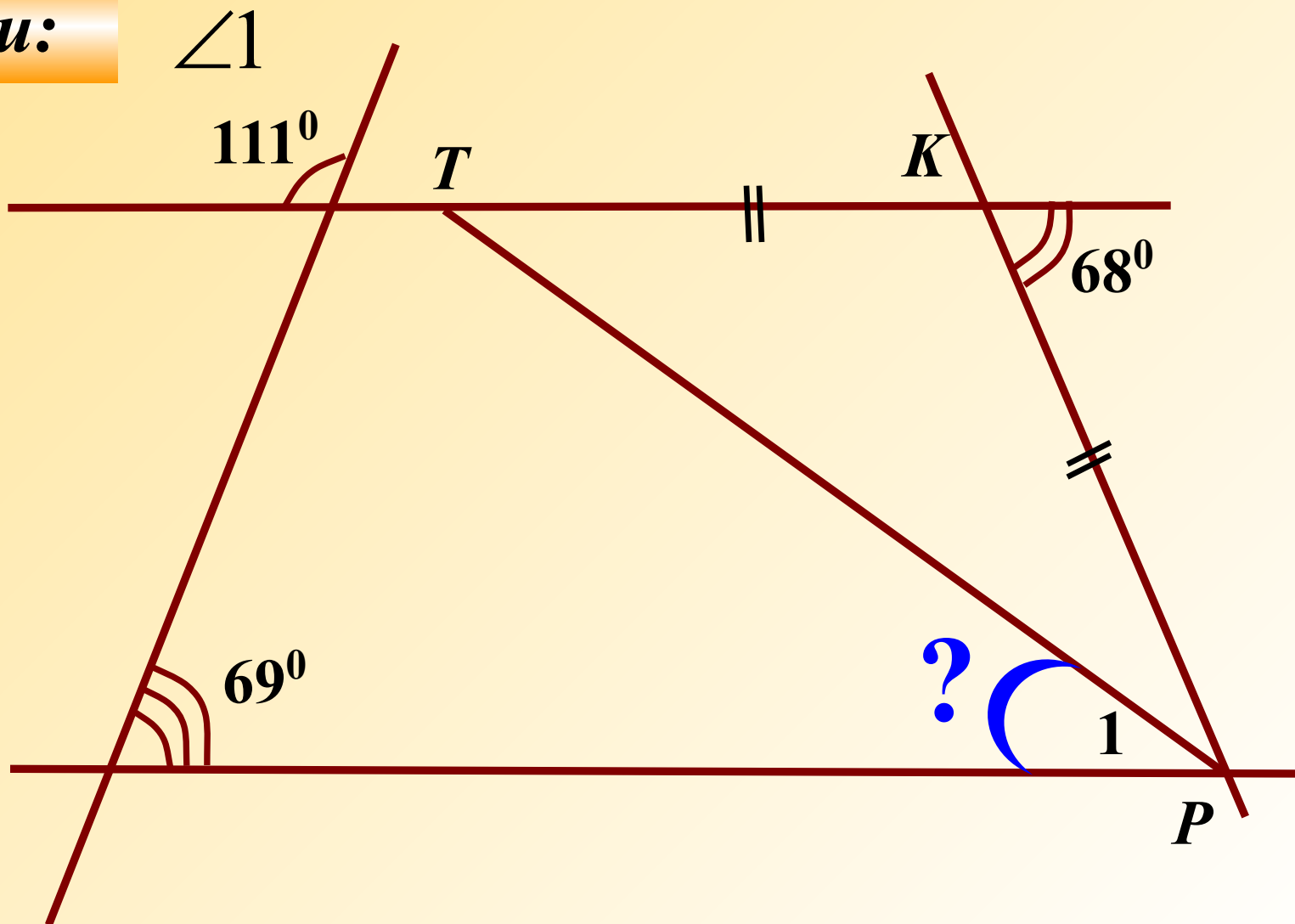

5.

Дано:

$AB \parallel CD$

Найти:

$\angle 1$

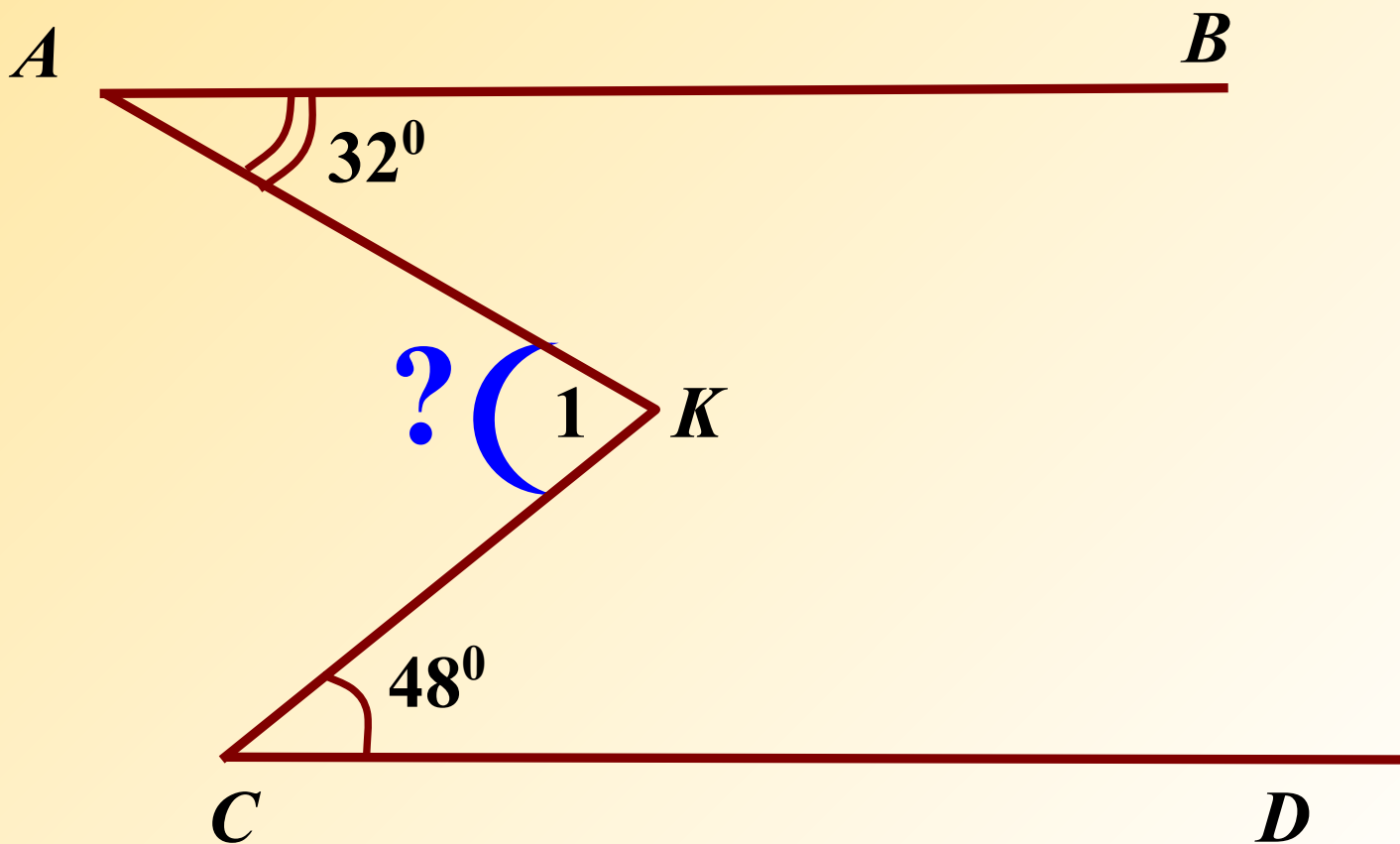

6.

Дано: $a \parallel b$, $\hat{A} = 4,2\tilde{n}$

Найти: MN

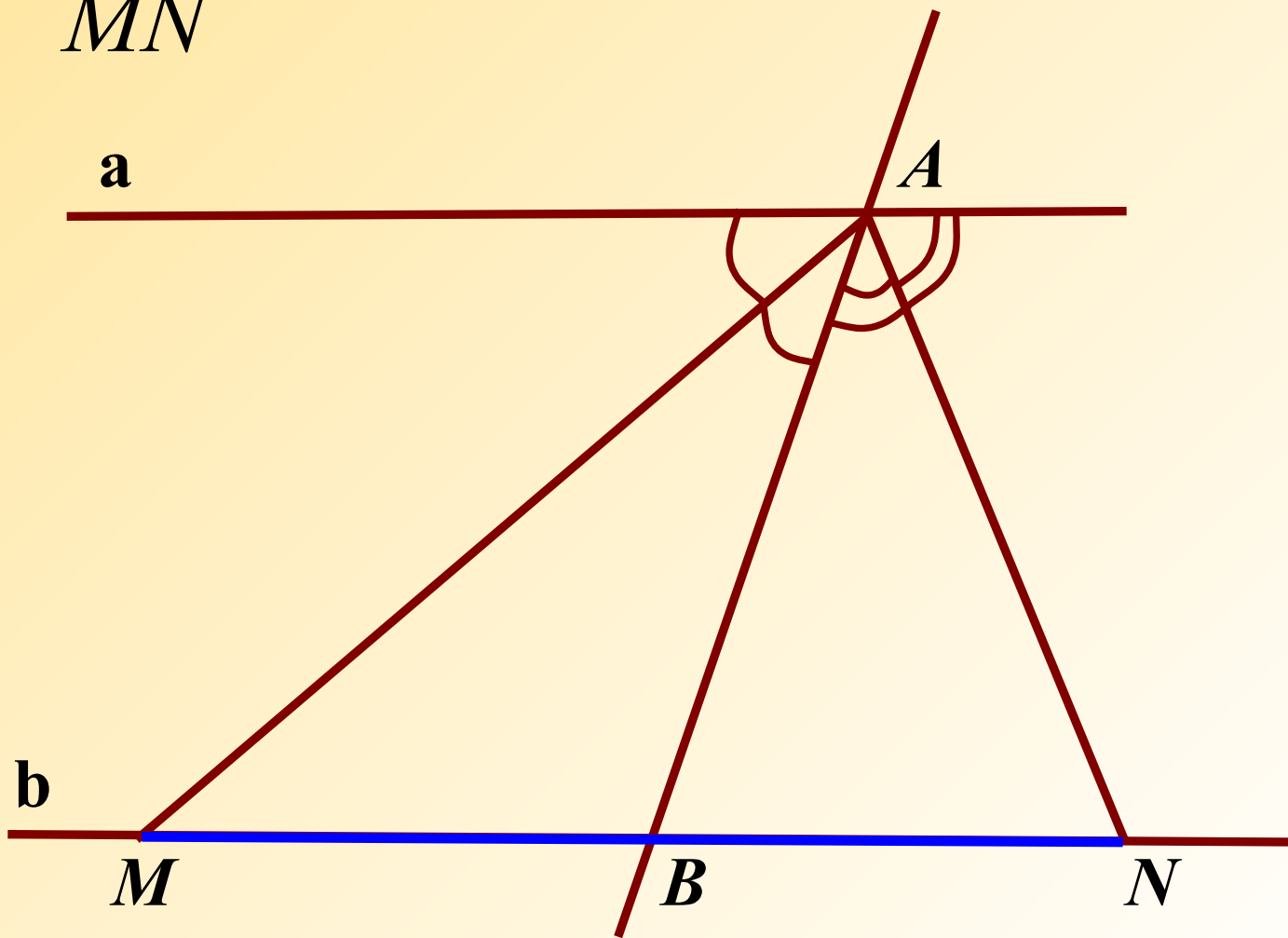

7.

Дано: $C\tilde{i}$. $\delta\grave{e}\tilde{n}$.

Найти: $\angle A\tilde{I}N$

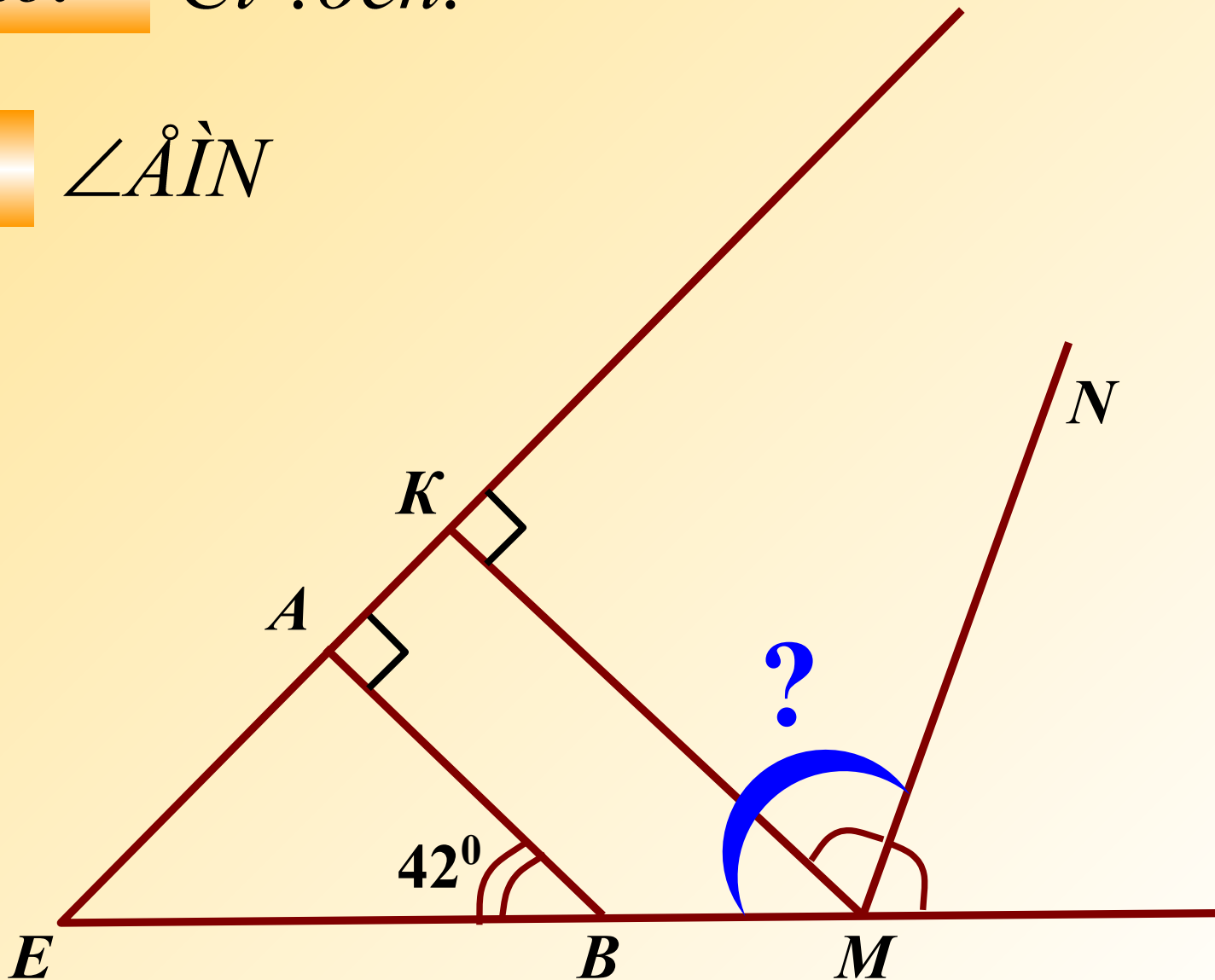

8.

Дано:

$\hat{A}\hat{N}\hat{E} \parallel DE$

Найти:

$\angle \hat{A}\hat{N}\hat{E}$

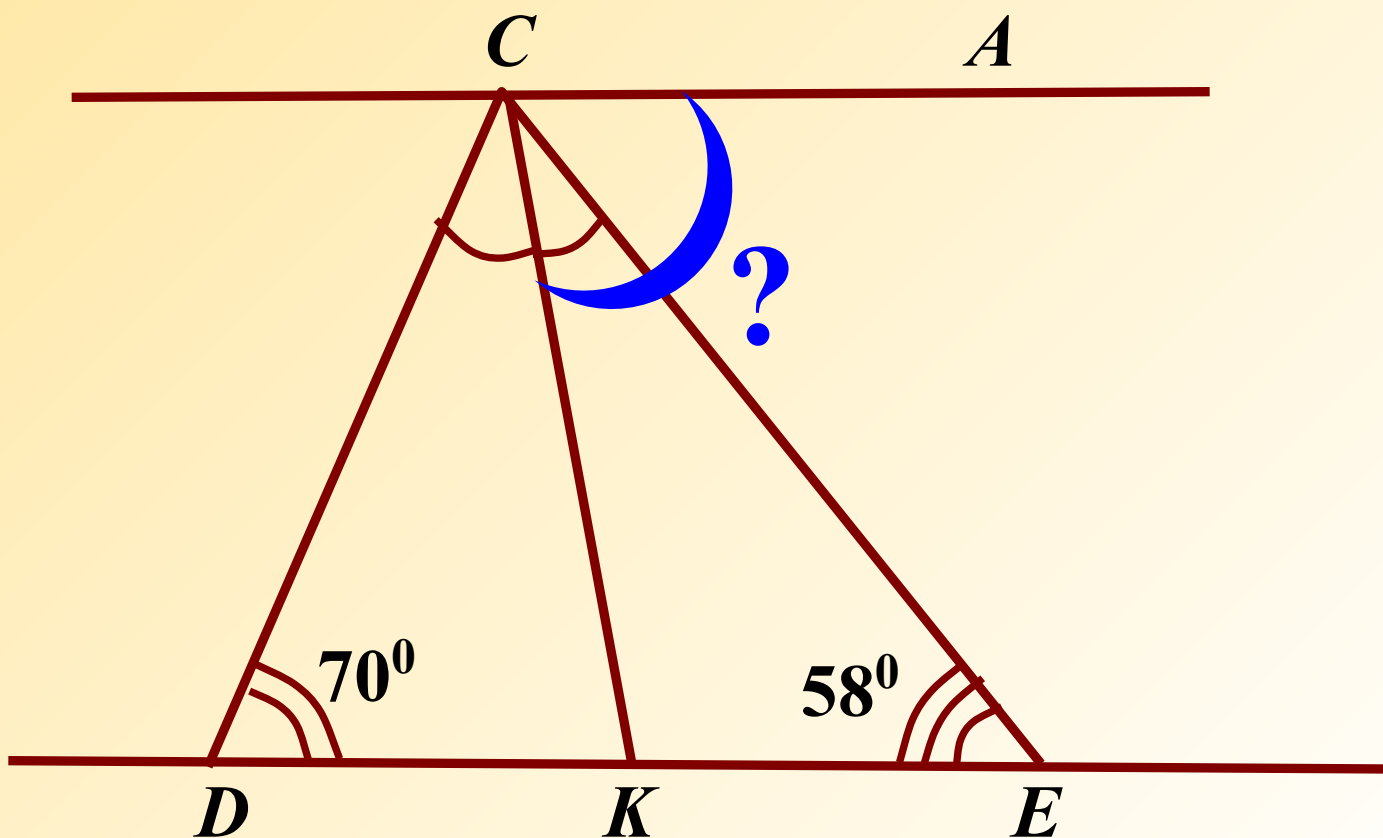

9.

Дано: $AB = 7\text{ см}$, $AM^2 - MB^2 = 7$

Найти: AM , MB

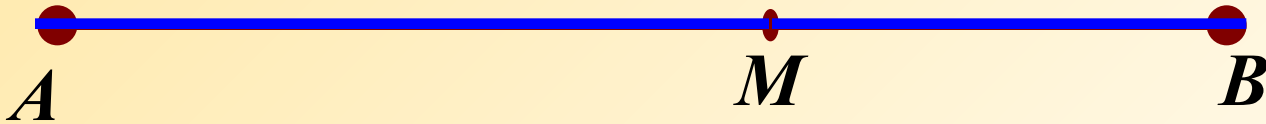

10.

Дано:

$$\frac{1}{3} A\hat{E} = \frac{1}{4} \hat{A}E, \quad A\hat{A} = 14\tilde{n}i$$

Найти:

$$\hat{A}E, \quad B\hat{E}$$

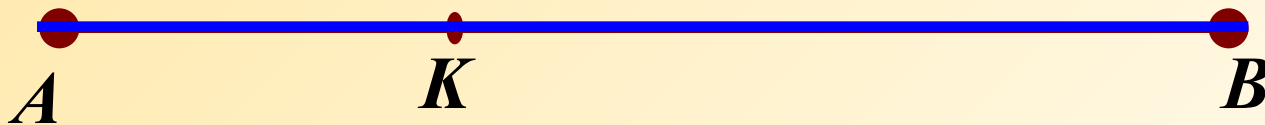

11.

Дано: $AB = 15,6$, $AD = 7,5$, $CB = 10,2$

Найти: \tilde{ND}



12.

Дано:

$$\angle \hat{A} \hat{I} \hat{N} = 63^{\circ}, \angle \hat{A} \hat{I} \hat{D} = 57^{\circ},$$
$$\angle \hat{A} \hat{I} \hat{B} = 85^{\circ}$$

Найти:

$$\angle \hat{D} \hat{I} \hat{C}$$

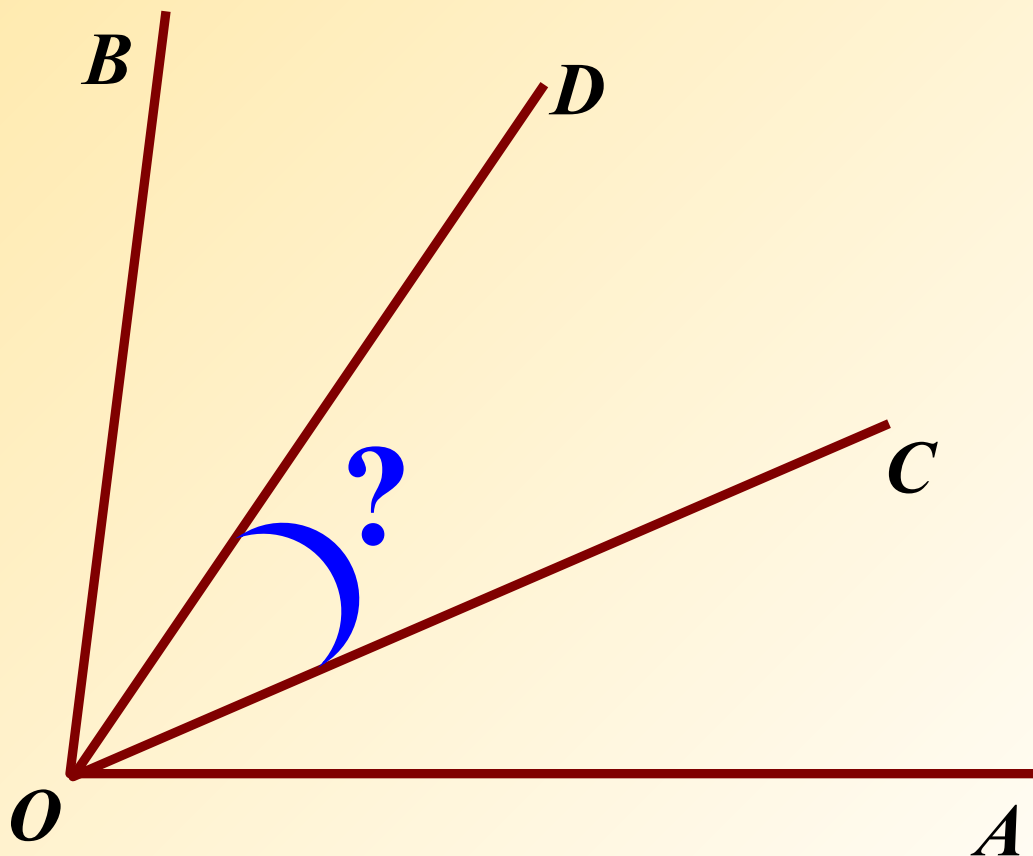

13.

Дано: $C\tilde{i}$. $\delta\grave{e}\tilde{n}$.

Найти:

$\angle A\tilde{N}E$

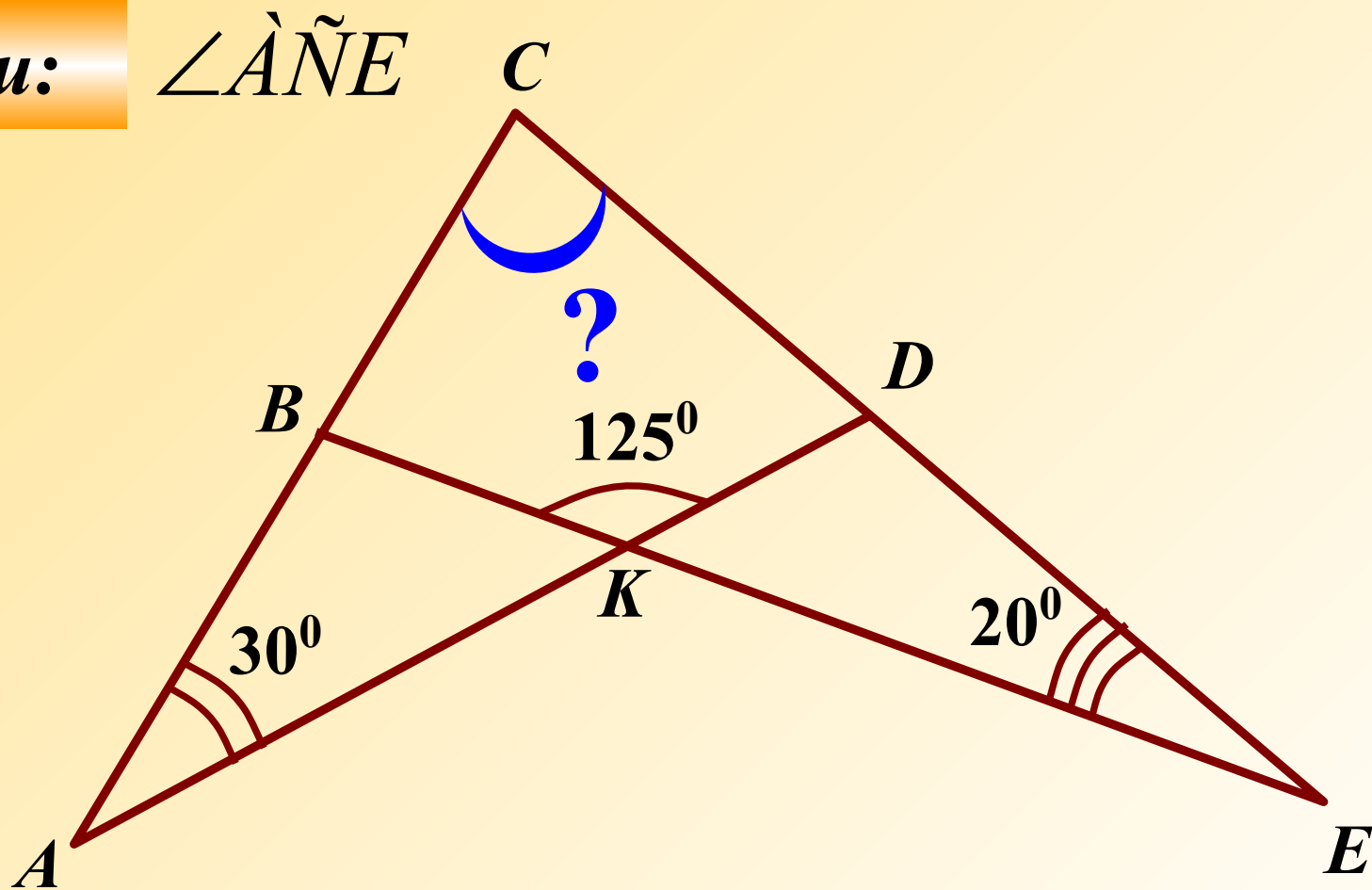

14.

Дано: $\triangle MPK$

Найти: $M\hat{E}$

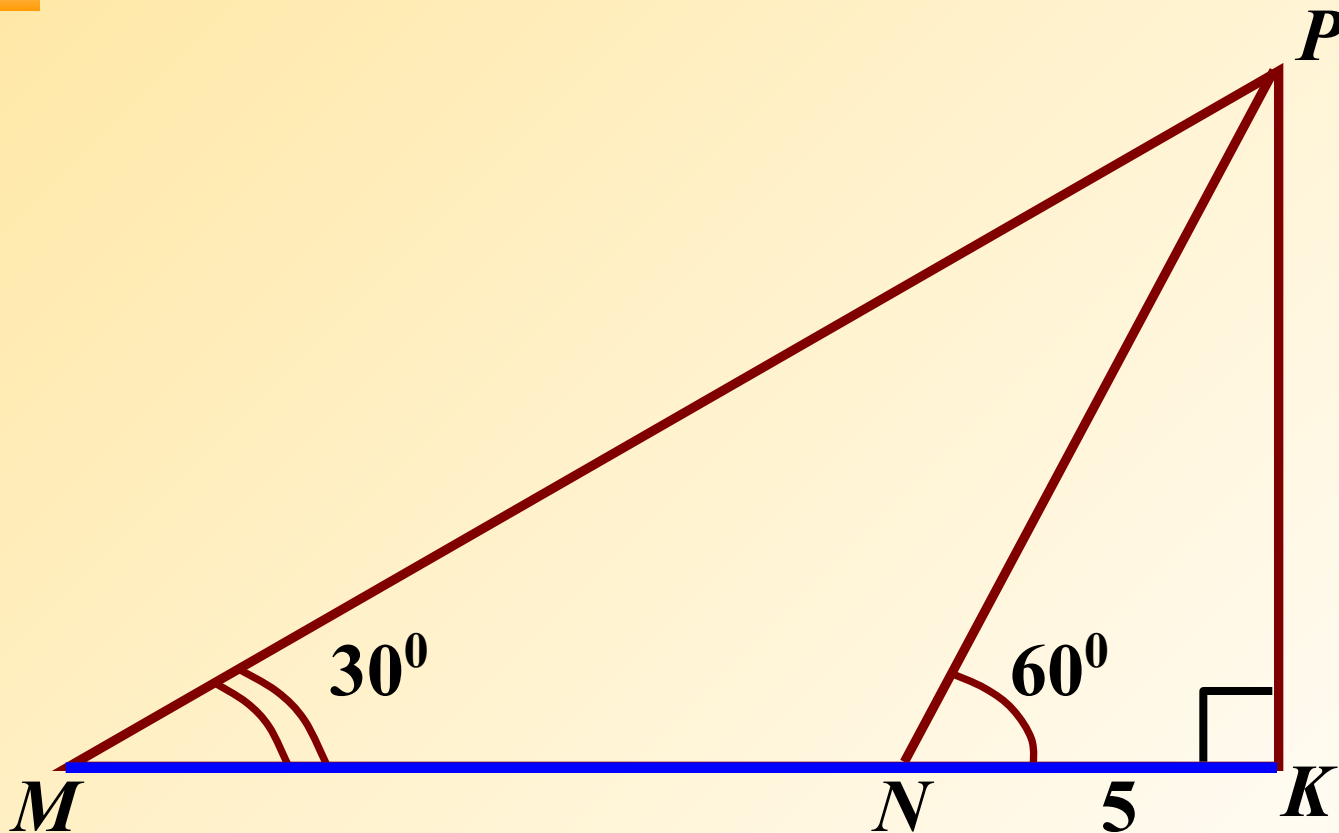

15.

Дано:

$\triangle ABC$

Найти:

$\hat{A}\hat{A}$

B

D

3

C

A

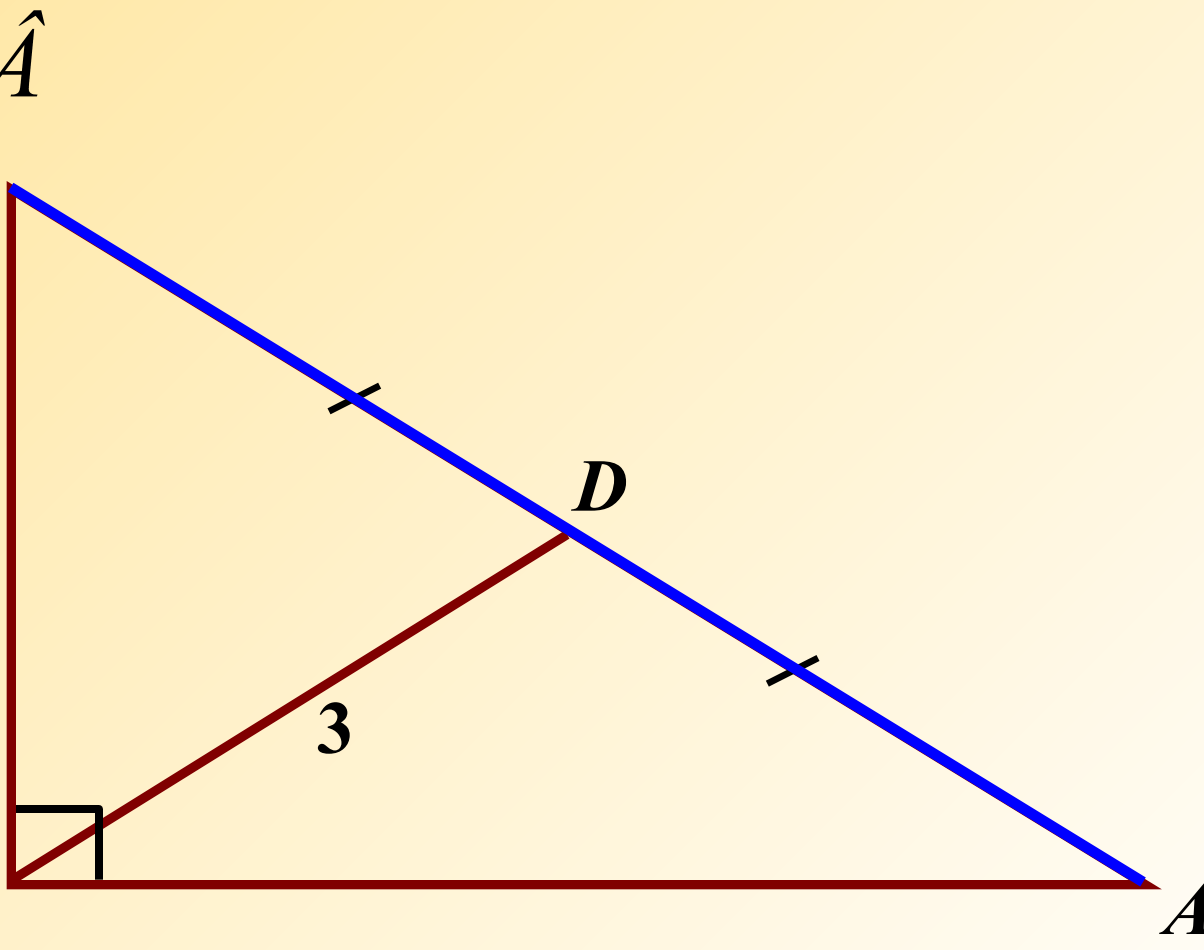

16.

Дано:

$a \parallel b$

Найти:

x, y

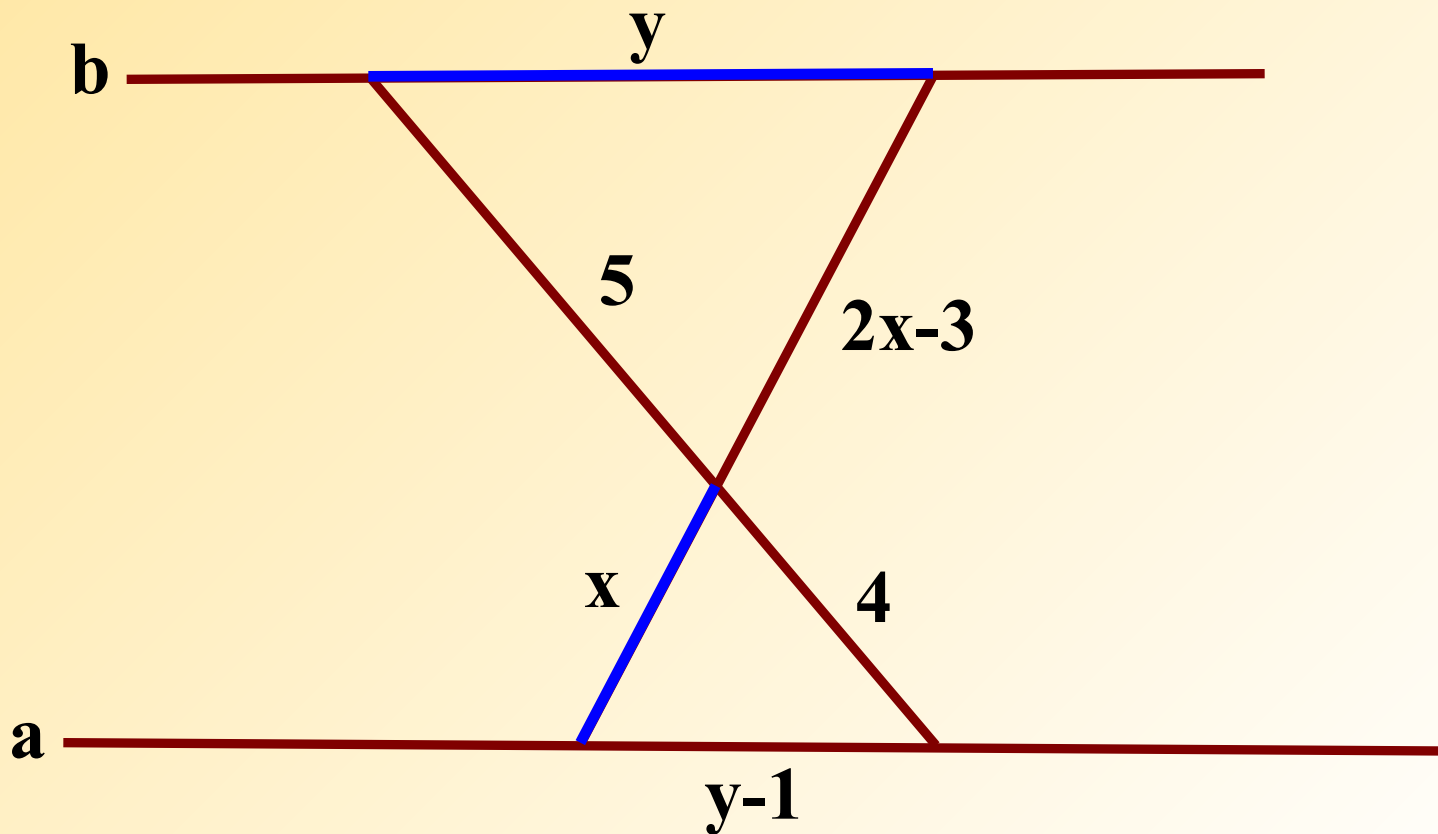

17.

Дано:

$\triangle ABC$

Найти:

$\hat{A}D$

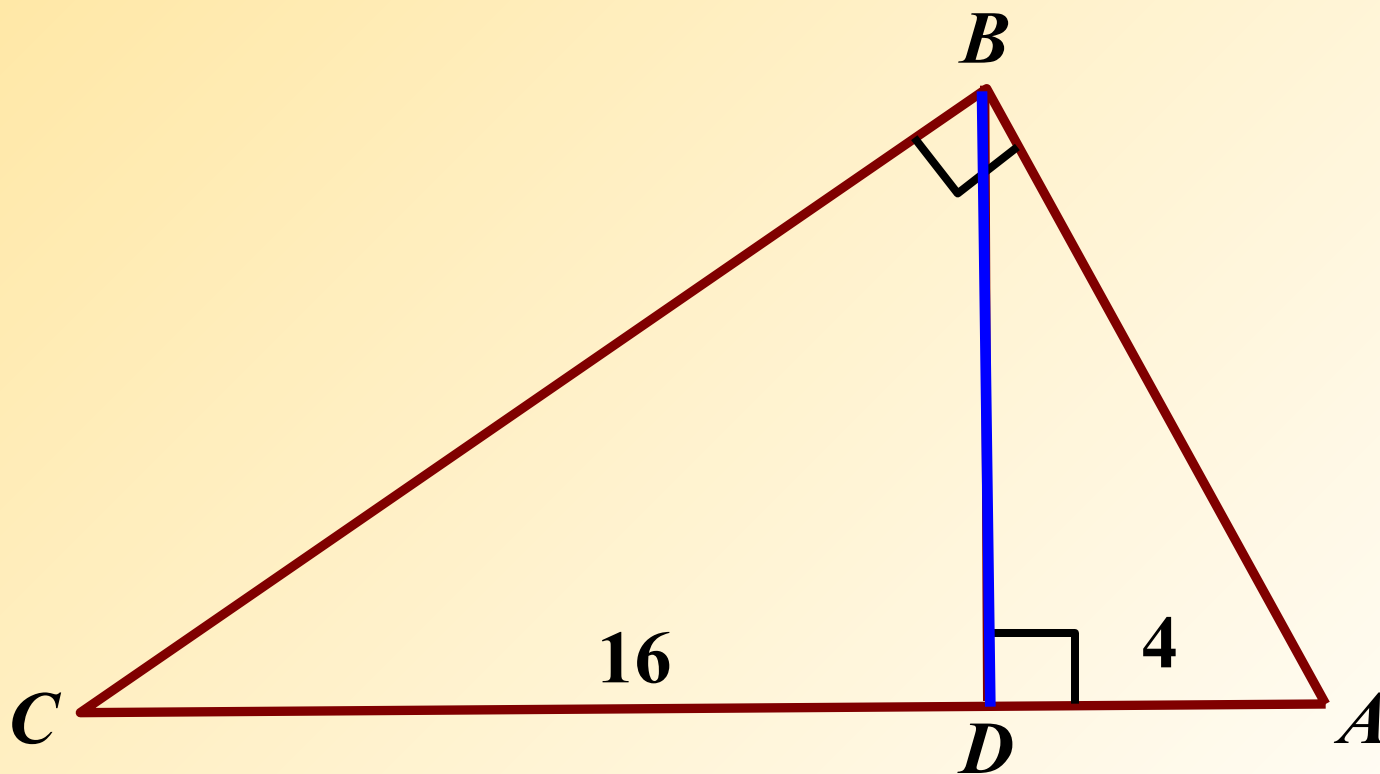

18.

Дано: $\angle 3 = \angle 1 + \angle 2$, $\tilde{N}D = 4$, $CB = 9$

Найти: $A\tilde{N}$

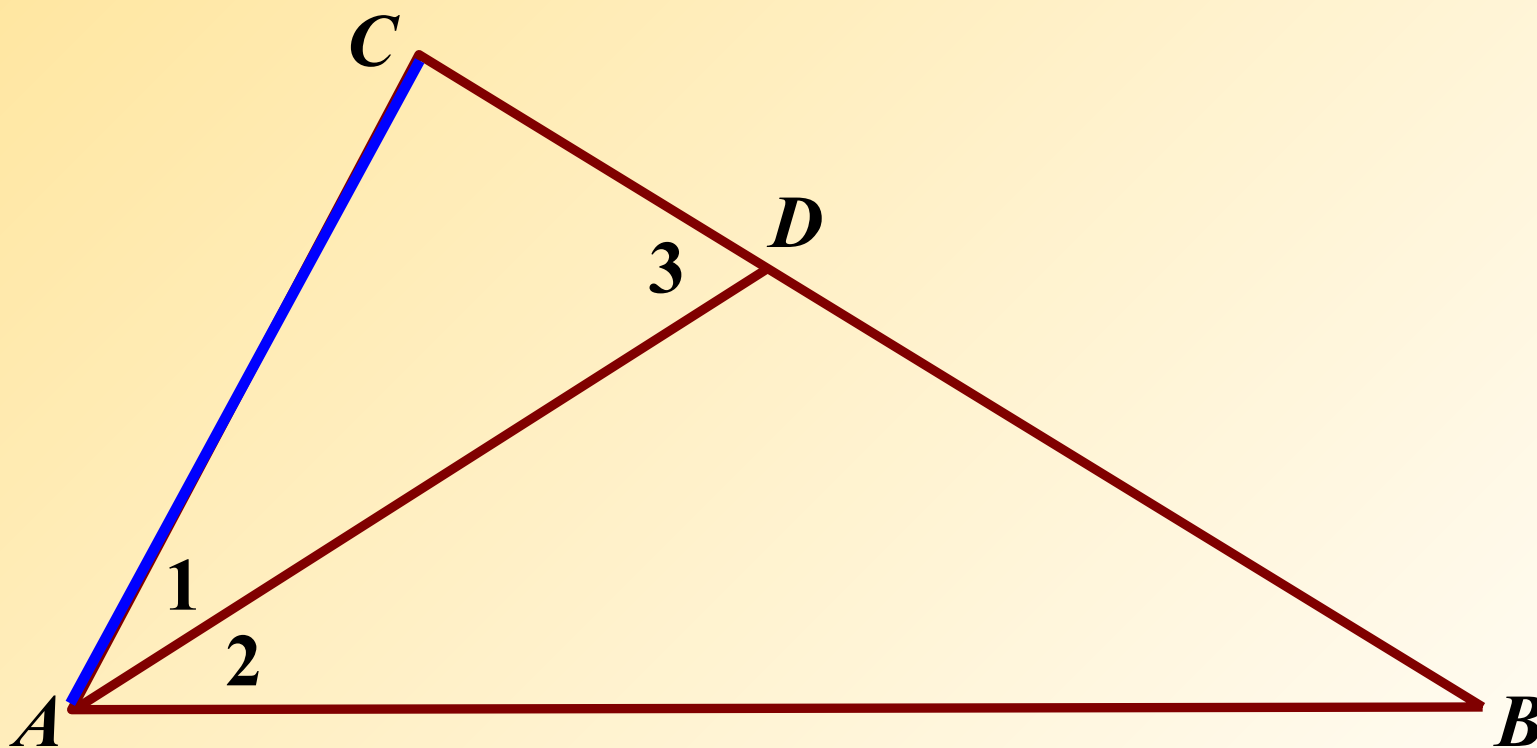

19.

Дано:

$AC \parallel BD$

Найти:

CO, OB

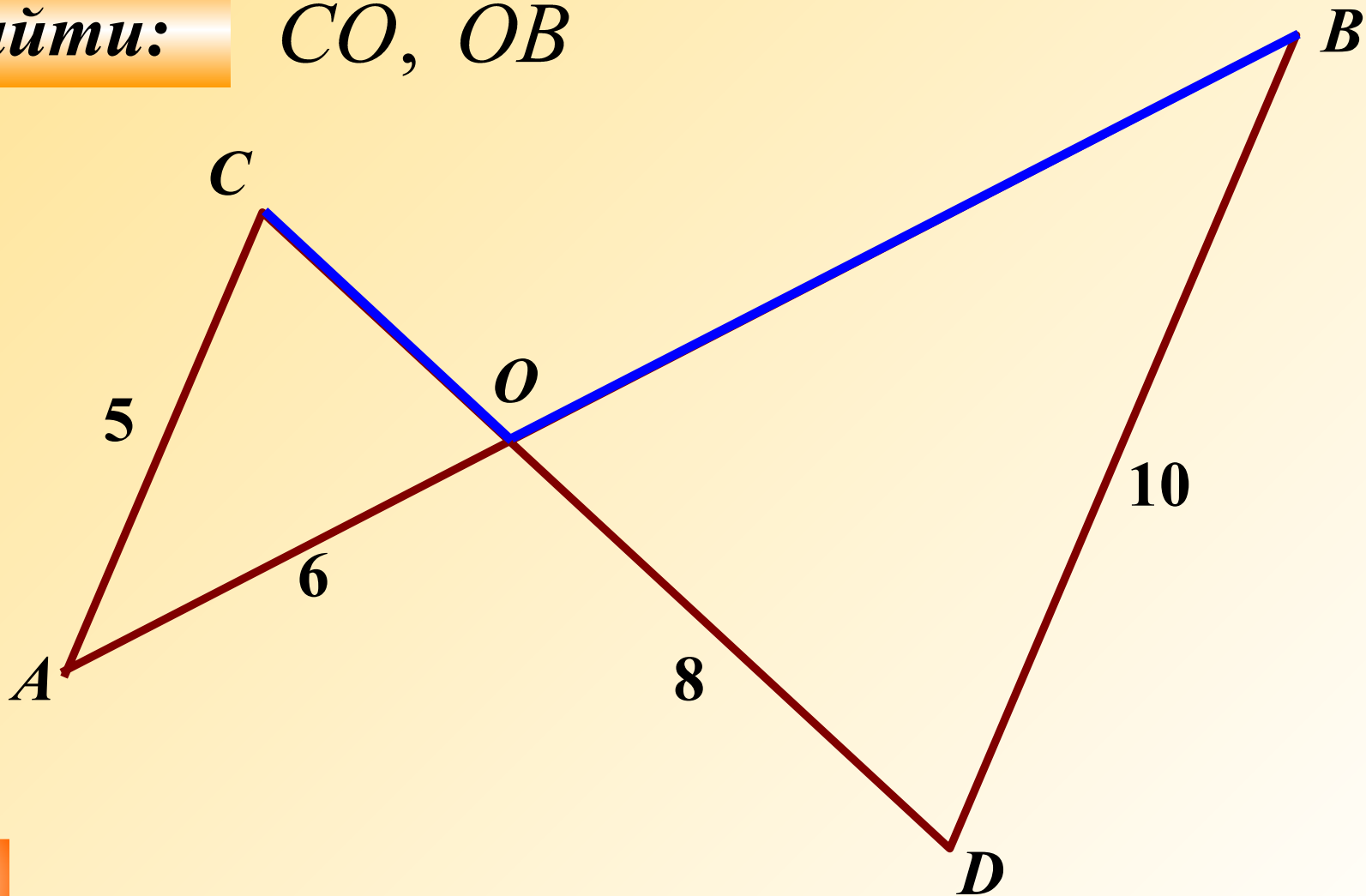

20.

Дано:

$\tilde{N}A\hat{I}A\hat{E}I\hat{I}A\hat{F}$

$$CA + AF + AE = 21$$

Найти:

$\tilde{N}A$, $A\hat{E}$, $A\hat{F}$

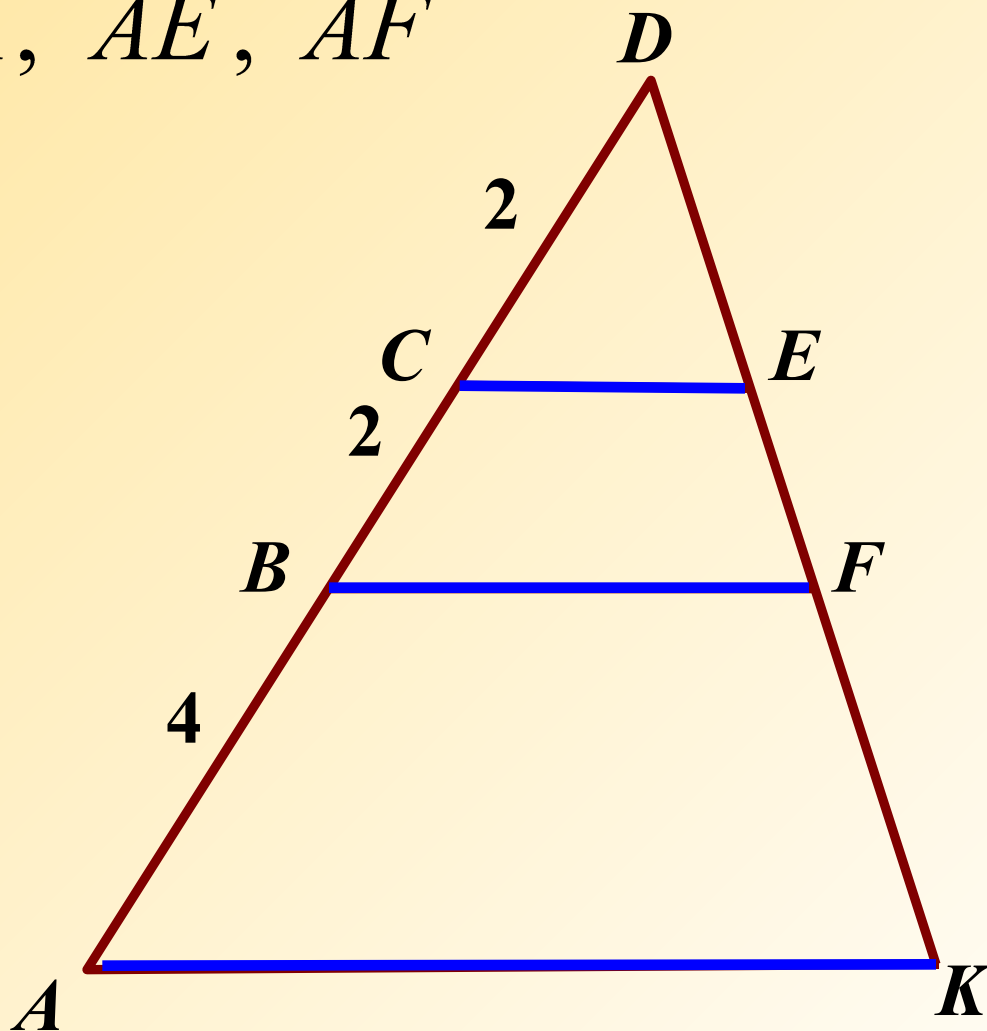

21.

Дано:

$ABCD$ – о́дàïàöèÿ

Найти:

$$\frac{S_{\triangle ABC}}{S_{\triangle ANM}}$$

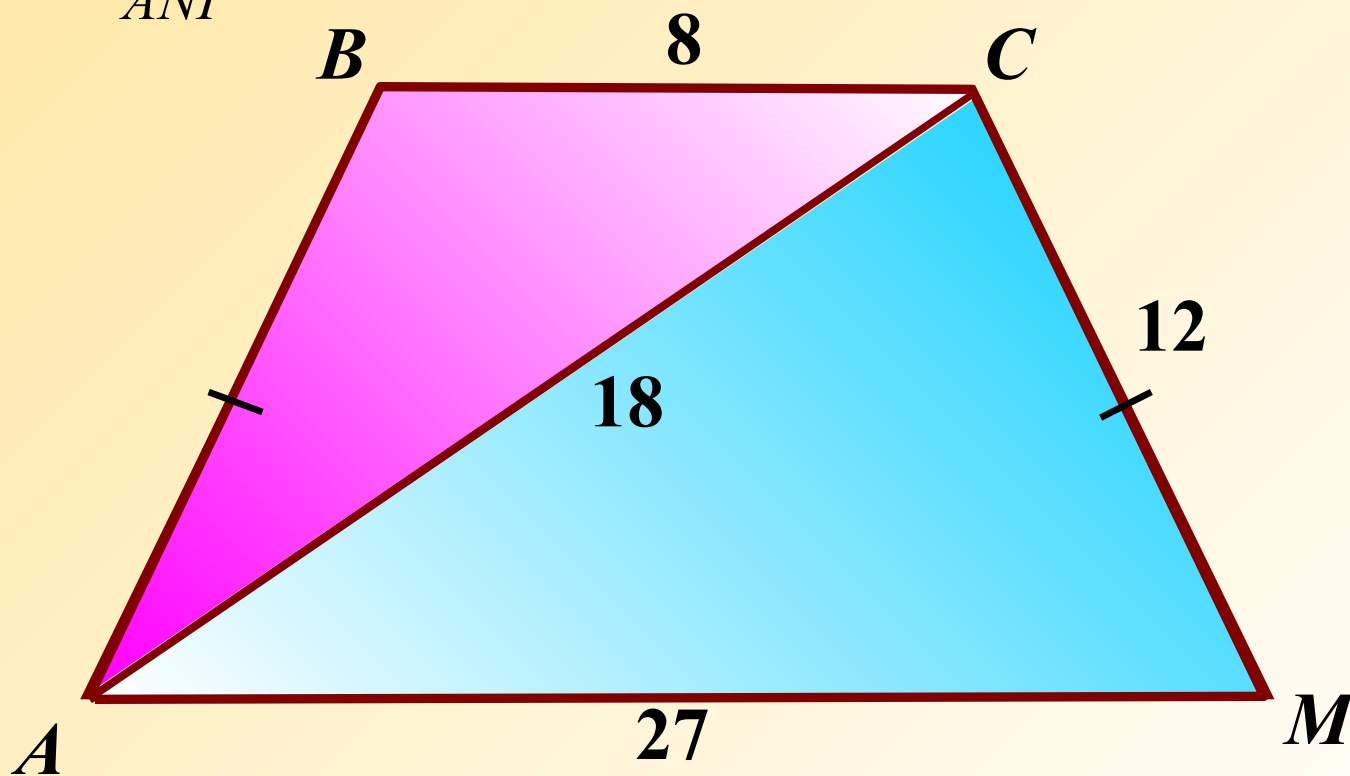

22.

Дано:

$$\triangle \hat{I} \hat{E} \hat{D}, \triangle \hat{A} \hat{I} \hat{I} \hat{D}$$

$$\hat{E} \hat{I} = \hat{I} \hat{D}, \hat{A} \hat{A} = 18$$

Найти:

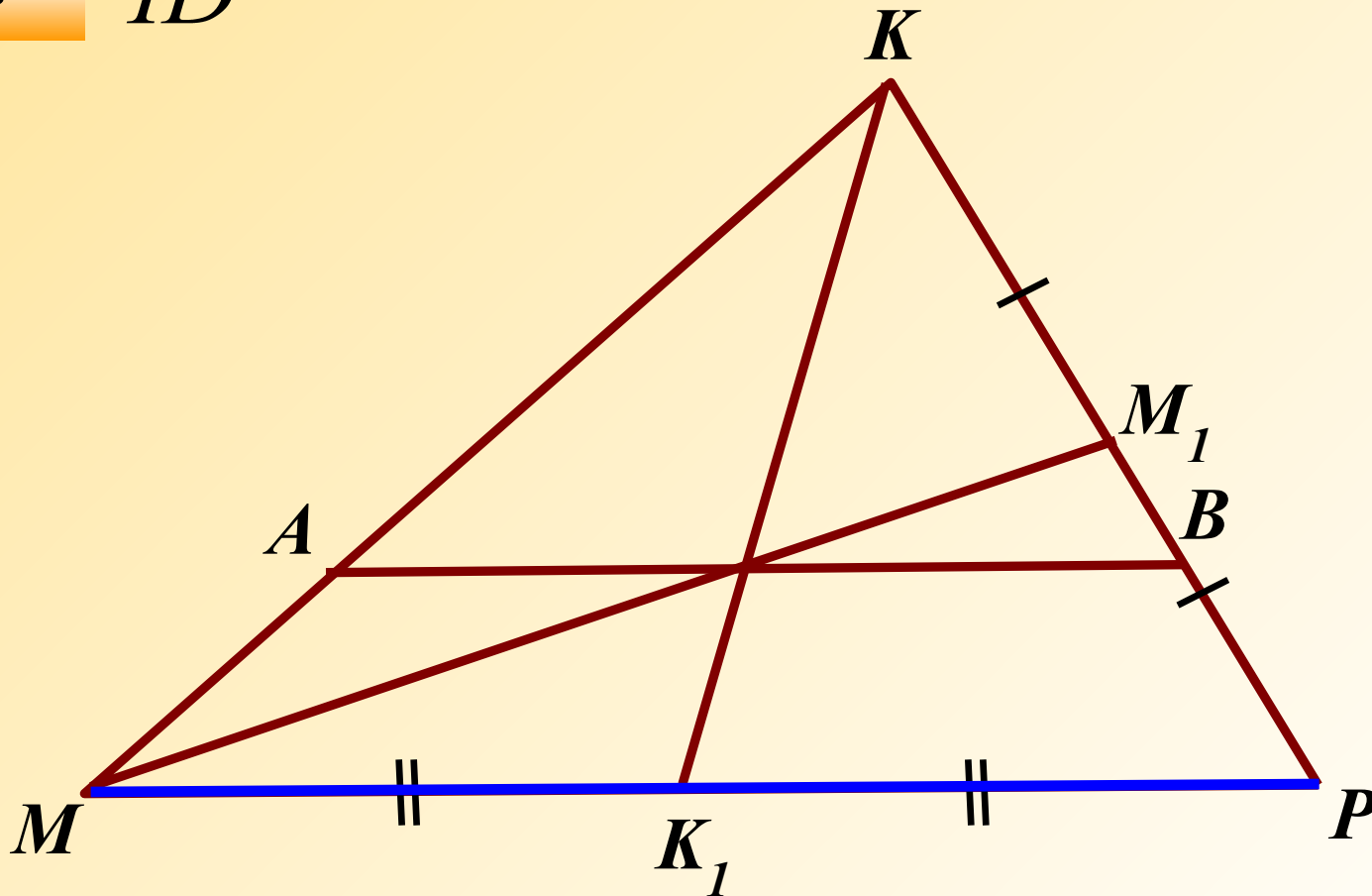
 $\hat{I} \hat{D}$ 

23.

Дано:

$\triangle MND$ – $\triangle ABC$

$$MN = 10 \text{ см}$$

Найти:

CF

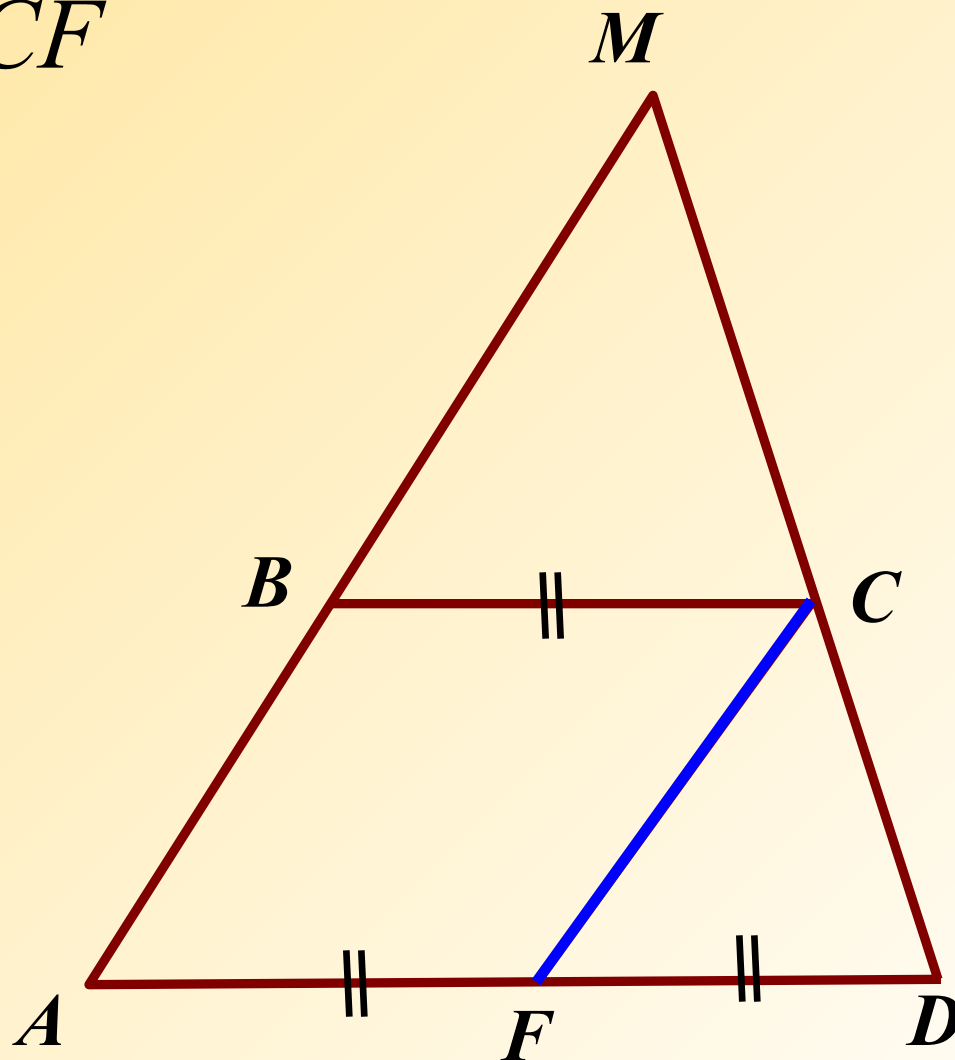

24.

Дано:

$$S_{ASD} = 16, AB = BD$$

Найти:

$$S_{BCS}$$

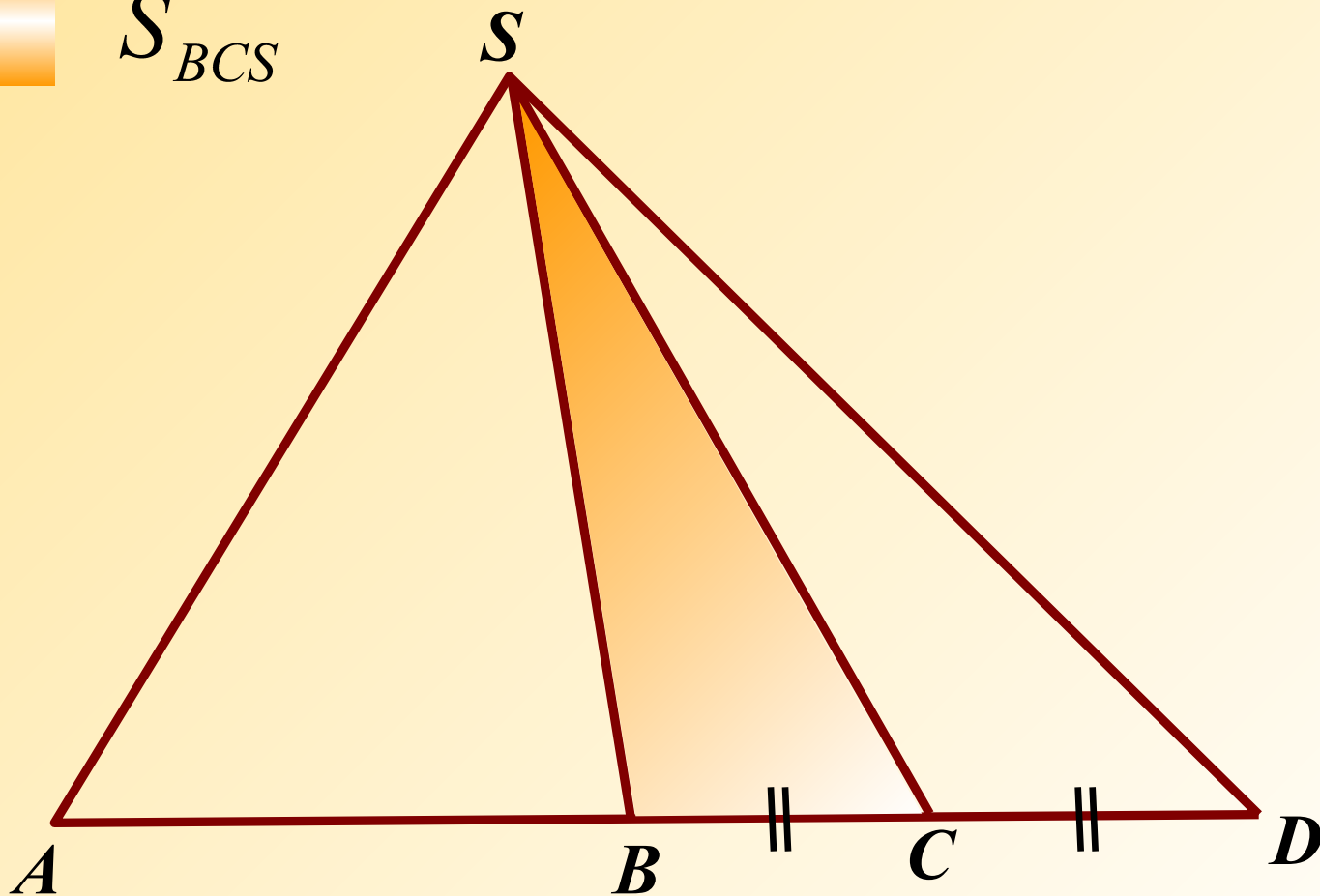

25.

Дано:

$\triangle ABC$, $AB = 10$, $AC = 14$

Найти:

S_{BOC}

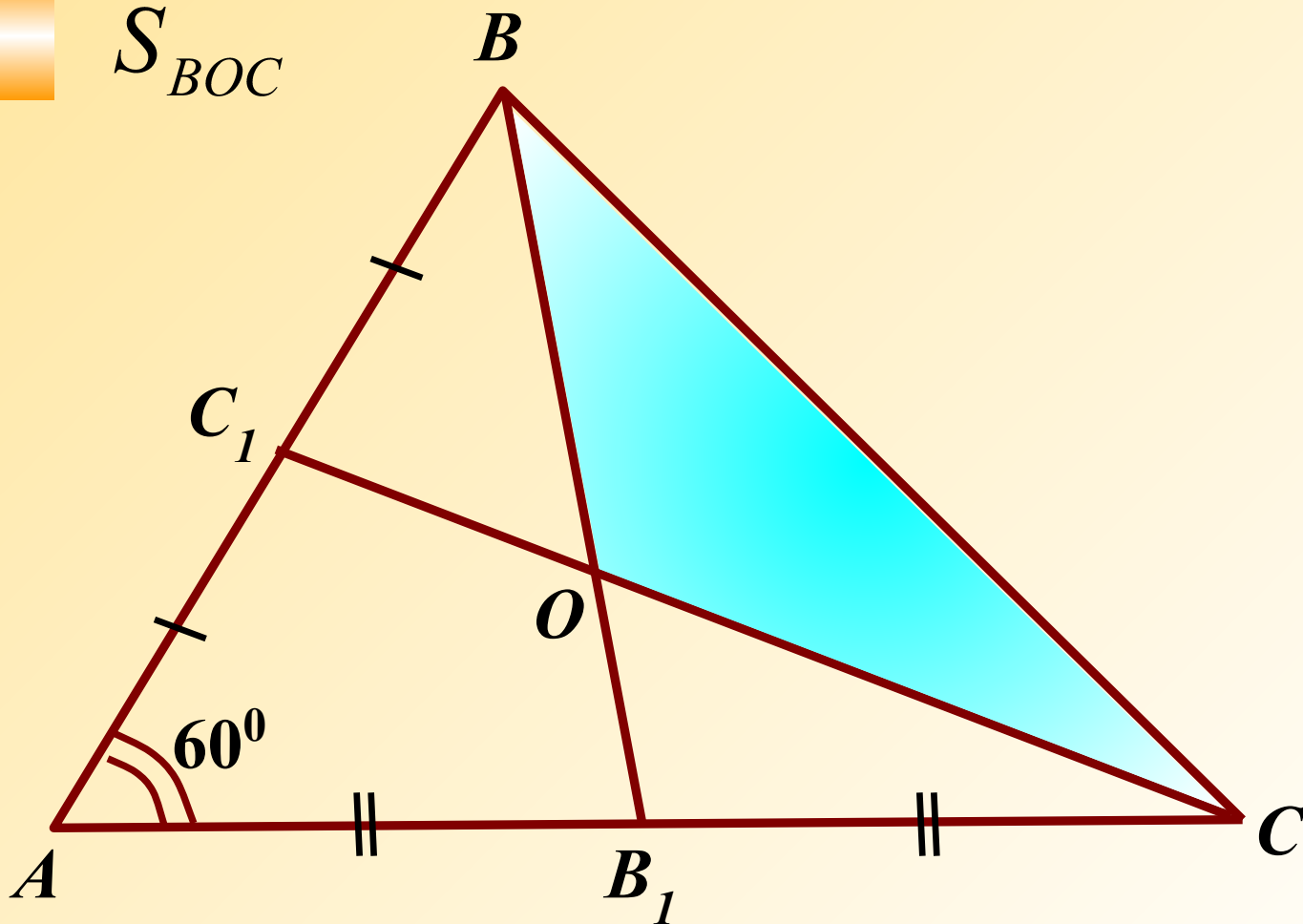

26.

Дано: $\triangle ABC$

Найти:

\hat{A}

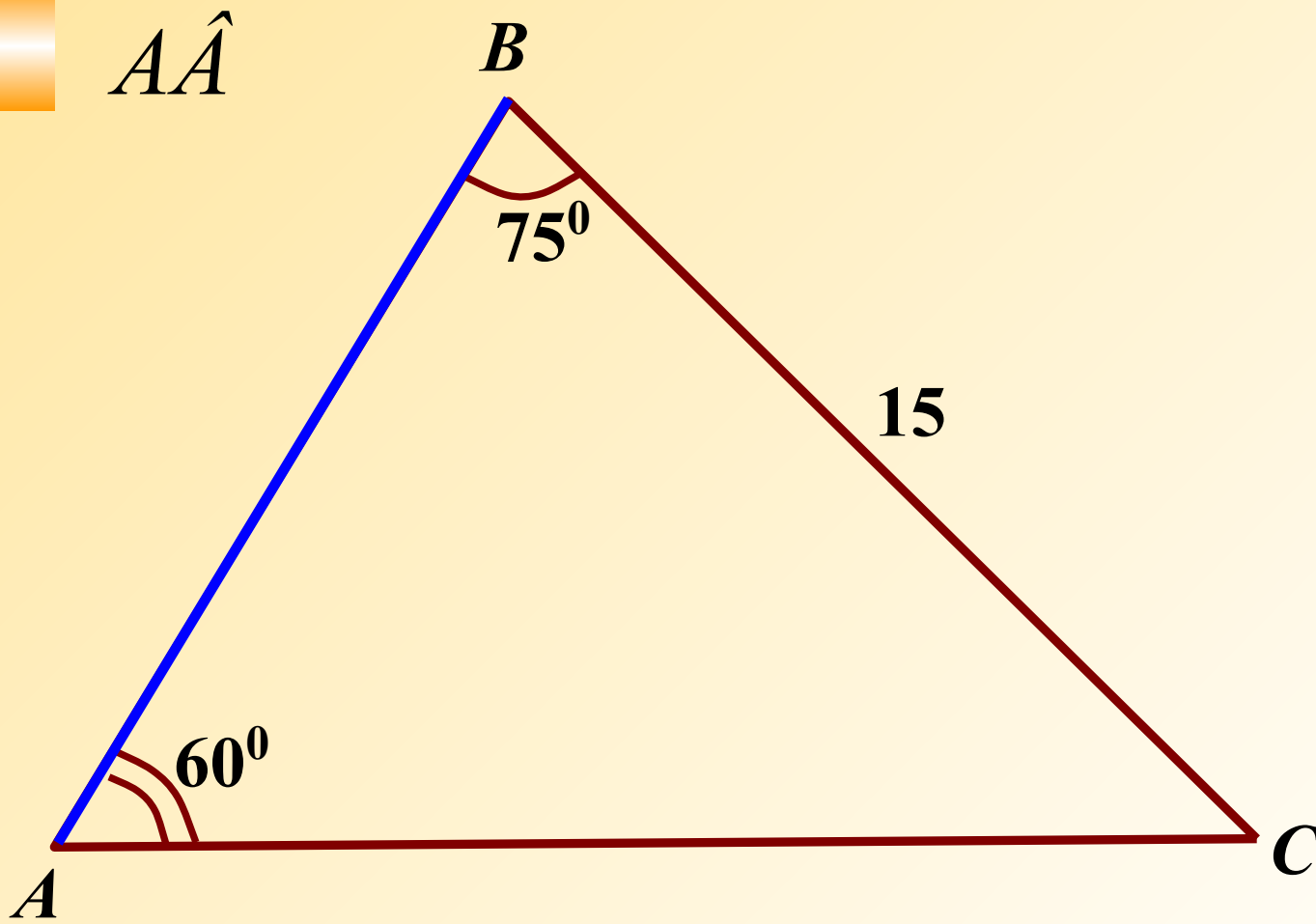

27.

Дано:

$\triangle CDE$, $DE > CD \hat{=} 2,5$ ðàçà

Найти:

$$\frac{\tilde{N}A}{\tilde{N}D}$$

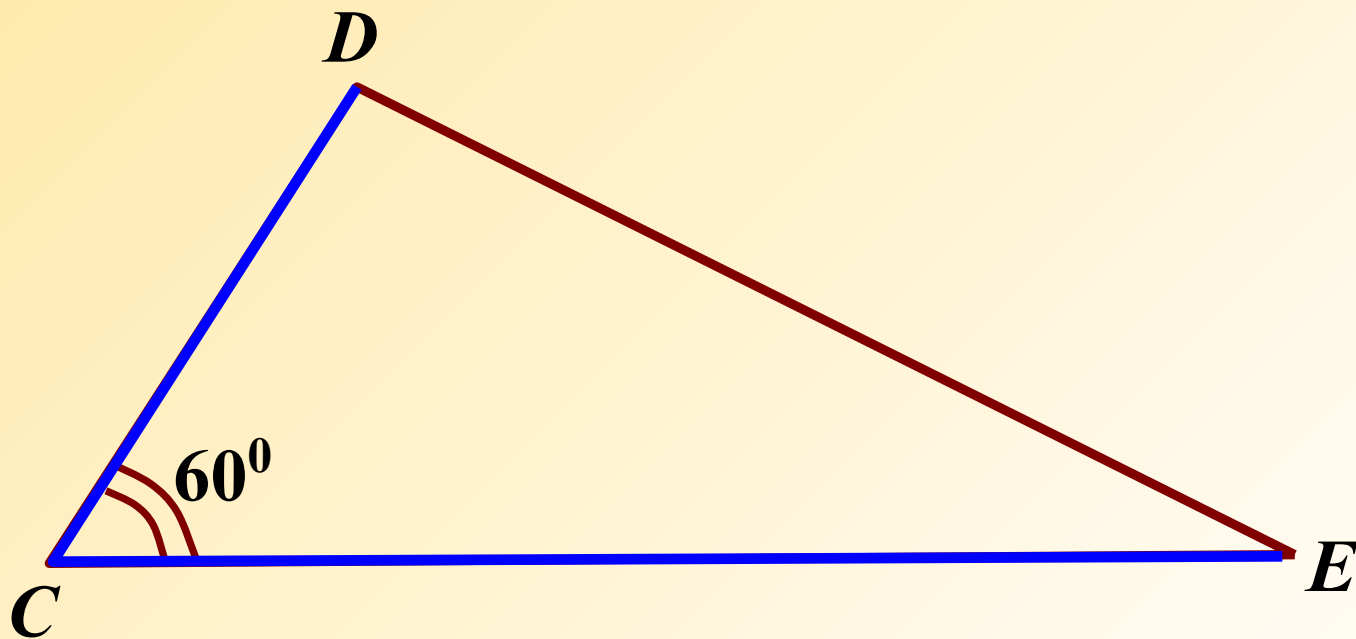

28.

Дано:

$$AB \cdot BK = CB \cdot BP$$

Найти:

$\angle A$, $\angle C$

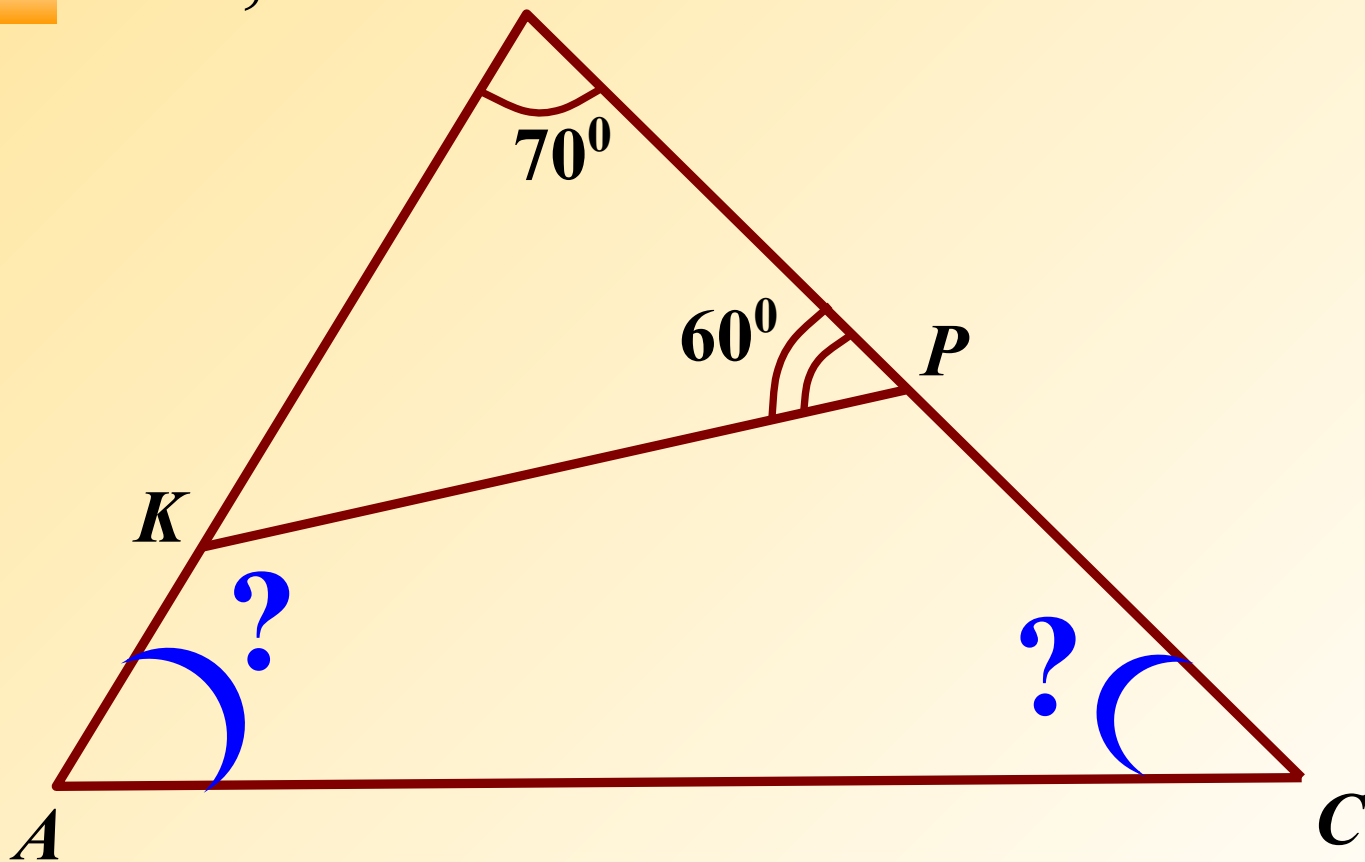

29.

Дано:

$\triangle ABC$, $AC = 8$

Найти:

PC

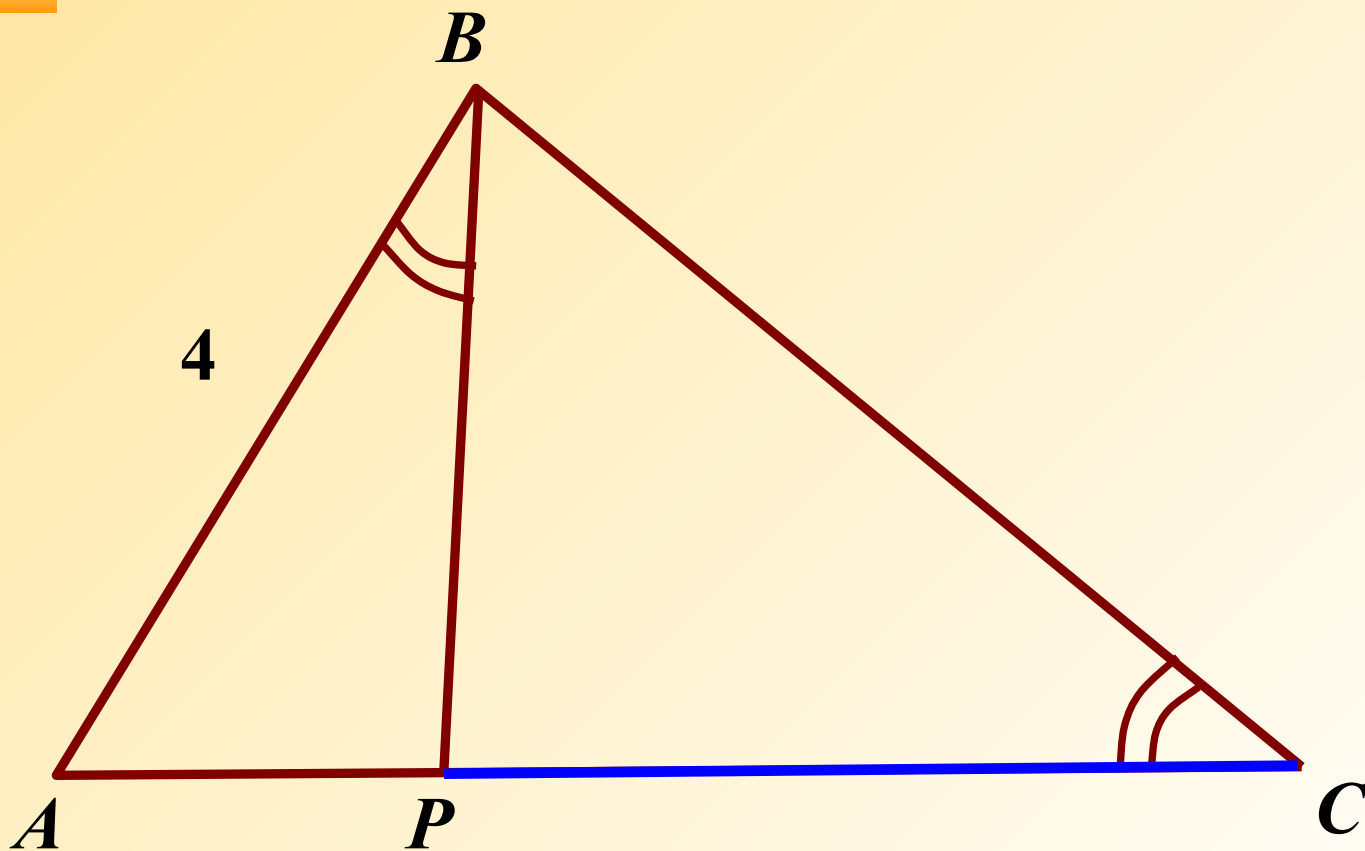

30.

Дано: $\triangle ABC$

Найти: OC

