

*Решение задач
на готовых чертежах.*

*Прямоугольный
треугольник.*

Геометрия.

8 класс.

*Каратанова Марина Николаевна
МОУ СОШ №256 г.Фокино*



1

2

3

4

5

6

7

8

9

10

11

12

13

14

15

16

17

18

19

20

21

22

23

24

25

26

27

28

29

30

1.

Дано: $\triangle ABC$

Найти:

$\sin B$, $\cos B$, $\operatorname{tg} B$

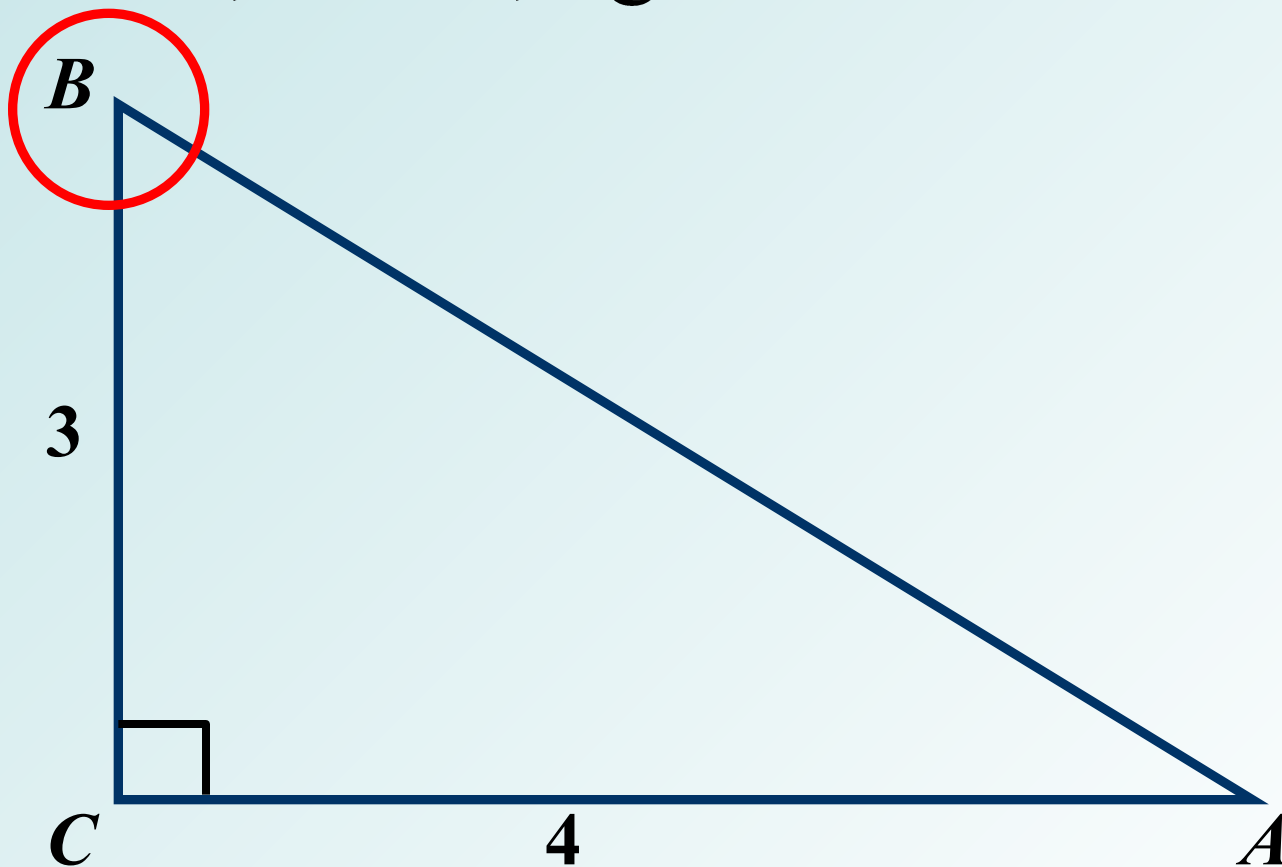

2.

Дано:

$\triangle ABC$, $\hat{A} = 8$

Найти:

S_{ABC}

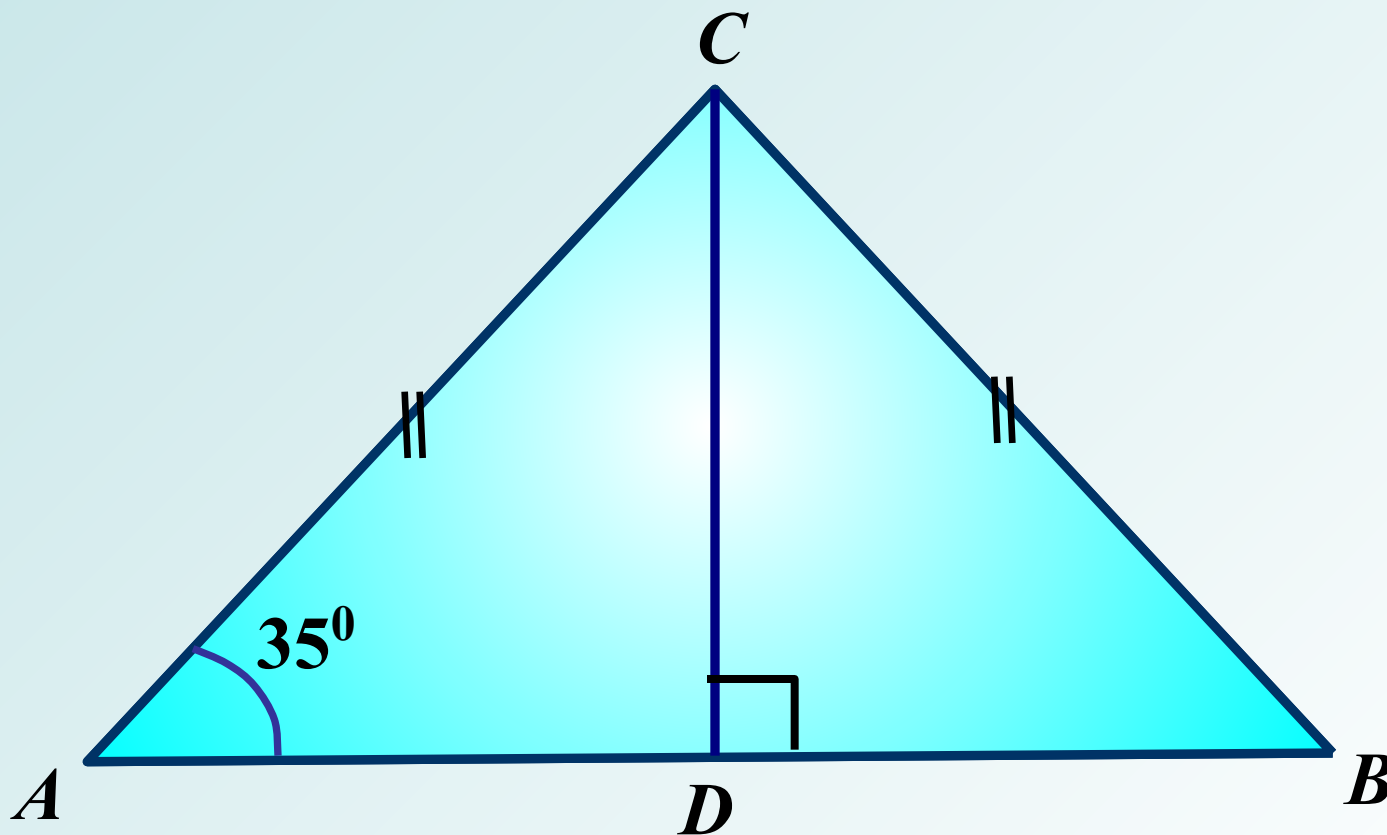

3.

Дано: $ABCD$ – $\text{ïðÿ\grave{u}\grave{i}\hat{o}\grave{a}\tilde{i}\grave{e}\grave{u} \quad \acute{i}\grave{e}\acute{e}$

Найти: $\hat{A}\tilde{N}$, $\hat{A}D$

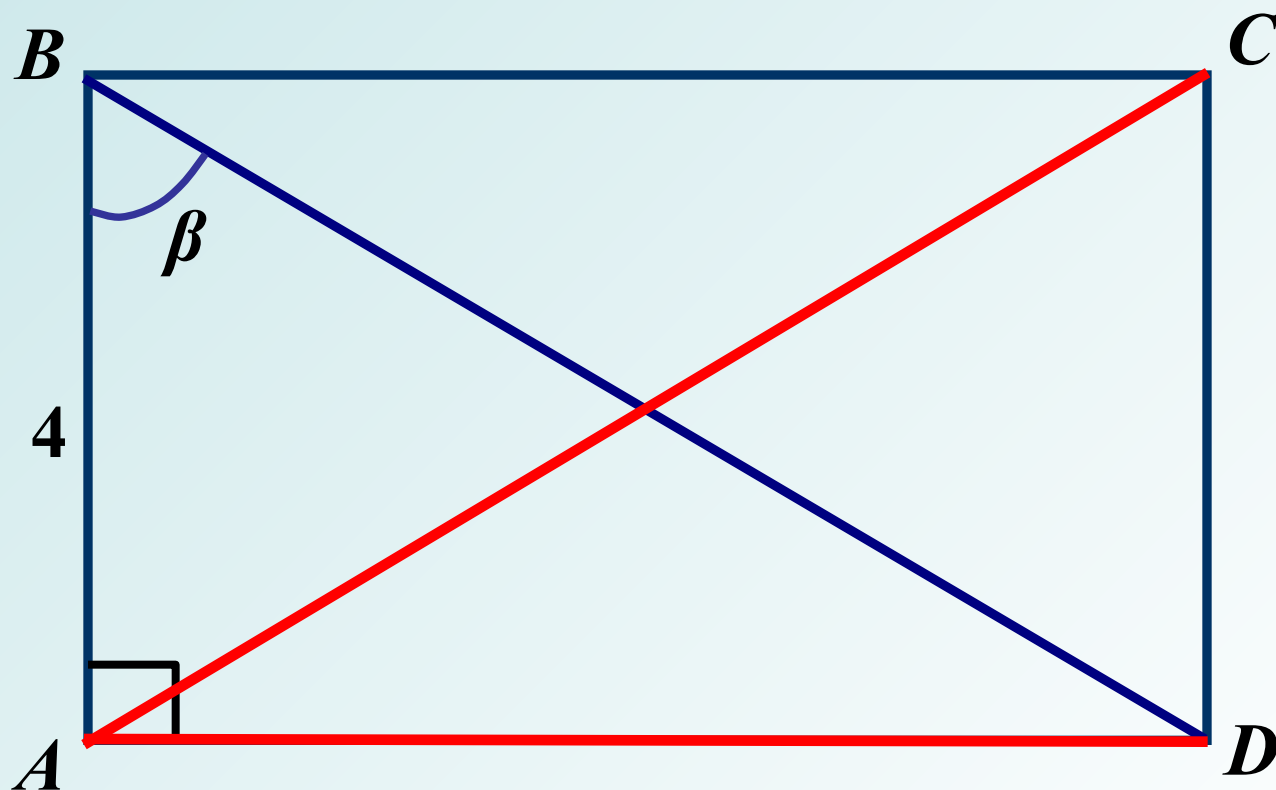

4.

Дано: $ABCD$ – òđàìäöèÿ

Найти: AD , CD , $S_{A\hat{A}ND}$

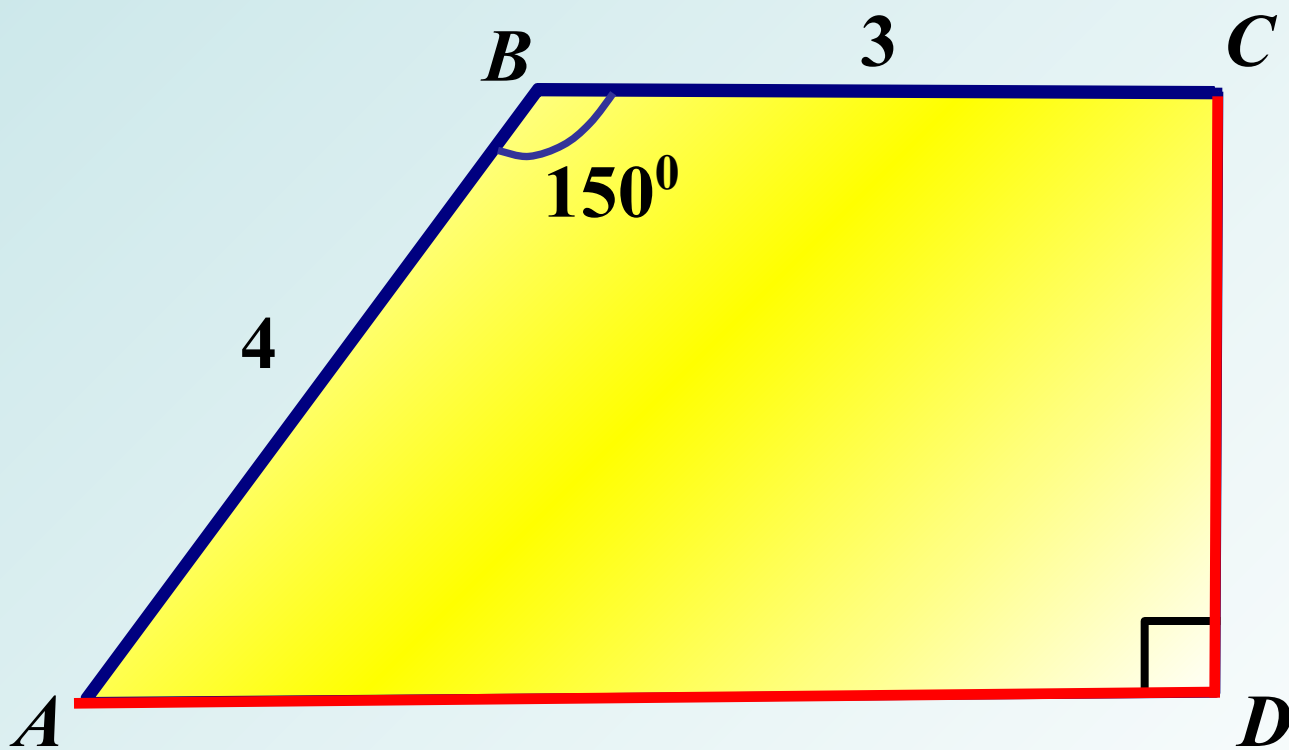

5.

Дано: $ABCD$ – $òđàìäöëÿ$

Найти:

$\angle A$, $\angle B$

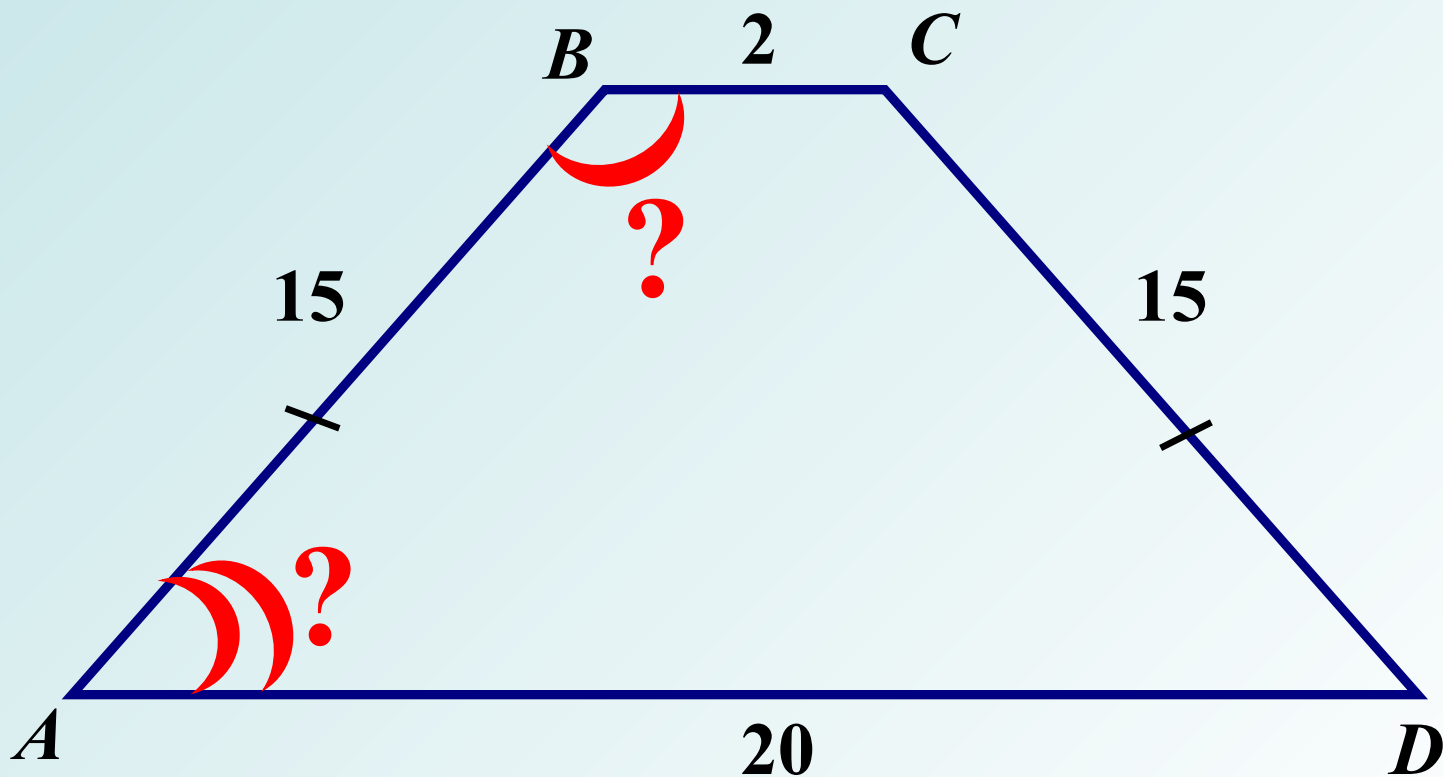

6.

Дано: $\triangle ABC$

Найти:

AN

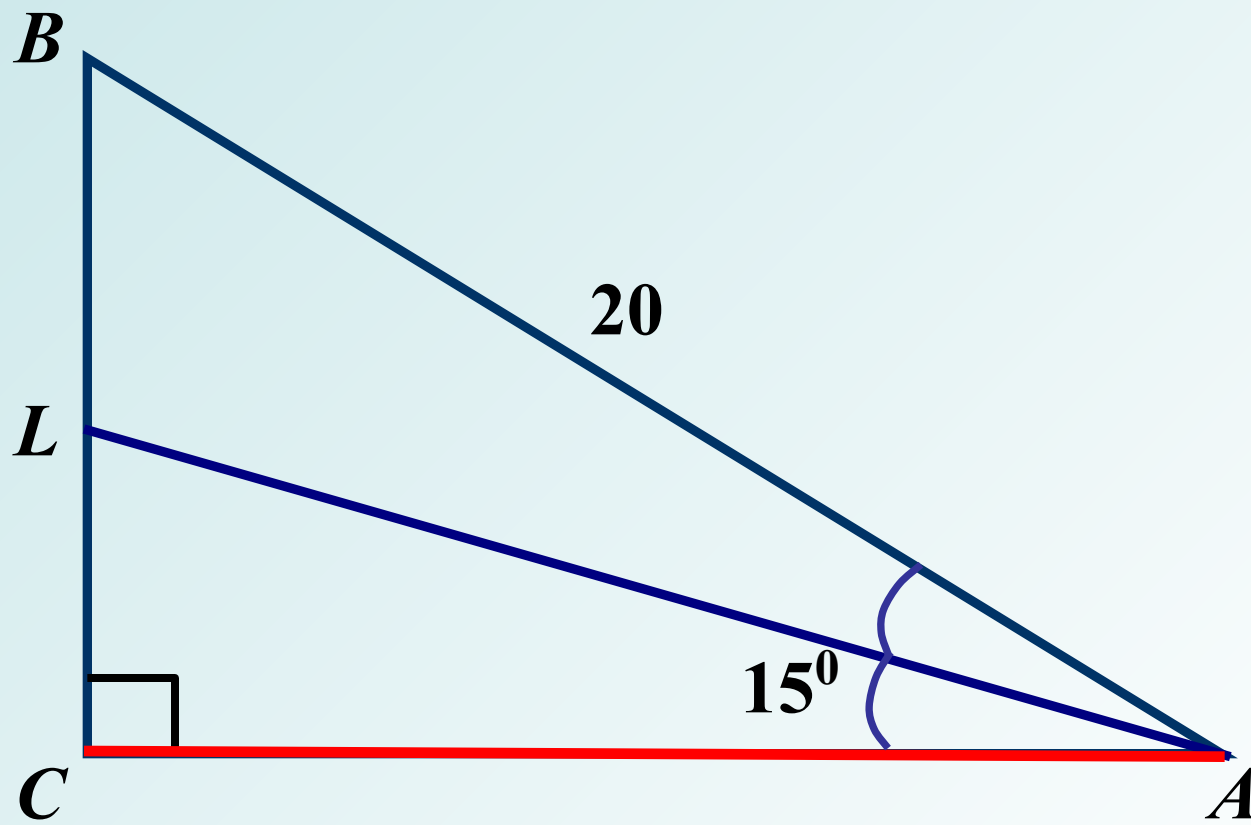

7.

Дано: $ABCD$ – трапеция

Найти:

S_{ABCD}

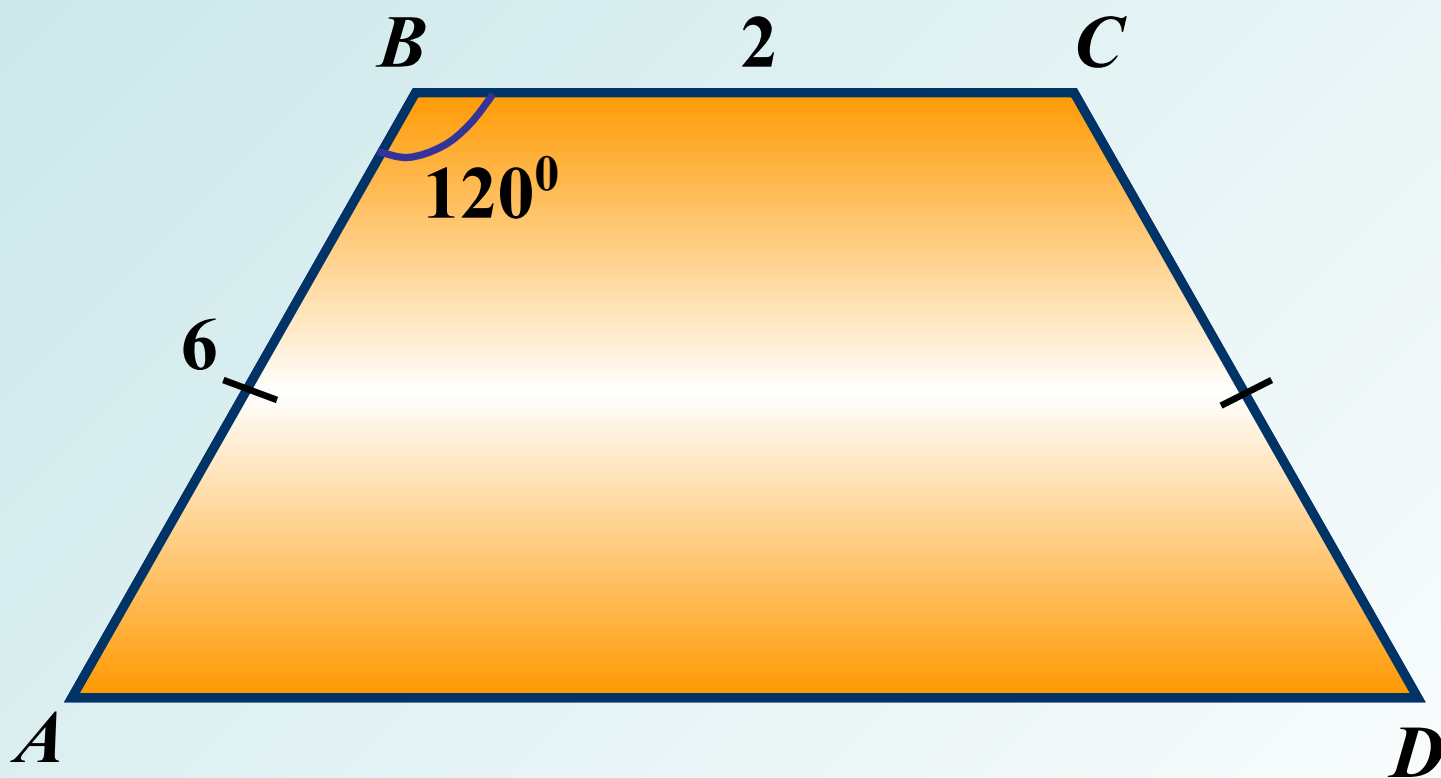

8.

Дано: $\triangle A\hat{A}\tilde{N}$

Найти: AD, AC

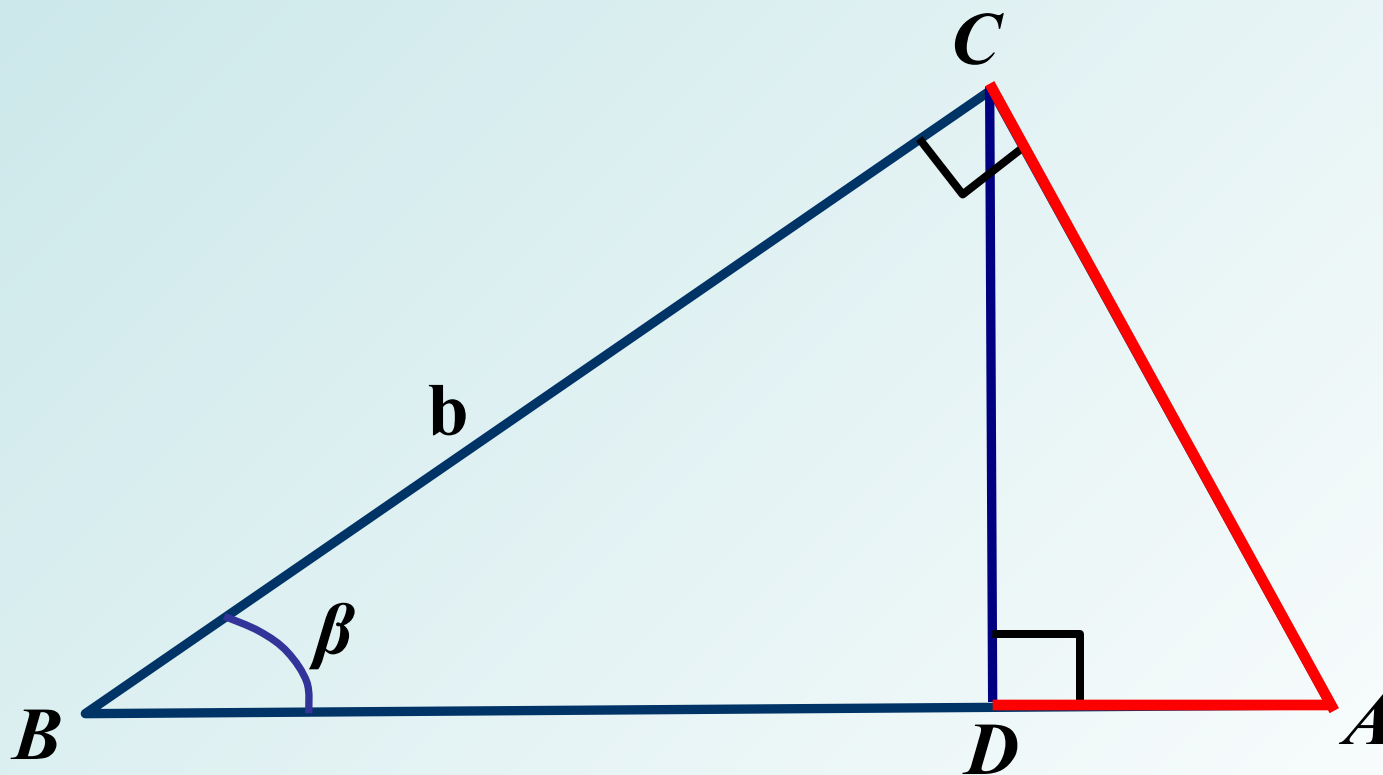

9.

Дано:

$AB\tilde{N}D$ – о́дàìàöèÿ

Найти:

AD, S_{ABCD}

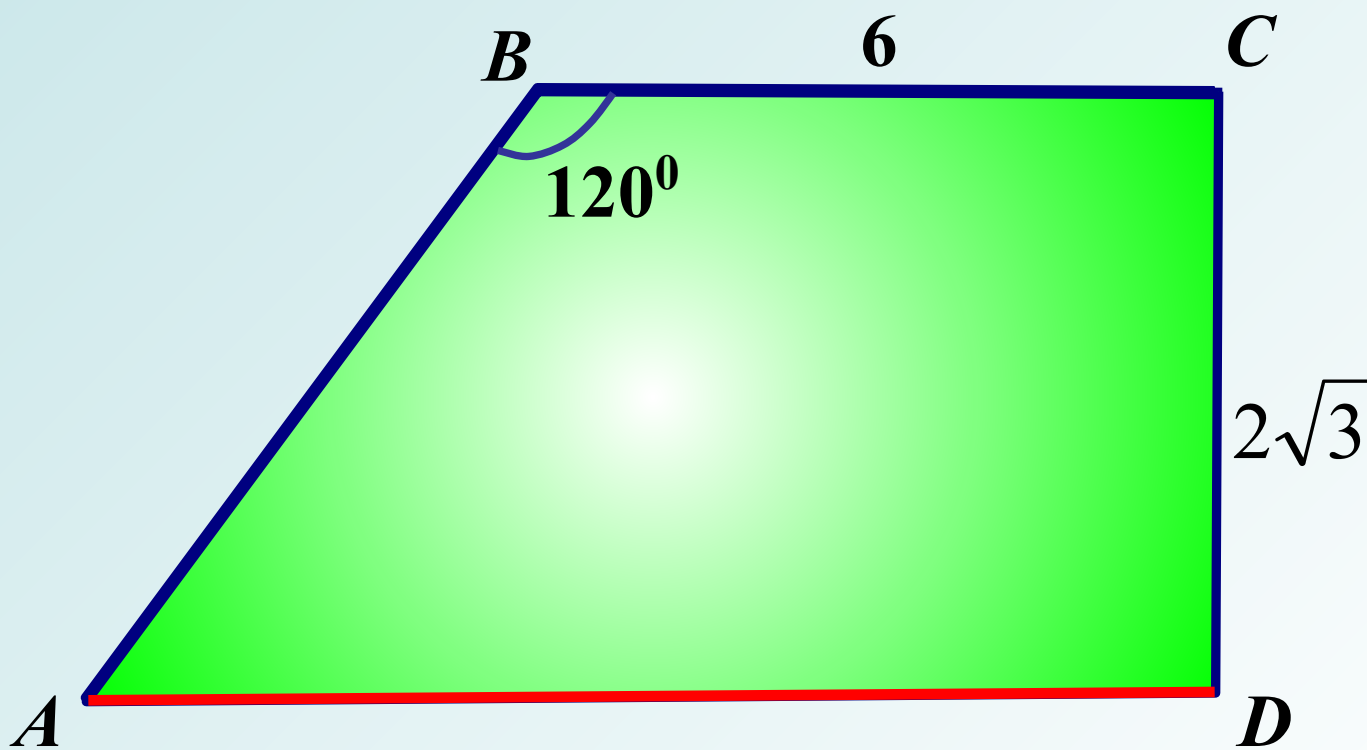

10.

Дано:

$$\triangle ABC, \cos B = \frac{1}{3}, \hat{A} = 4$$

Найти:

\hat{E}

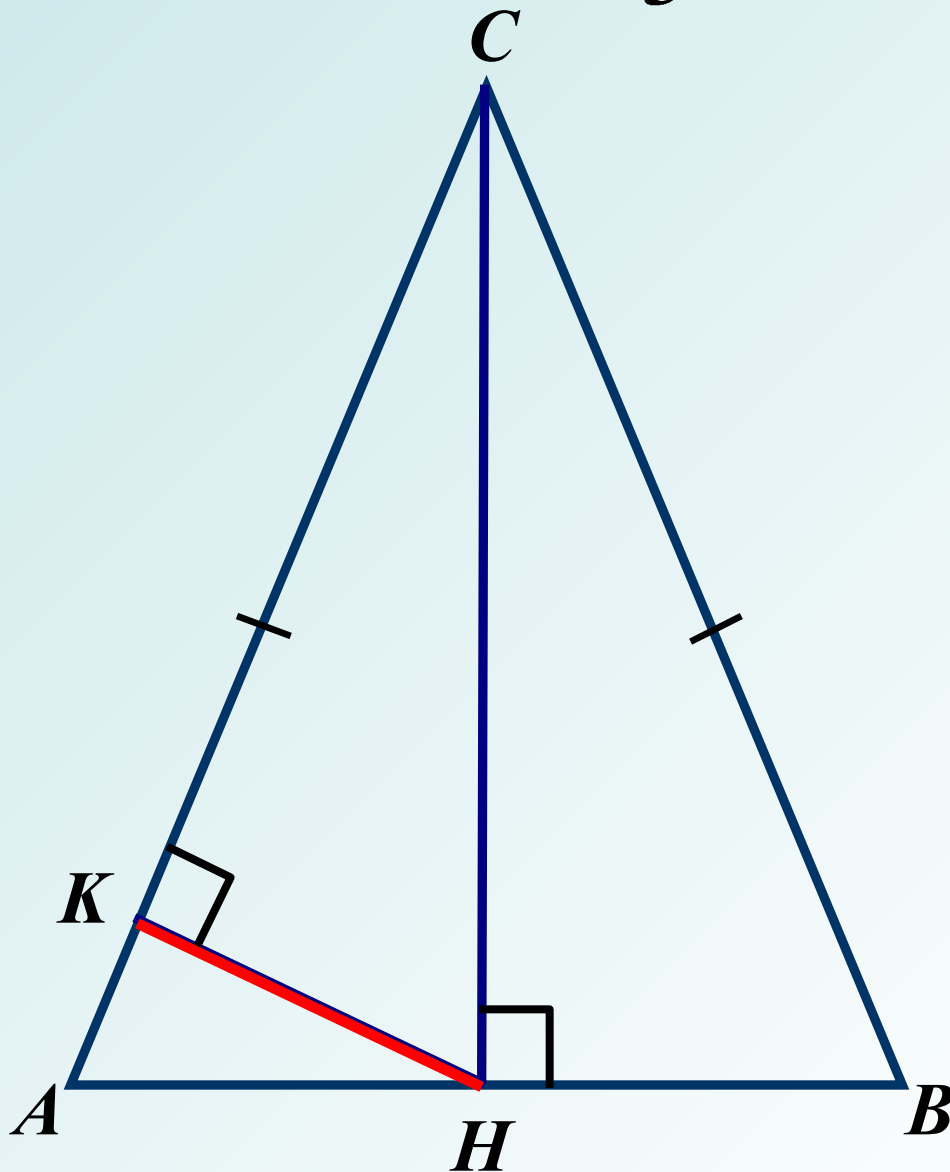

11.

Дано: $\triangle A\hat{A}C$

Найти: BD

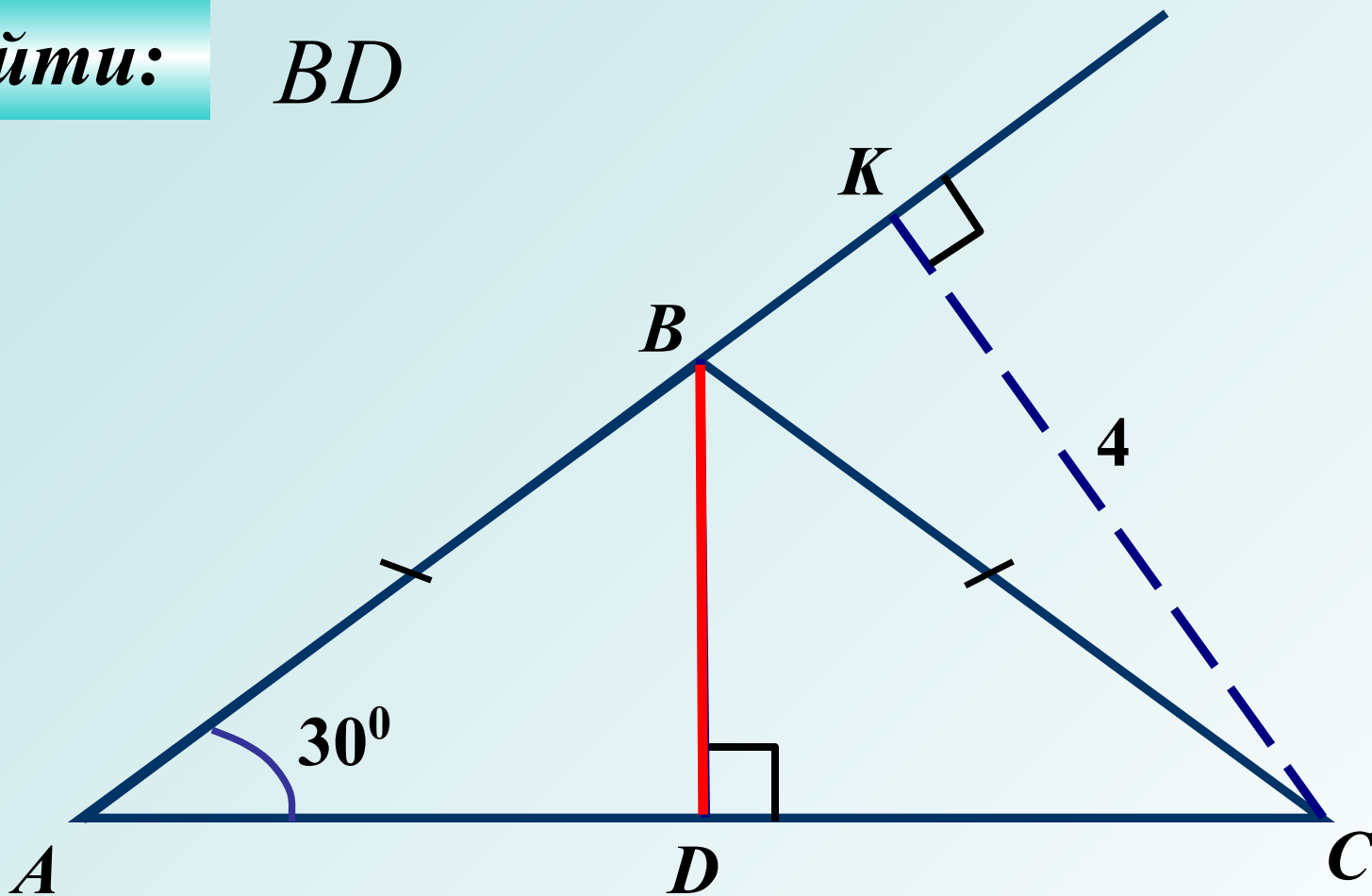

12.

Дано:

$ABCD$ – \triangle , $\angle B = 90^\circ$, $\angle C = 90^\circ$

Найти:

AD

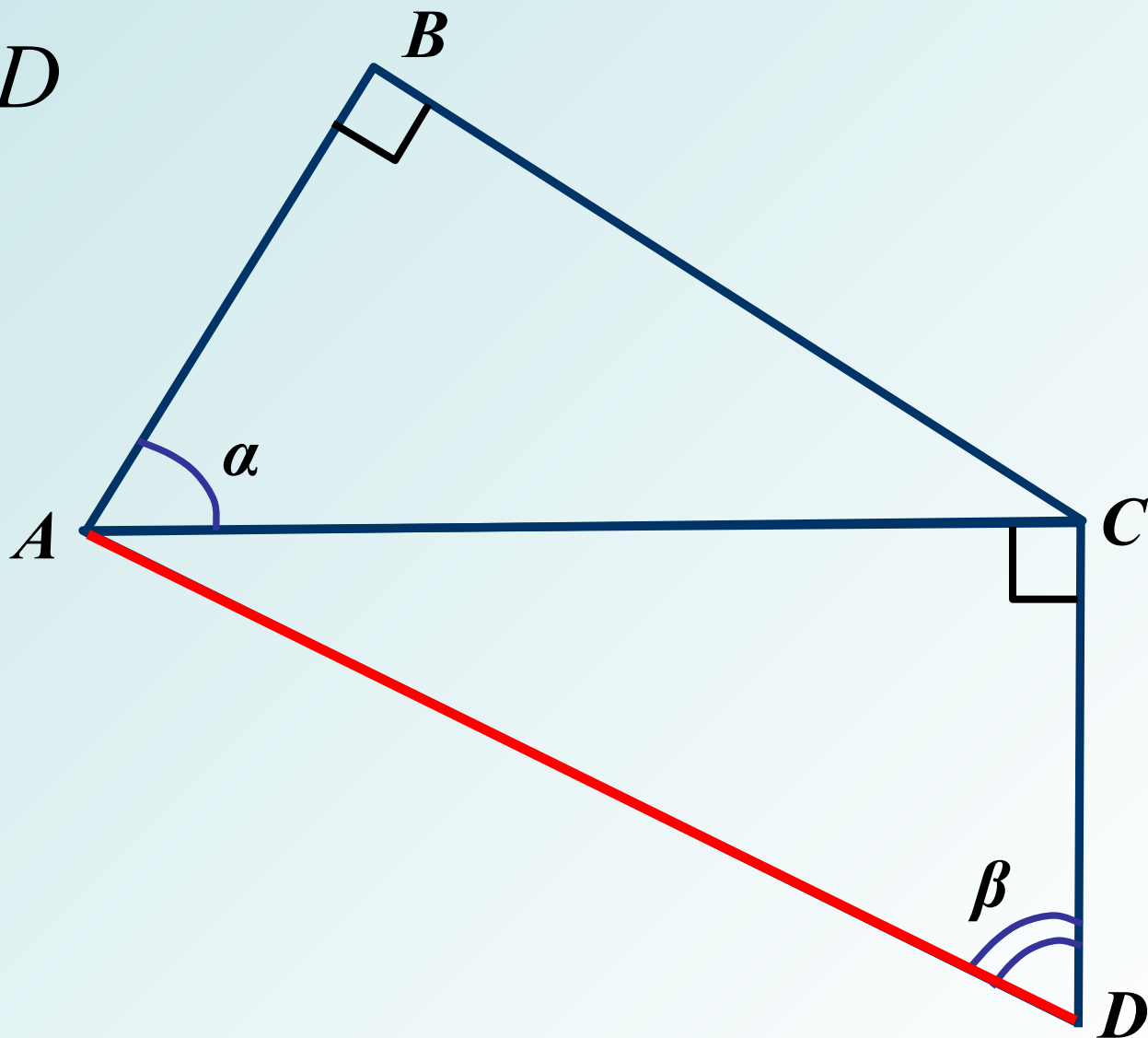

13.

Дано: $\triangle ABC$

Найти: BC , AC , $S_{A\hat{A}C}$

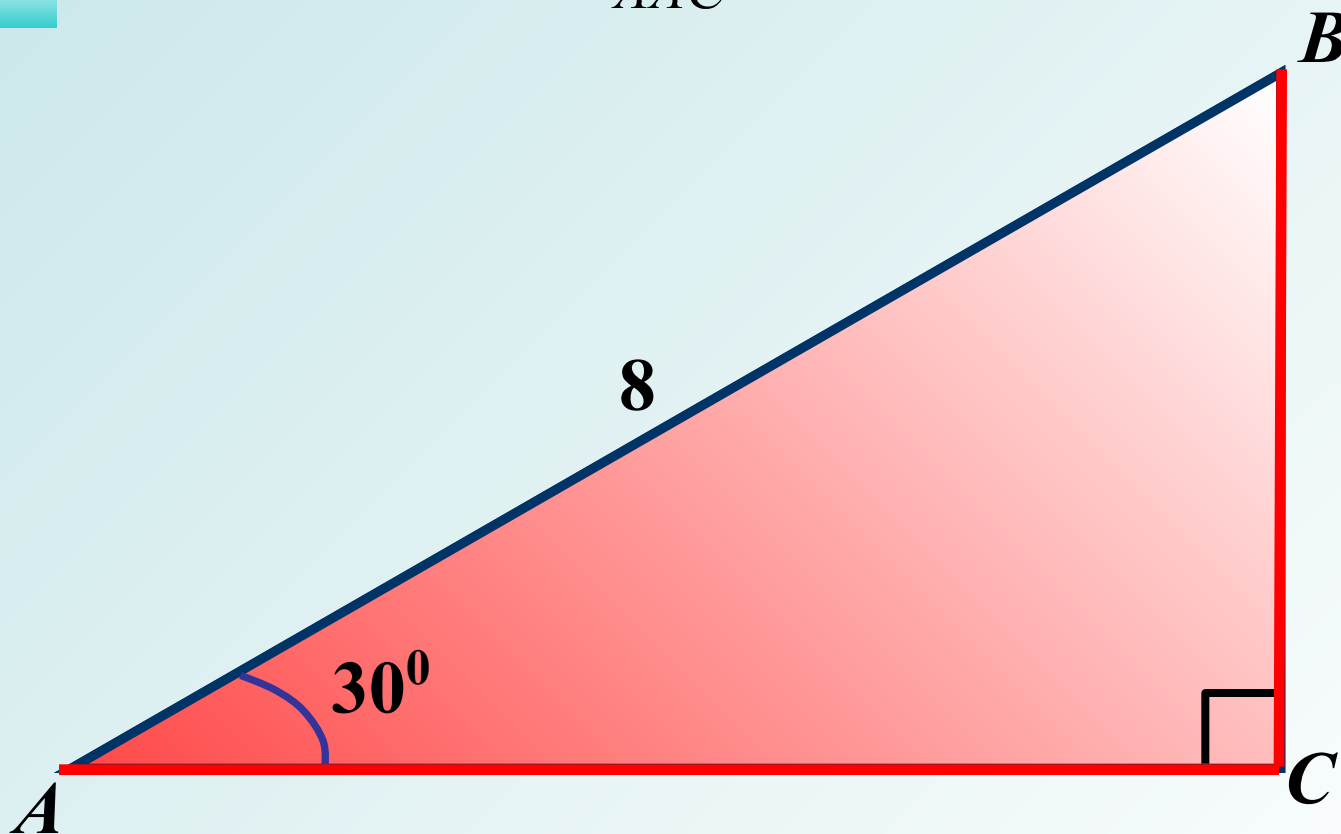

14.

Дано: $\triangle MKN$

Найти: MK, MN

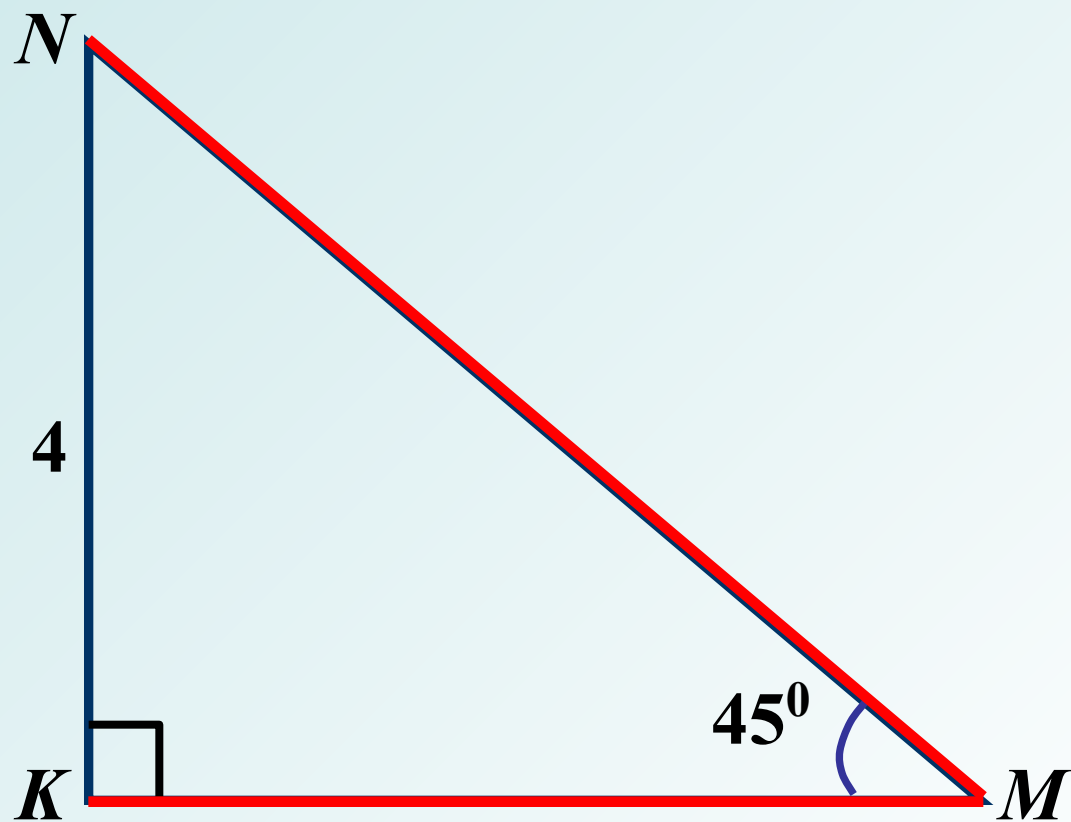

15.

Дано: $\triangle MPE$, $ME = b$, $\angle MPE = \beta$

Найти: MP , PA

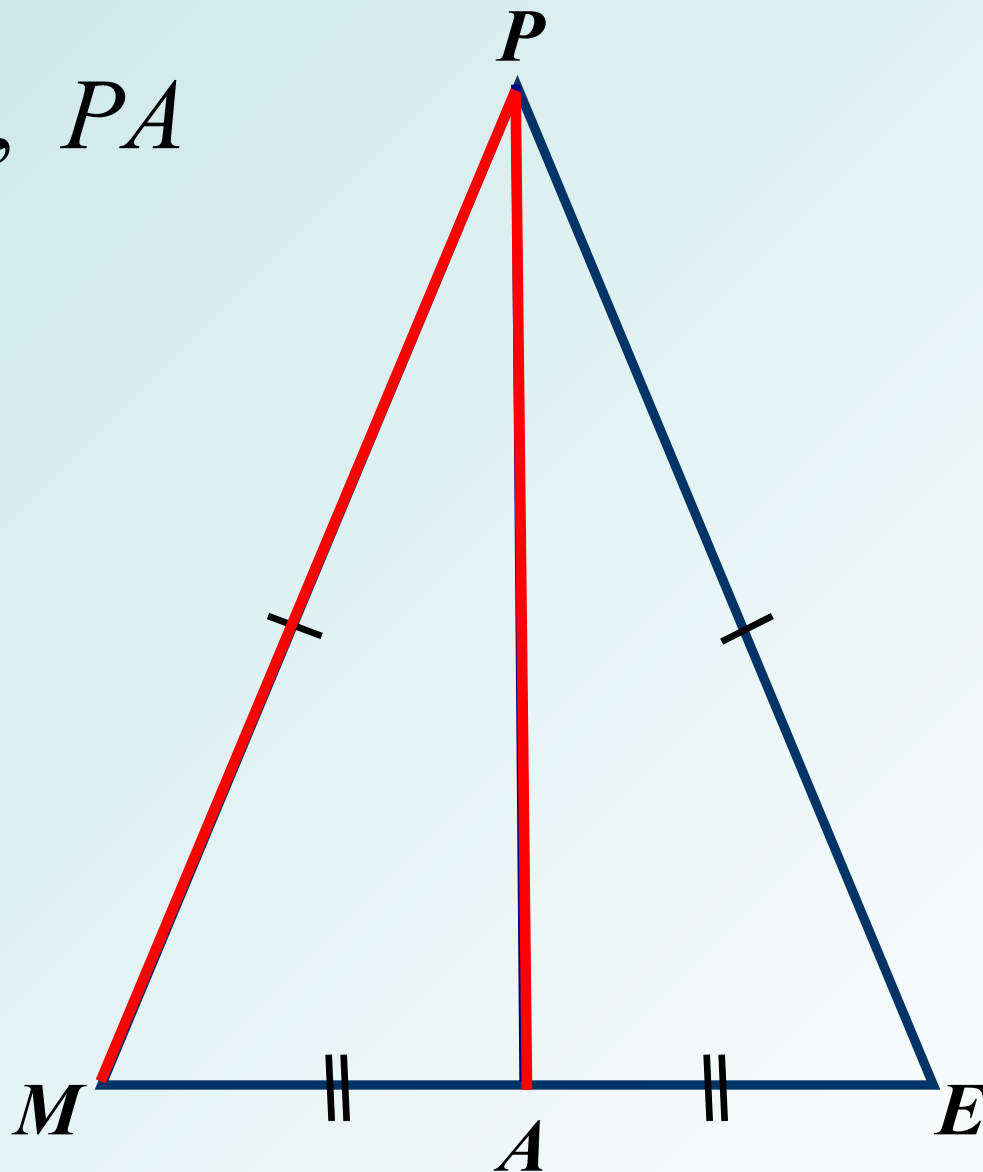

16.

Дано:

$\triangle ABC$, $\angle ABC = 60^\circ$

BF – *áèññáéòðèñà*

Найти: $\hat{A}F$

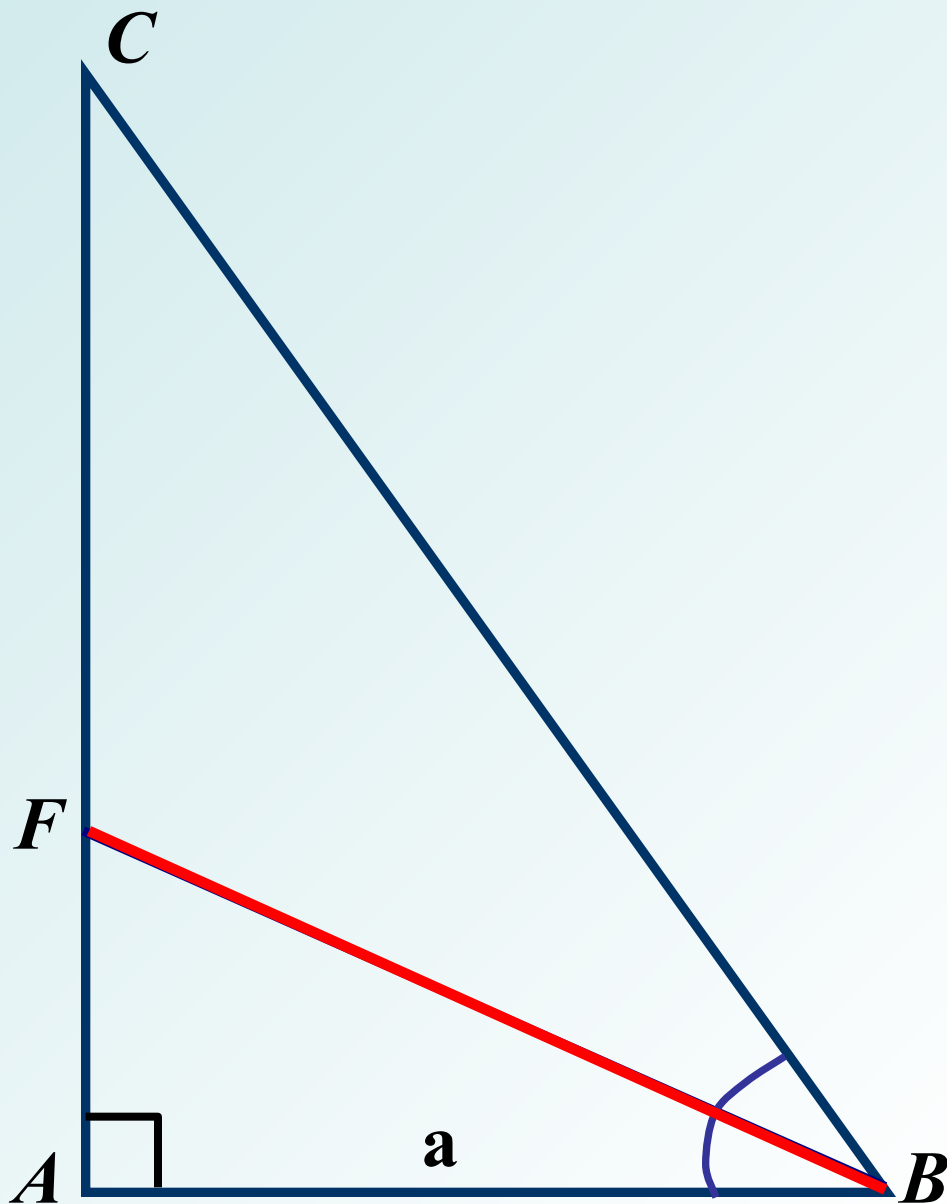

17.

Дано: $ABCD$ – прямоугольник $\angle A = 90^\circ$

Найти: CD , AC , S_{ABCD}

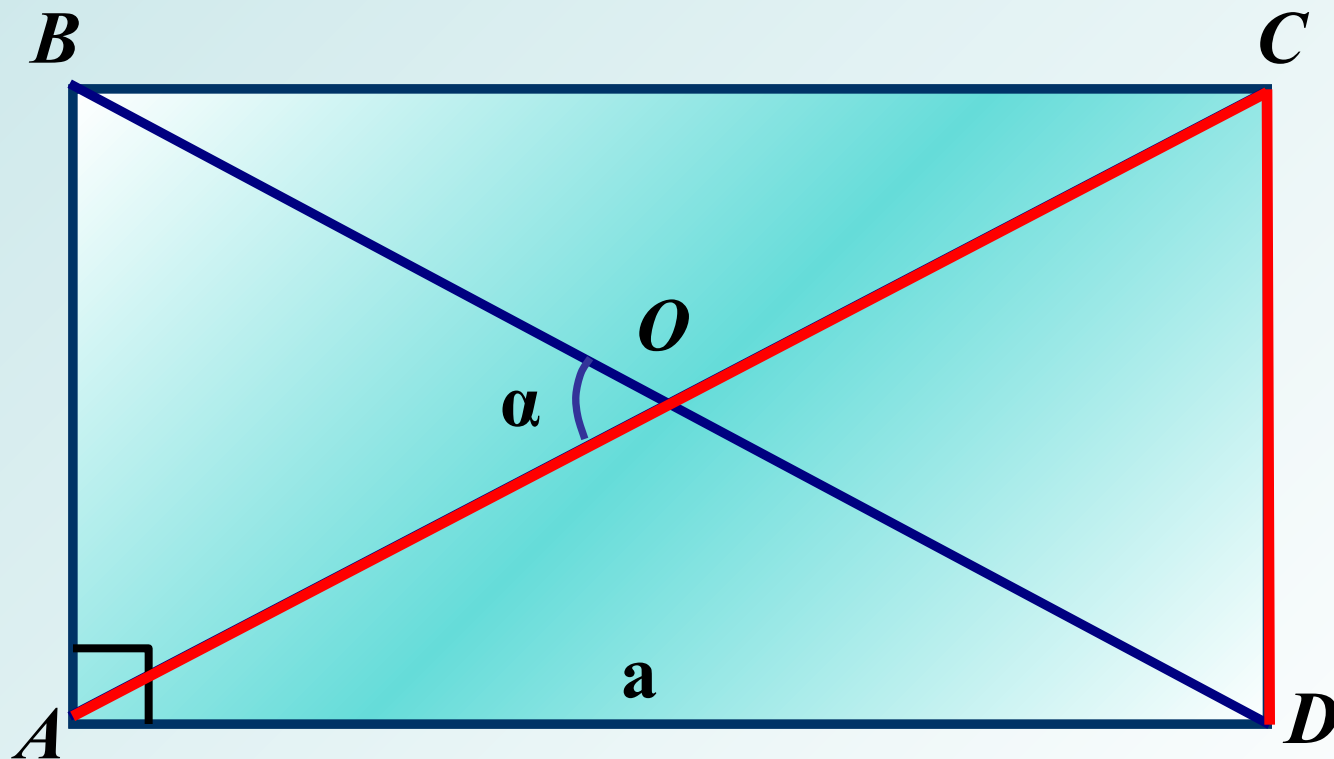

18.

Дано: $ABCD$ – \square

Найти: S_{ABCD}

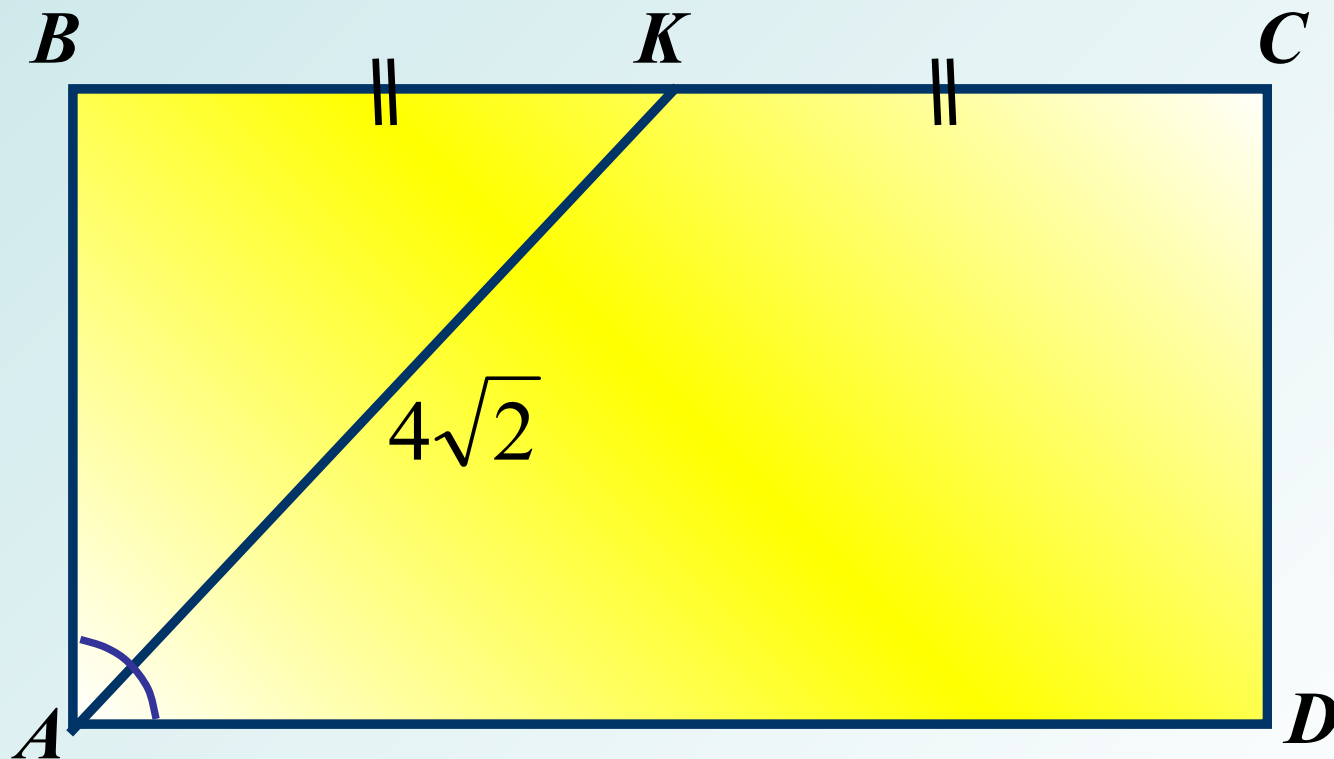

19.

Дано: $MN : MK = 5 : 3$, $AC + BC = 48$

Найти: MN , MK

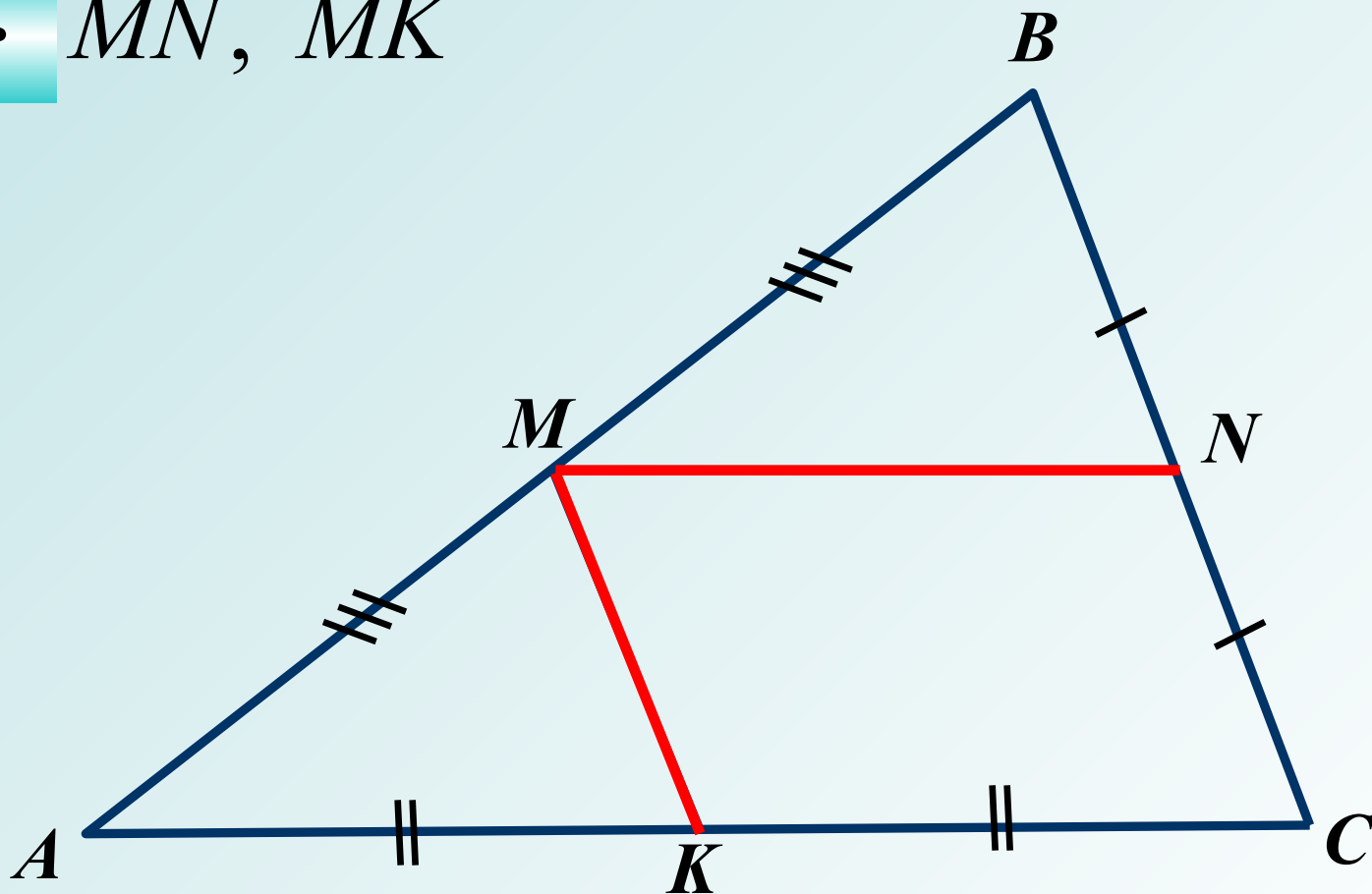

20.

Дано:

$ABM\hat{I}$ – $i\check{o}y\grave{i}\hat{i}o\check{a}\hat{i}e\ddot{u}$ $i\grave{e}\hat{e}$

Найти:

$\hat{A}\hat{I}$

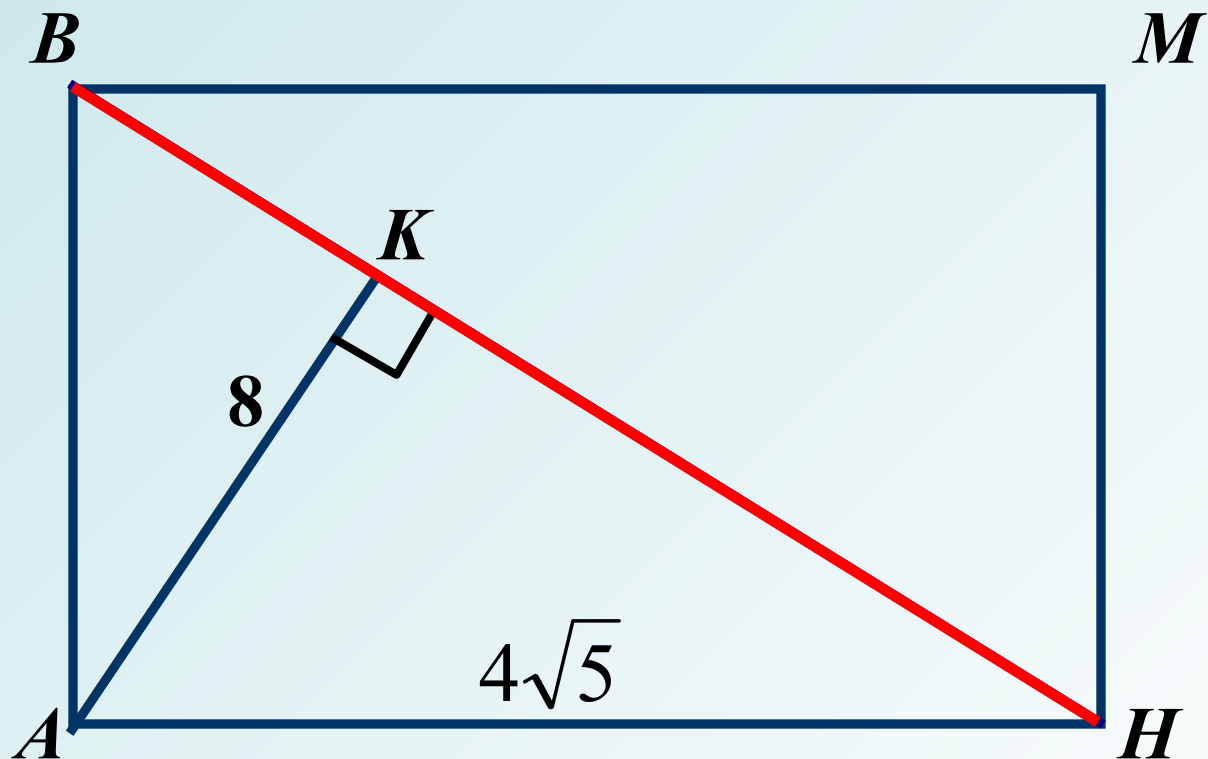

21.

Дано:

$AC \perp BD$ – о́дàíàõöèÿ

Найти:

S_{ABCD}

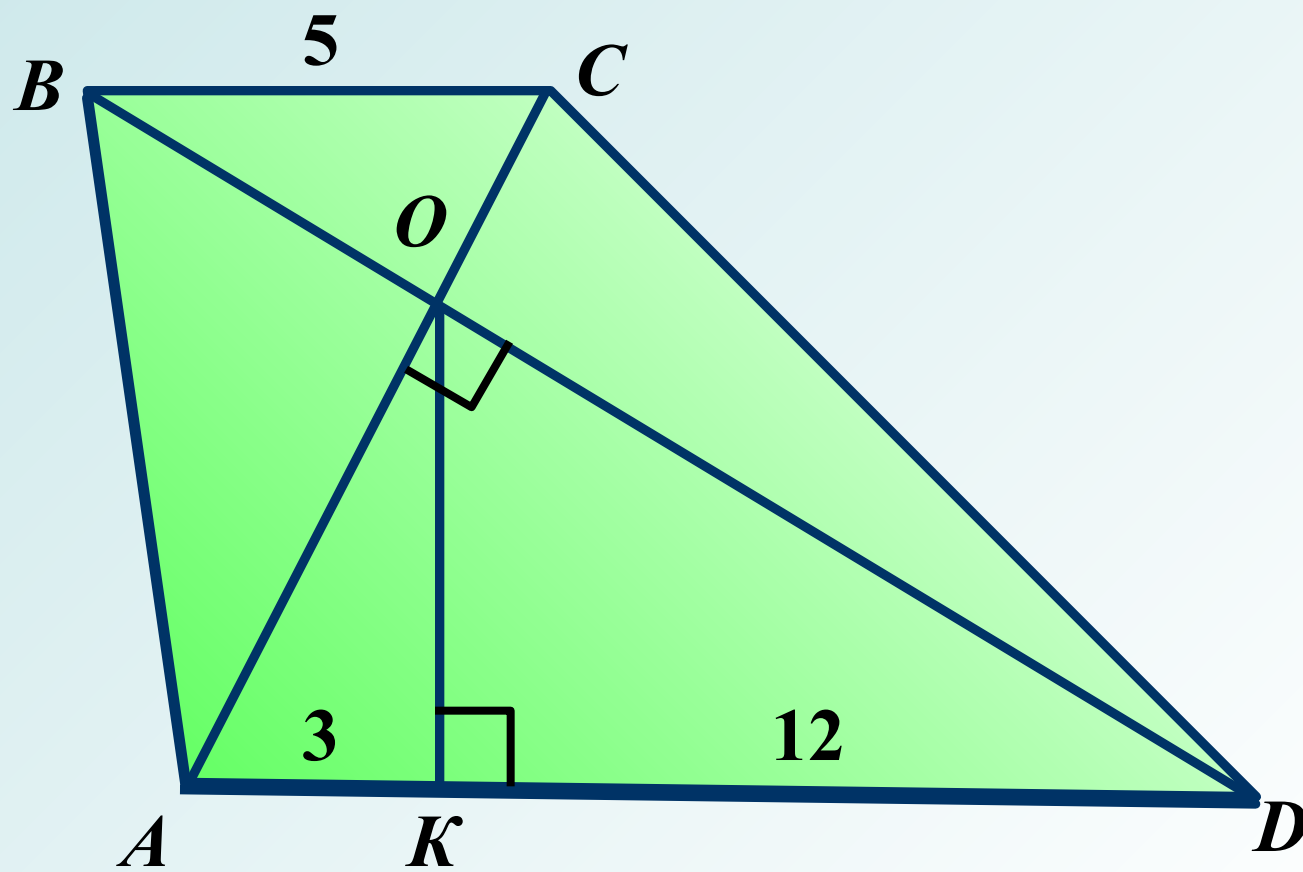

22.

Дано:

$\triangle MND$ – осн. равнобедр.

$$MN = 10 \text{ см}$$

Найти:

CF

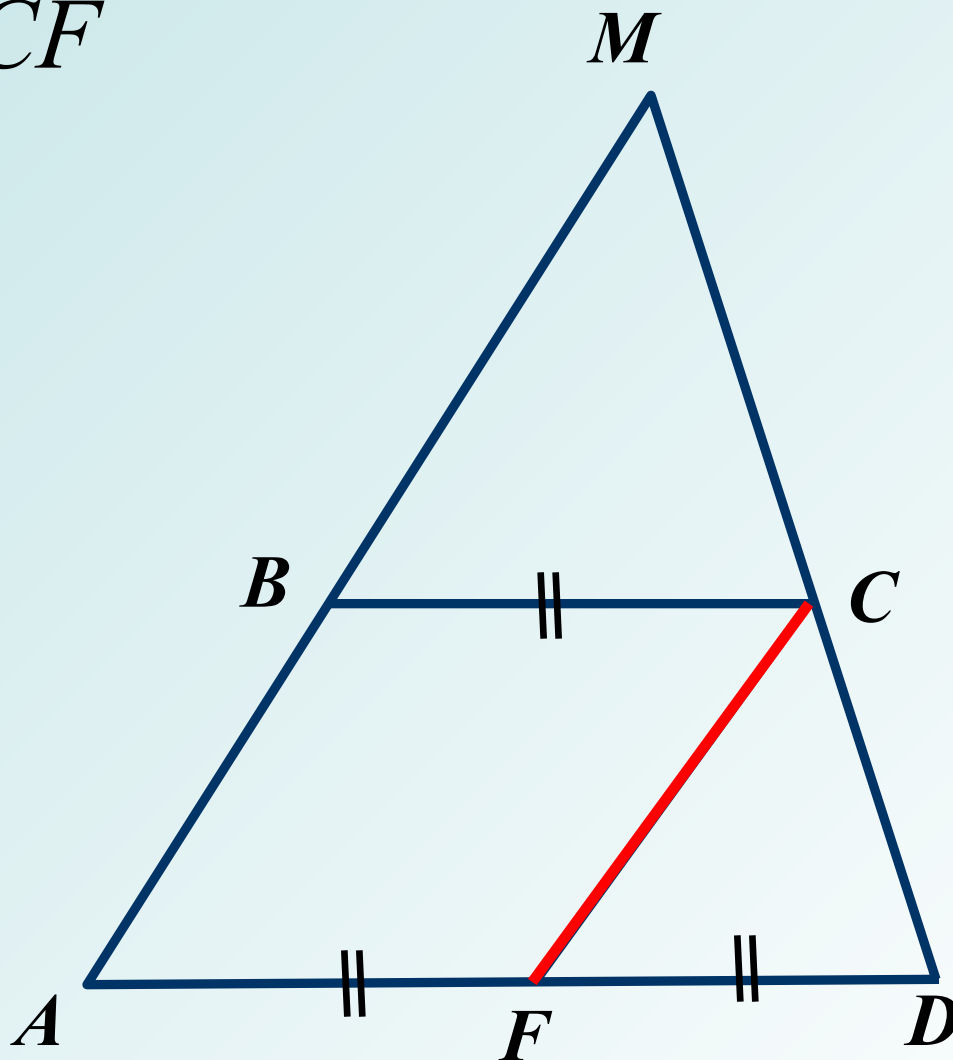

23.

Дано:

$\tilde{N}A\hat{I}A\hat{E}I\hat{I}A\hat{F}$

$$CA + AF + AE = 21$$

Найти:

$\tilde{N}A$, $A\hat{E}$, $A\hat{F}$

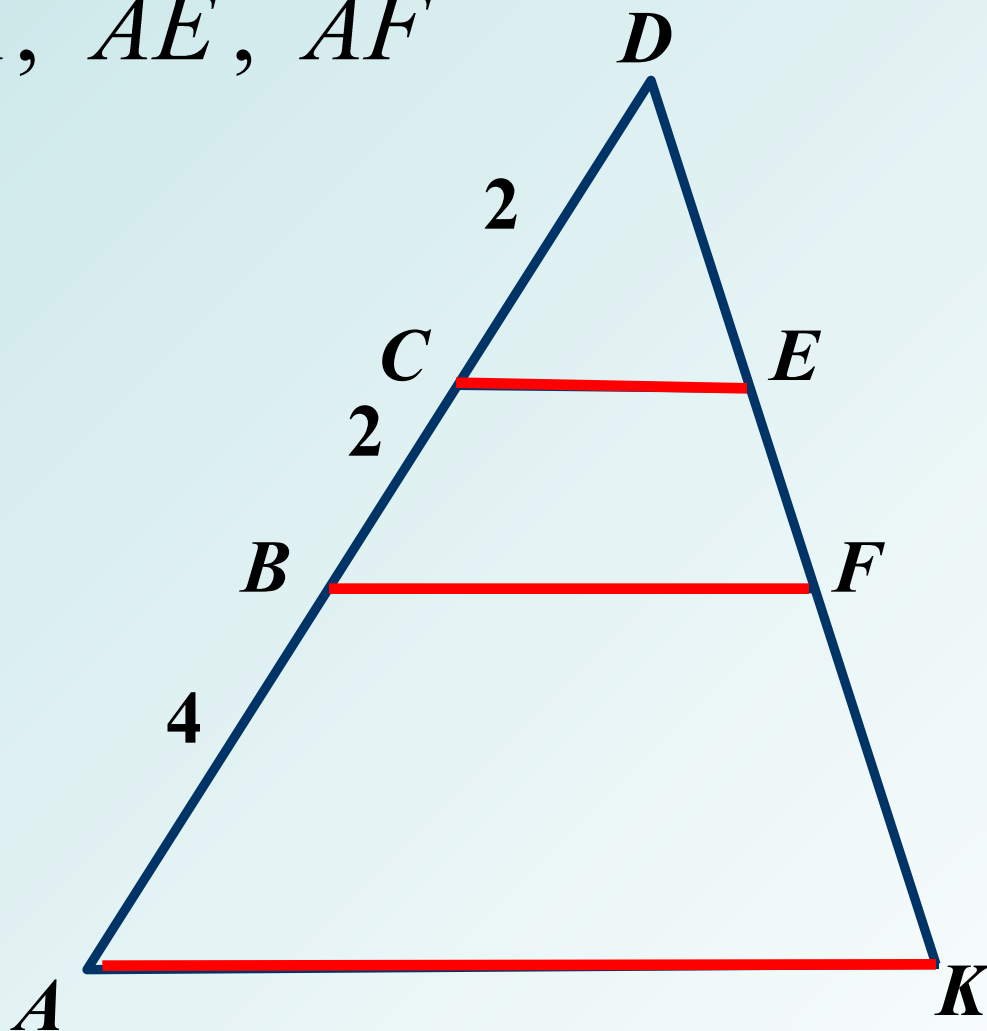

24.

Дано:

$$\hat{E}\hat{I}_1 = \hat{I}_1\hat{D}, \quad \hat{A}\hat{A}\hat{M}\hat{I}\hat{D}$$
$$\hat{A}B = 18$$

Найти:

$\hat{I}\hat{D}$

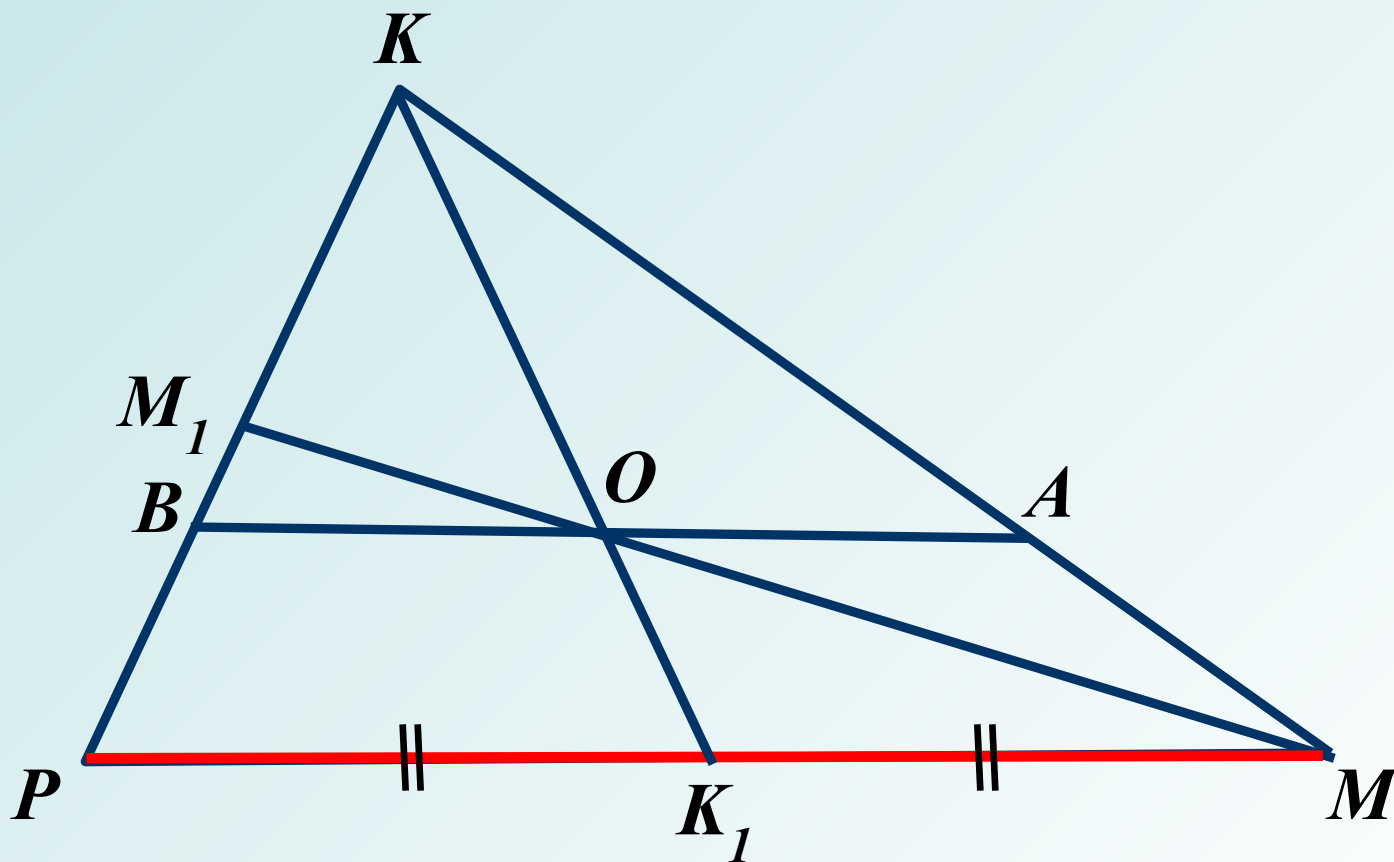

25.

Дано: $\triangle ABC$

Найти: \hat{A}

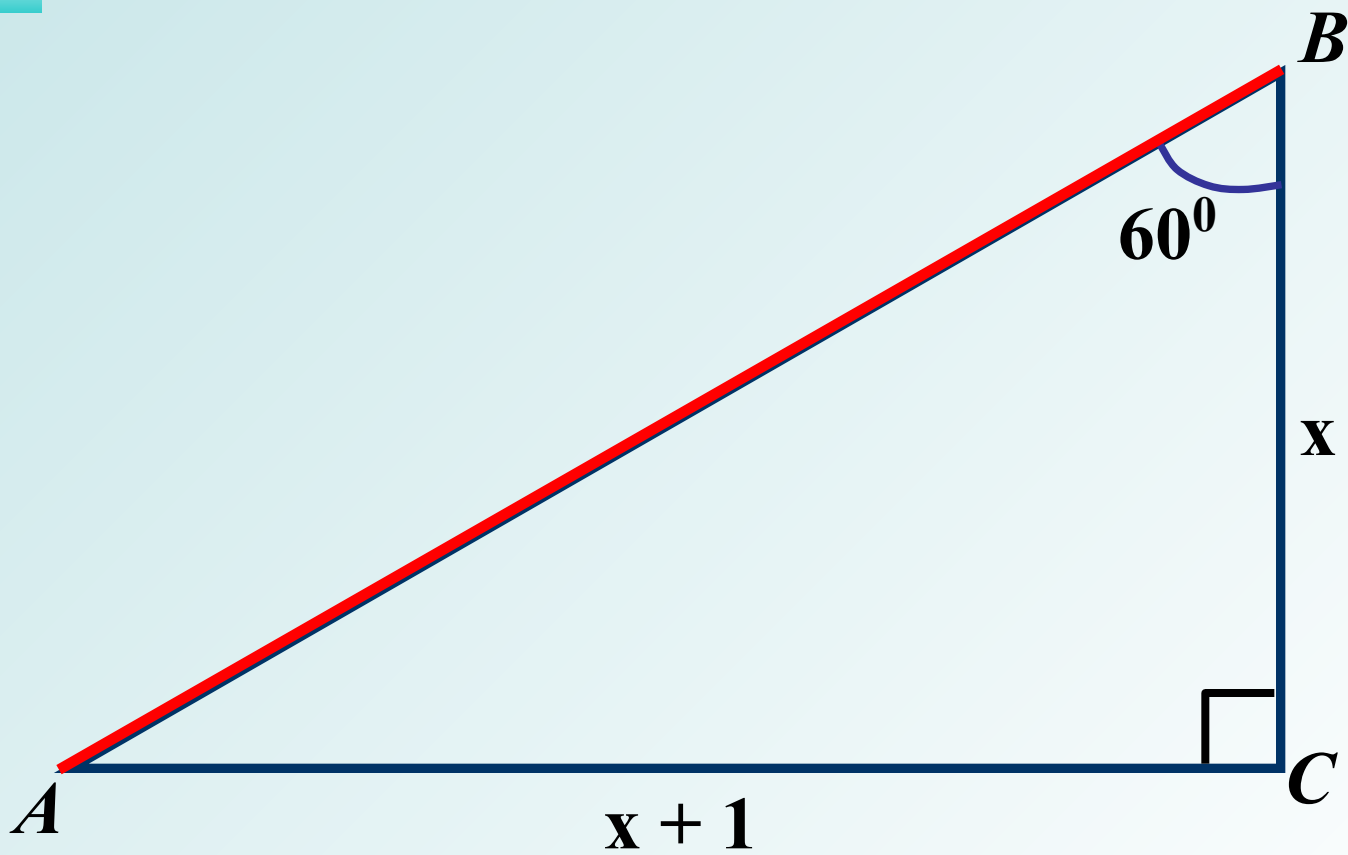

27.

Дано:

$ABCD$ – трапеция

Найти:

AB , BC , S_{ABCD}

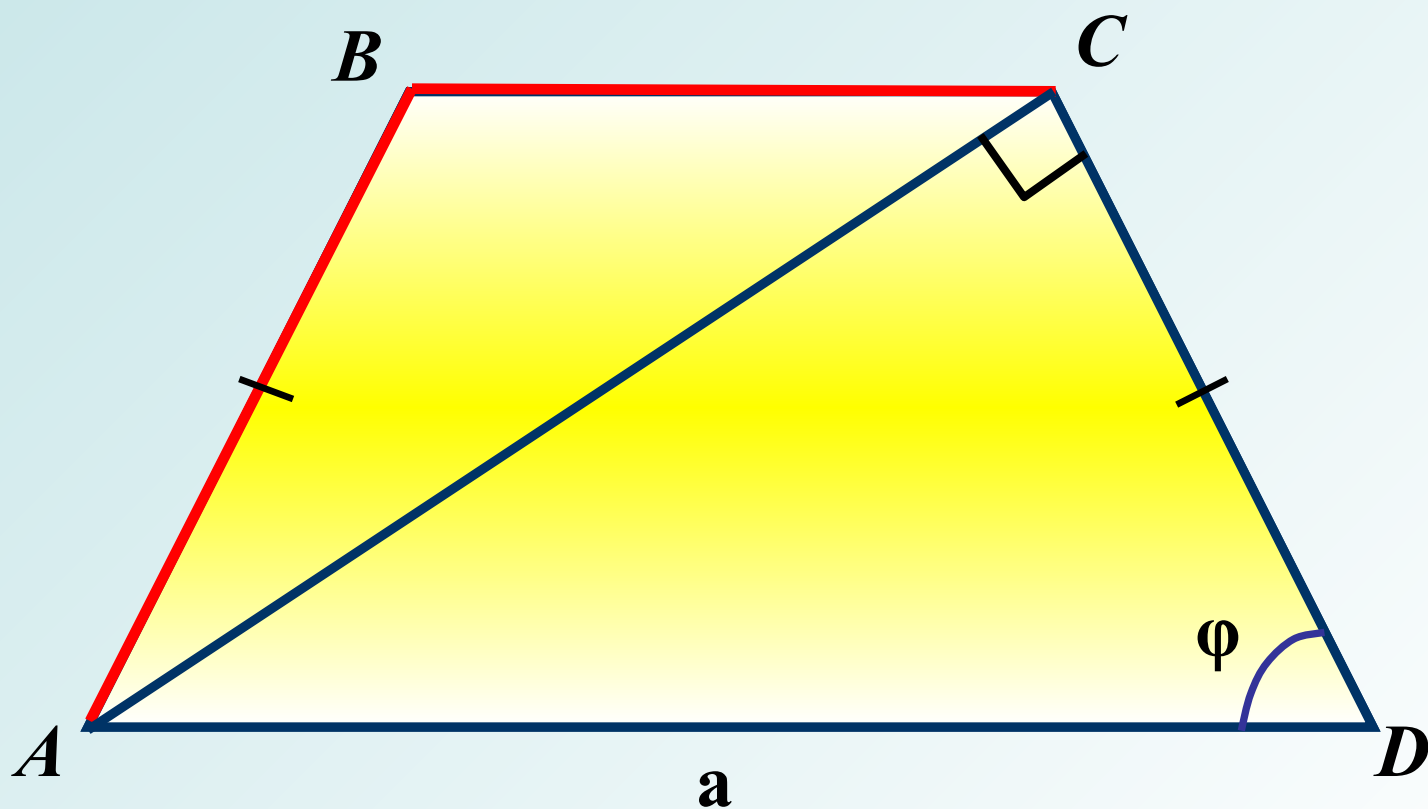

28.

Дано: $ABCD$ – о́дàïáöèÿ

Найти:

P_{ABCD}

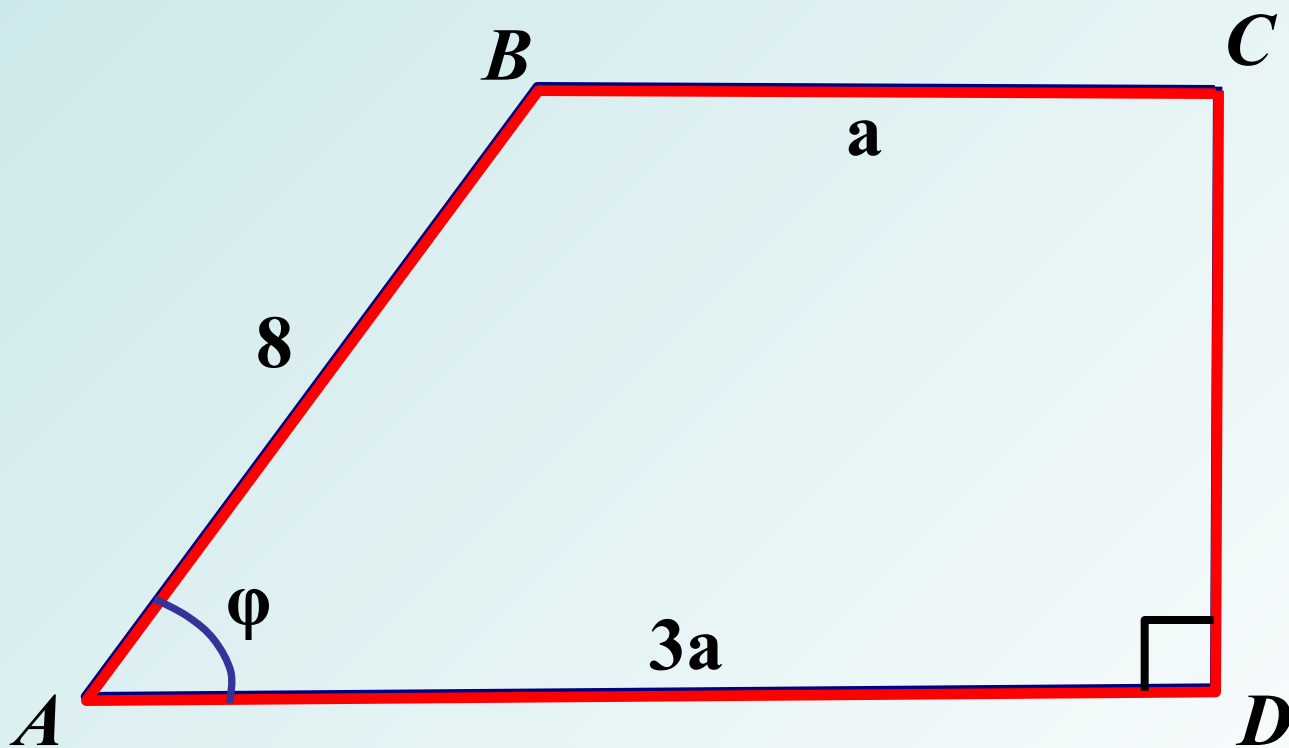

29.

Дано:

$ABCD$ – трапеция

$$\angle BAC = \beta$$

Найти:

AD

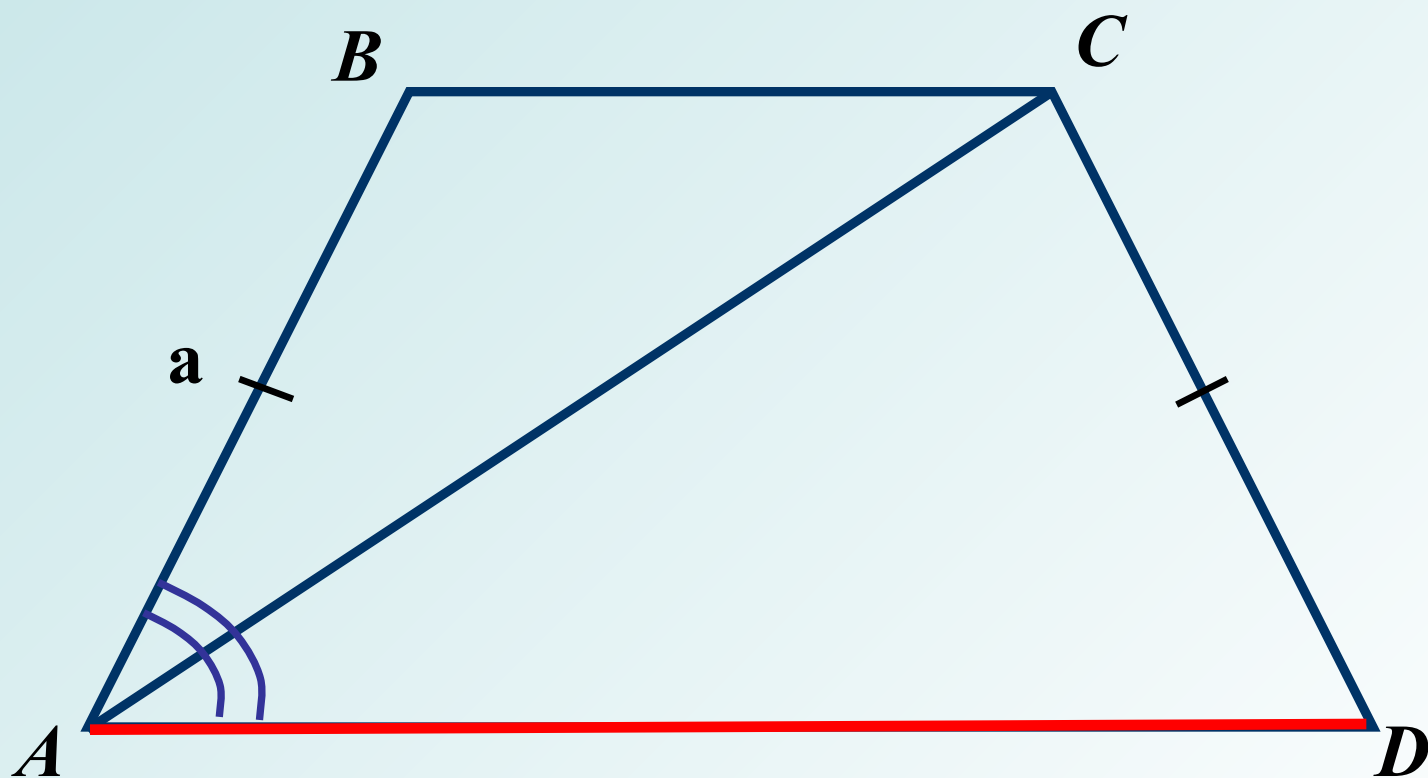

30.

Дано: $\angle BOB_1$

Найти: AB , A_1B_1

