

Проблема возникающая при
использовании лекарственных
препаратов (преодоление
резистентности, структура и
функции MDR-насоса)

STRUCTURE OF GLYCOPROTEIN P.

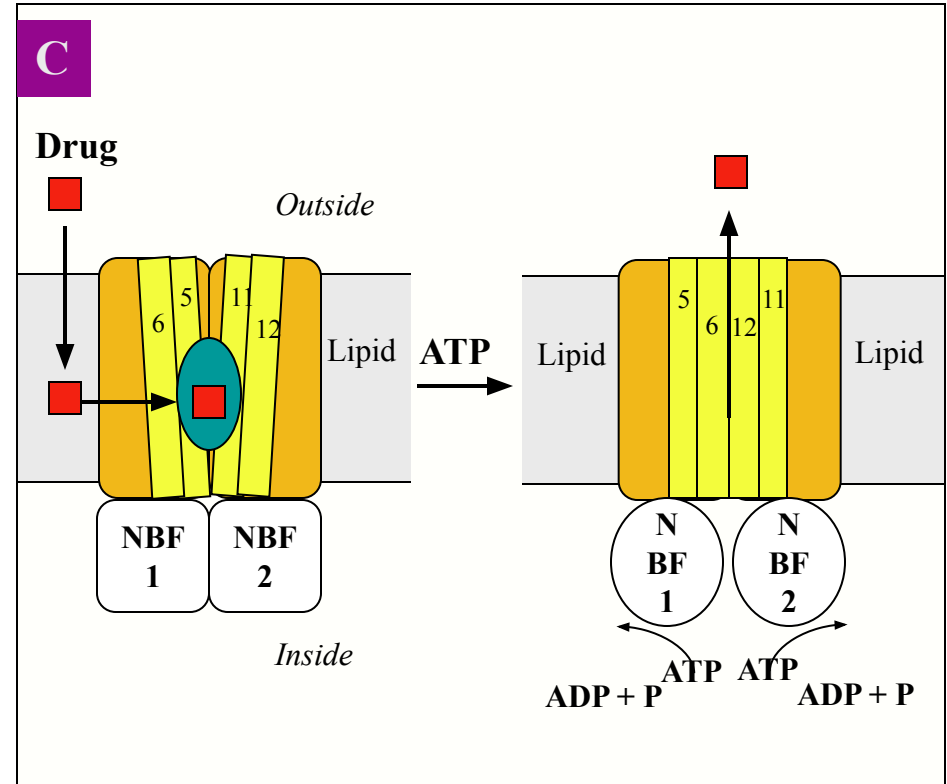

MULTIPLE DRUG RESISTANCE OF TUMOR CELLS

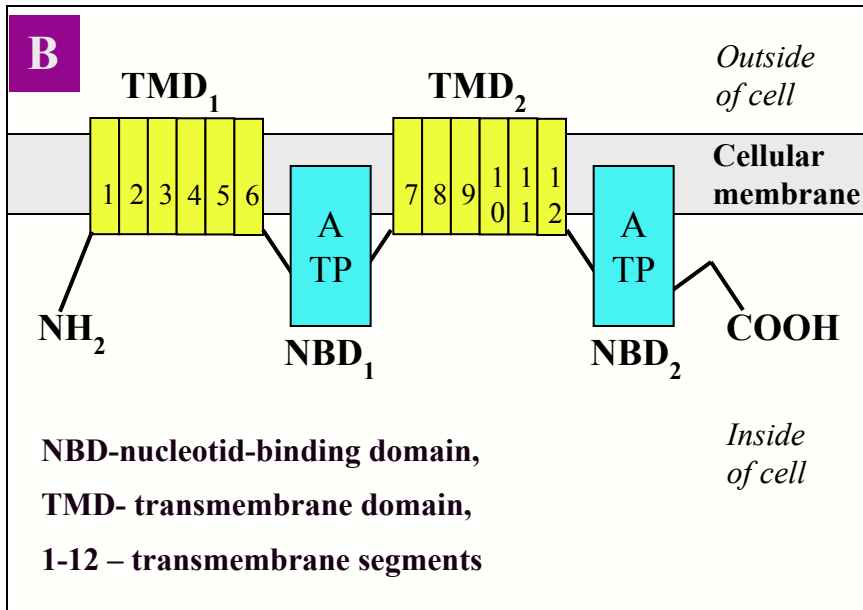
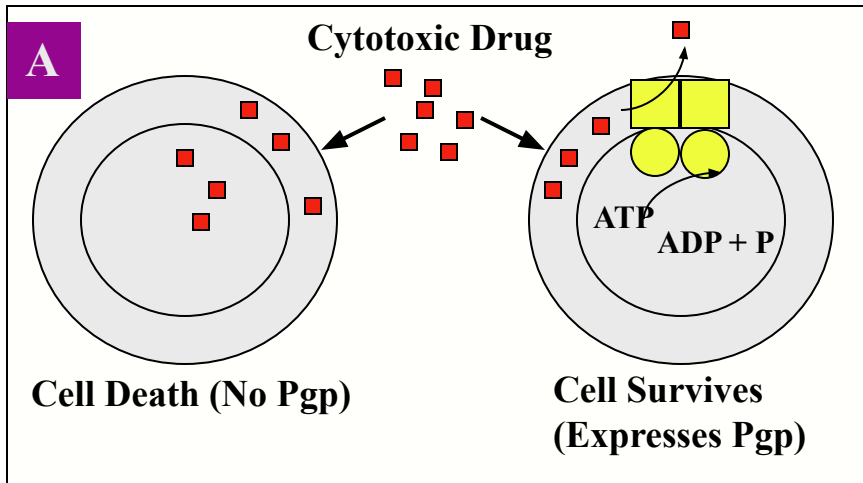
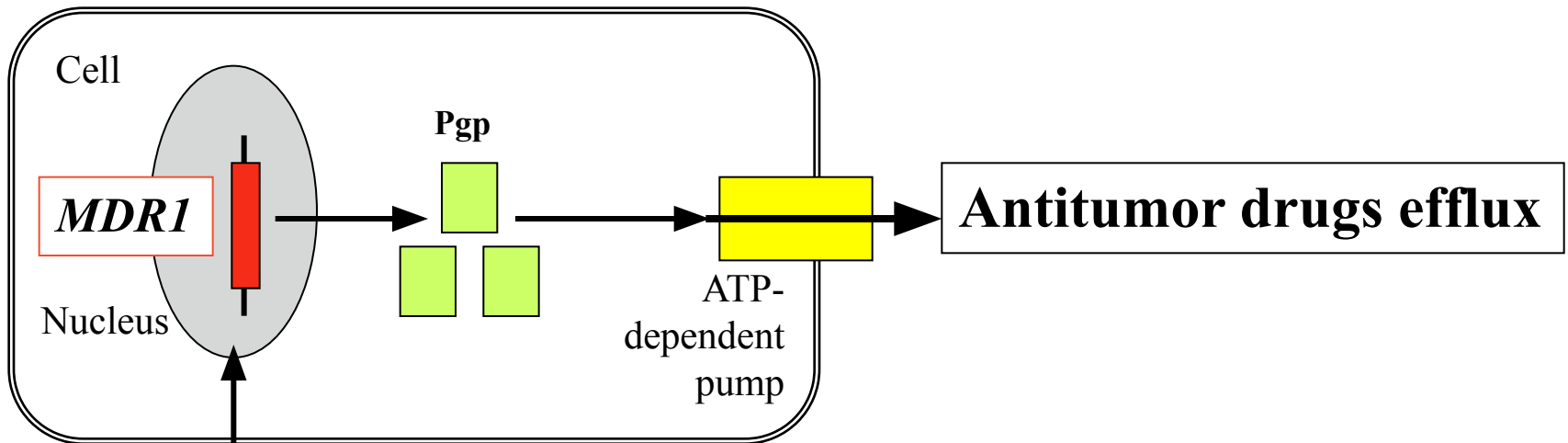

MDR1 activation

Antitumor substances:

- HSP
- Xenobiotics
- Cytostatics
- Steroid drugs
- Toxic substances
- Hypoxia,

UV-radiation

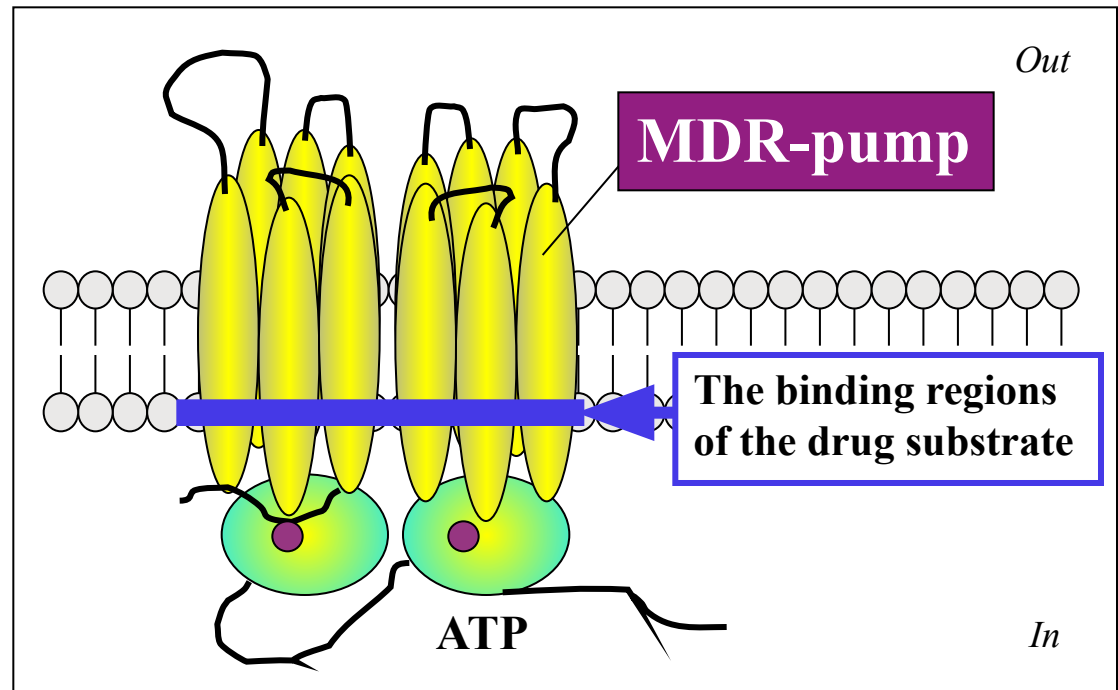

STRUCTURE of MDR-PUMP

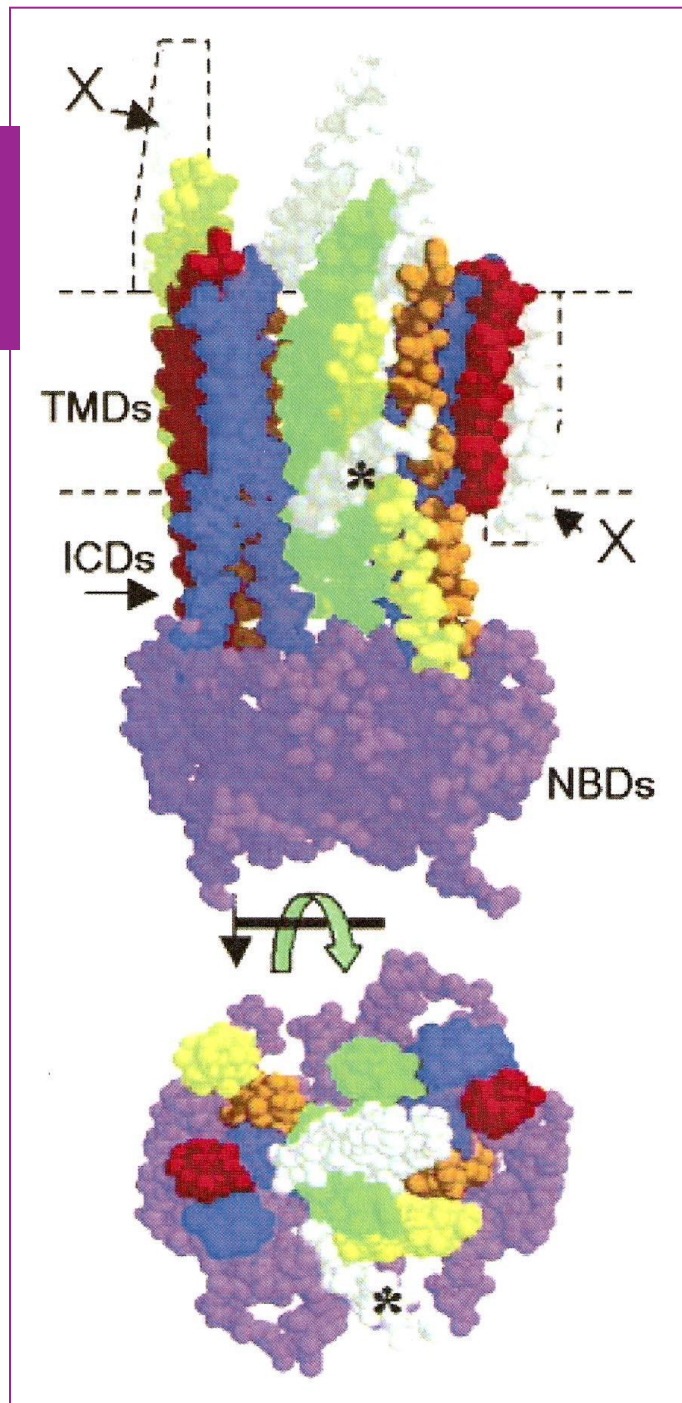

TRANSPORT OF SUBSTRATES VIA THE MDR-PUMP

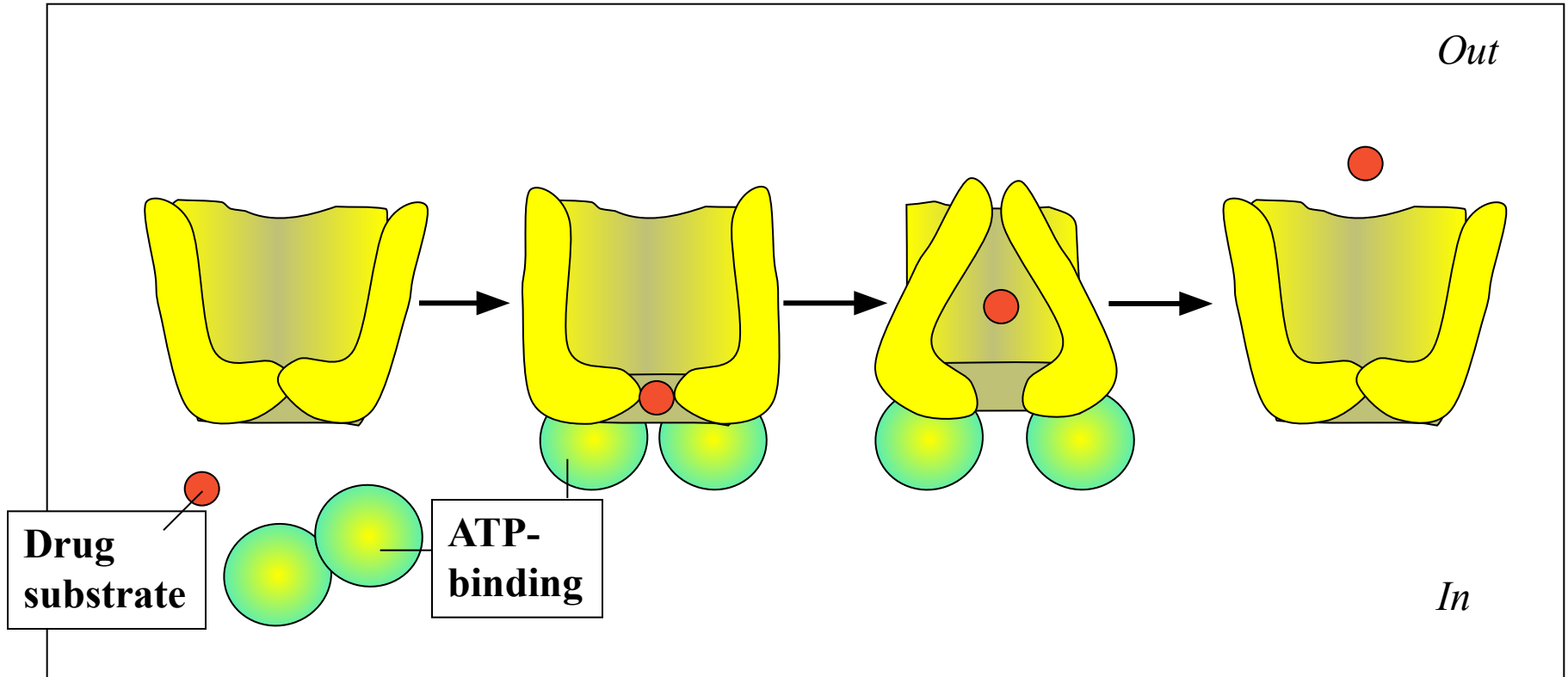

Chris van der Does and Robert Tampe
How do ABC transporters drive transport?
2004, *Biol. Chem.*, Vol. 385, pp. 927–933

FUNCTION OF THE MDR-PUMP

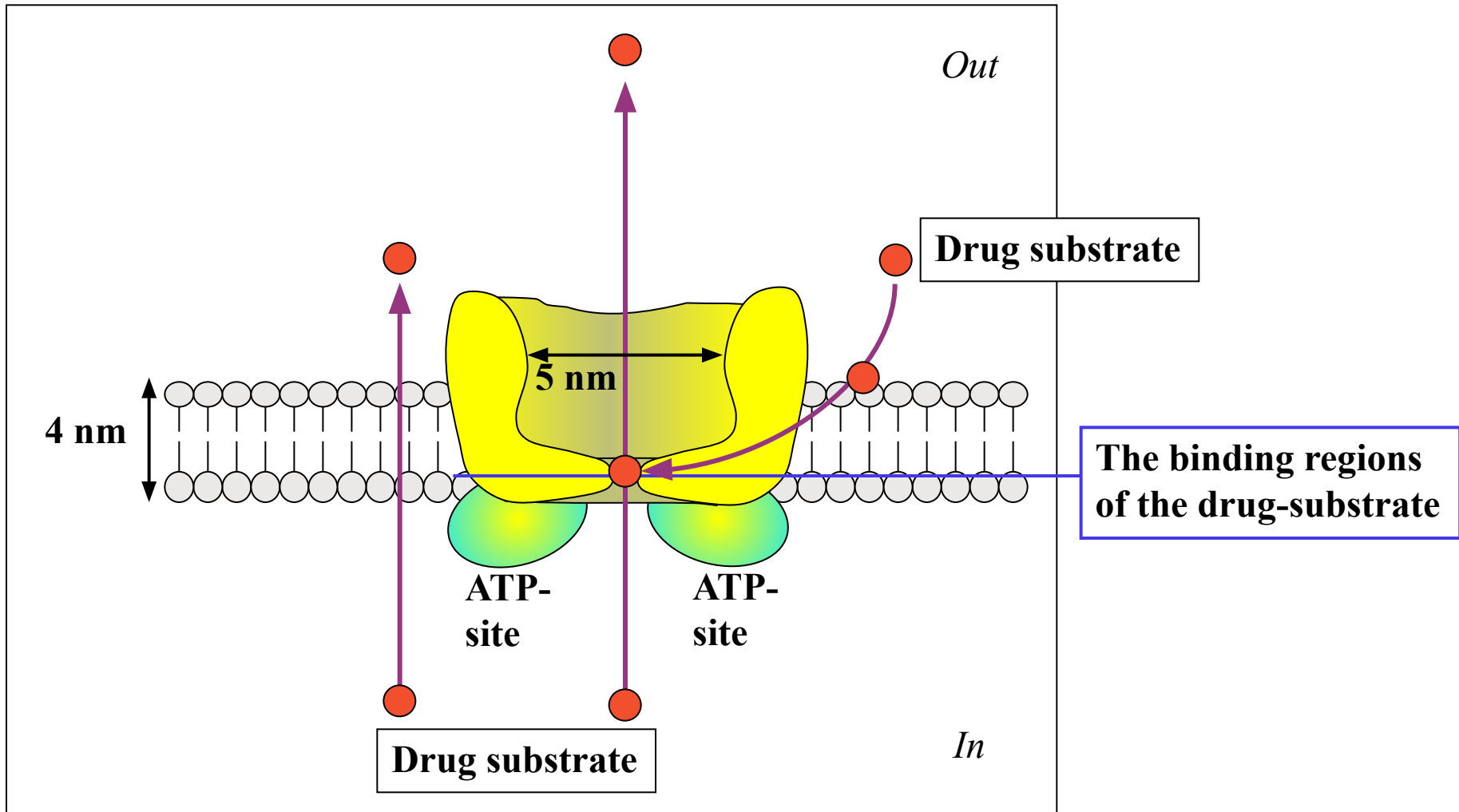

ATP-DEPENDENT CYTOSTATIC DRUGS TRANSPORT MECHANISM

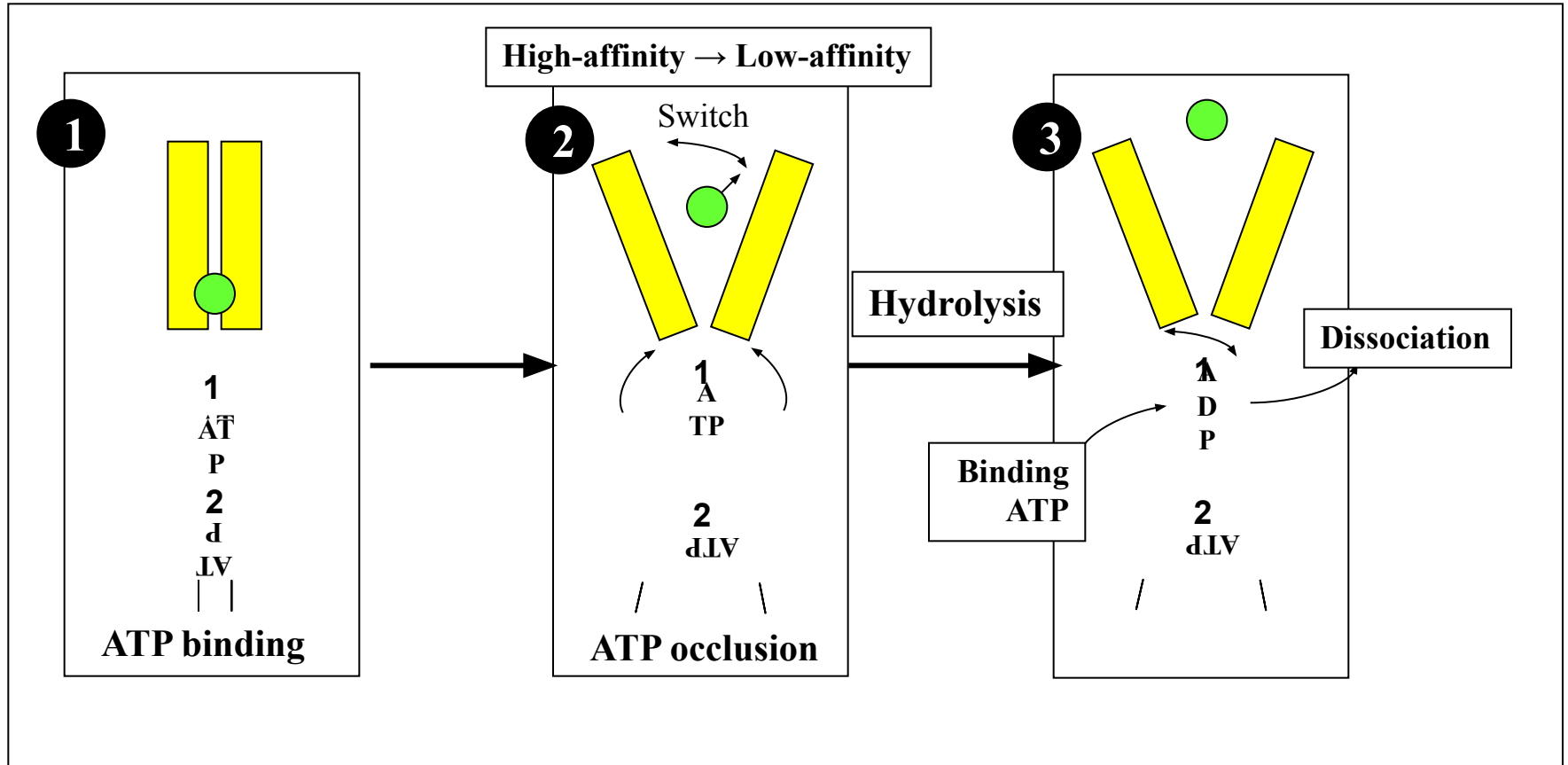

Zuben E. Sauna and Suresh V. Ambudkar
About a switch: how P-glycoprotein (ABCB1) harnesses the energy of ATP binding and hydrolysis to do mechanical work
 2007, *Mol Cancer Ther*, №6(1), pp.13-23

TRANSCRIPTION OF *MDR1*

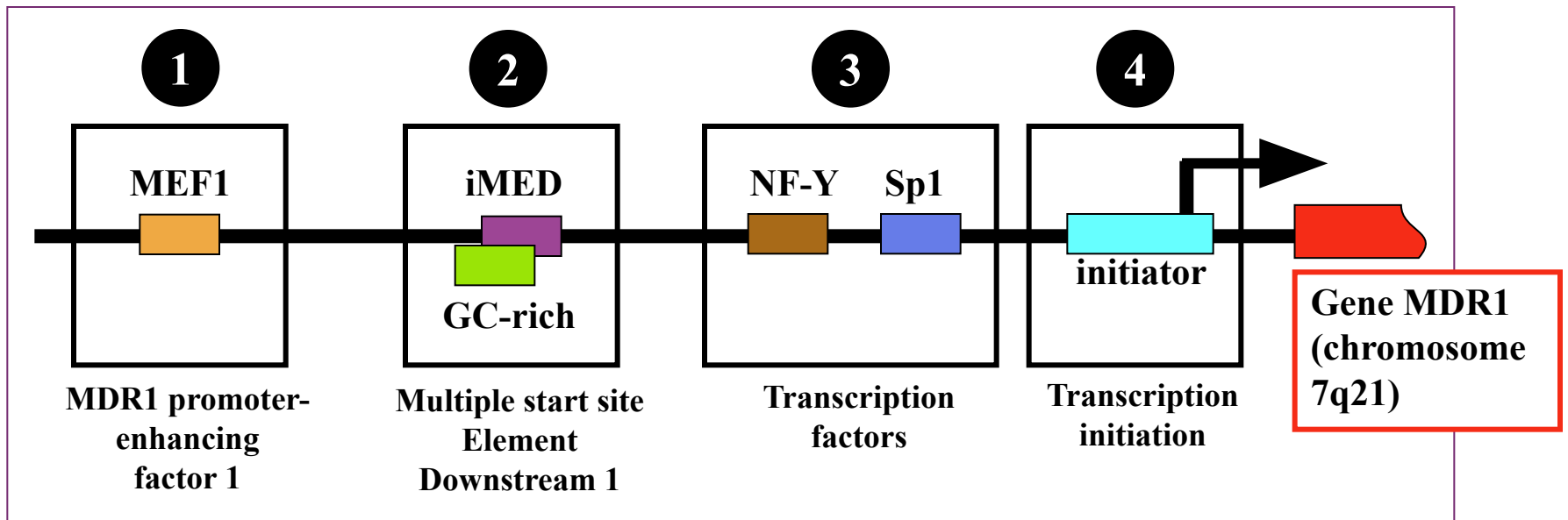

Proteins involved in *MDR1* transcription

Kathleen W. Scotto and Robert A. Johnson
Transcription of MDR1
Molecular Interventions, 2001, vol.1, pp.117-125

МЕХАНИЗМ УСТОЙЧИВОСТИ ОПУХОЛЕВЫХ КЛЕТОК К ДЕЙСТВИЮ ПРОТИВОРАКОВЫХ ПРЕПАРАТОВ

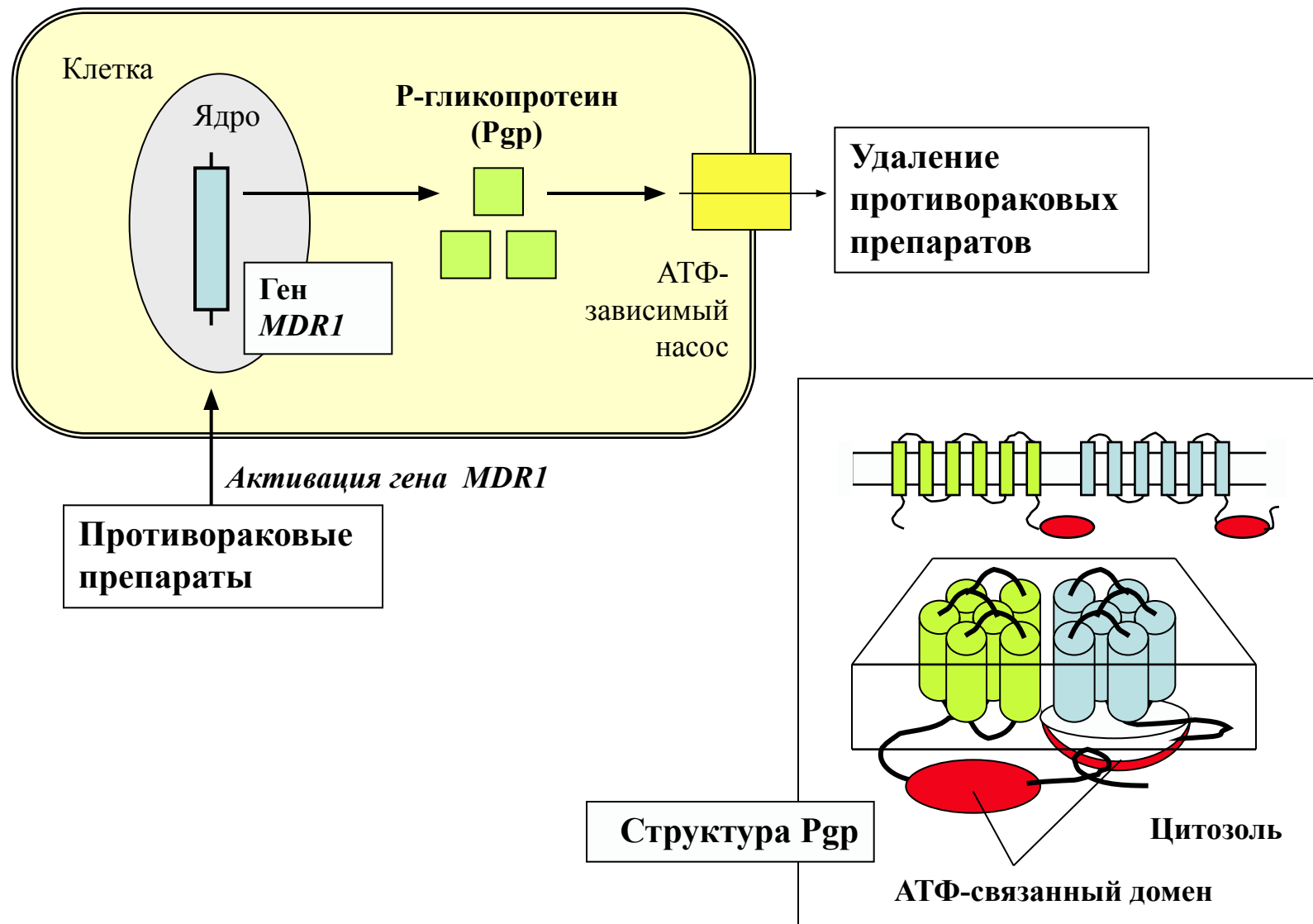

SELECTED ANTI-CANCER DRUGS THAT ARE SUBSTRATES FOR THE FACTORS RESPONSIBLE FOR MULTIDRUG RESISTANCE

Name	Substrates
Pgp	Doxorubicin, daunorubicin, epirubicin, etoposide, paclitaxel, docetaxel, vincristine, vinblastine, rhodamine-123, chloroquine, quinidine, aldosterone
MRP1	Vincristine, daunorubicin, doxorubicin, etoposide
MRP2	Methotrexate, etoposide, cisplatin, vinca alkaloids
MRP3	Etoposide, teniposide, estrogen derivatives, methotrexate, vinca alkaloids
MRP4	Purine analogues, estrogen derivates
MRP5	Thiopurines, cyclic nucleotides
GSTs	Chloroethylnitrosoureas, cisplatin, anthracyclines, phosphamides
Topo II	Chloroethylnitrosoureas, epipodophyllotoxins, cisplatin, anthracyclines

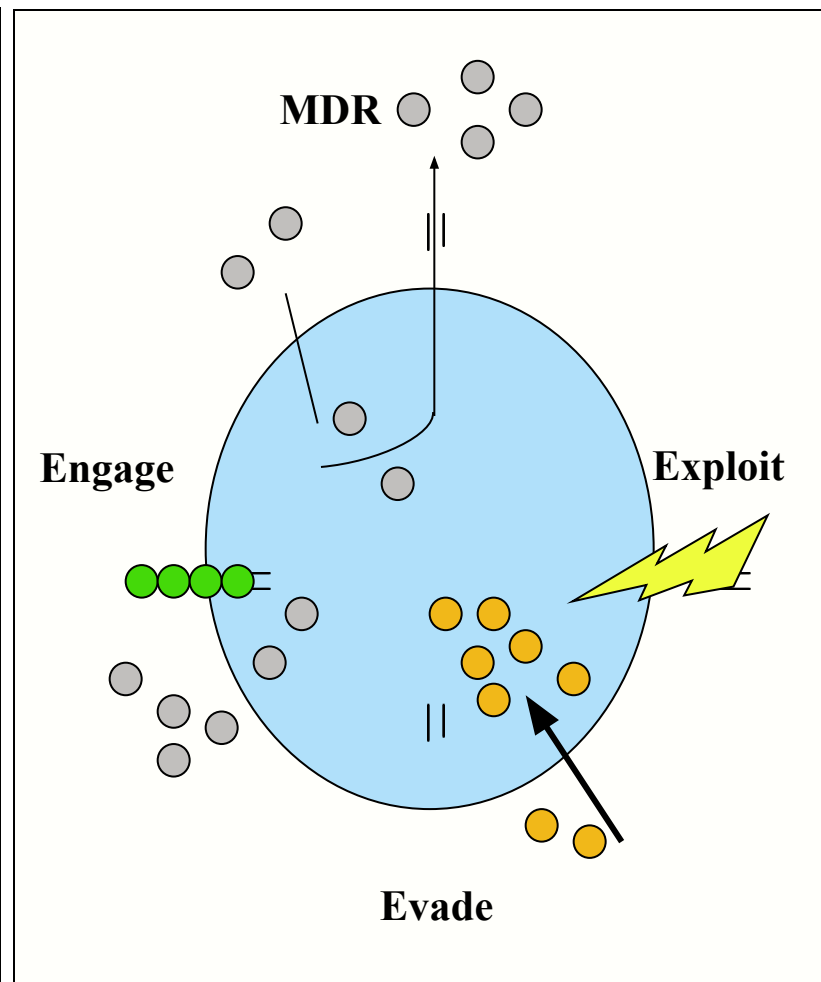

ACTIVITY OF MDR-PUMP

A

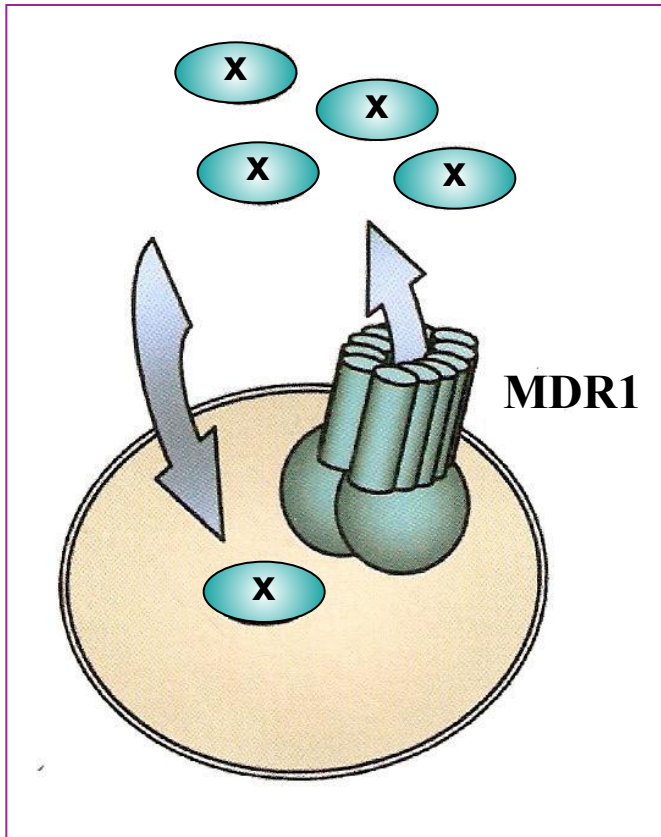

B

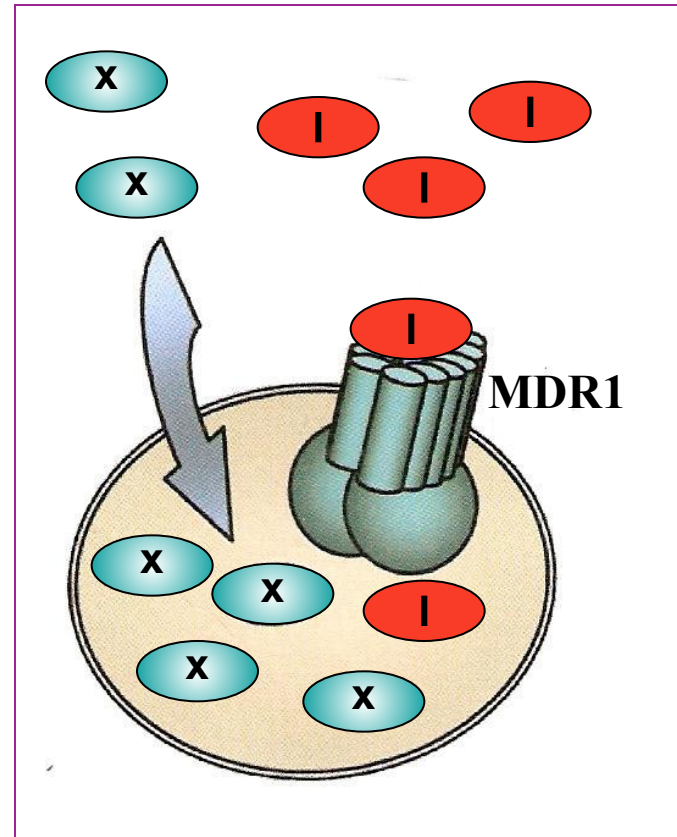

TWO TYPES OF DRUG CELLULAR MIGRATION EVENTS IN OVERCOMING MDR :

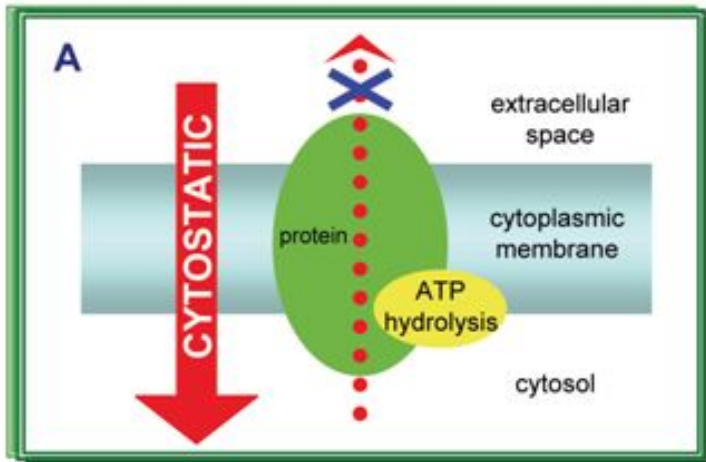

A. Influx of cytosstatic without mediated efflux

Транспорт цитостатика через мембрану.
Отсутствует средство к MDR-насосу

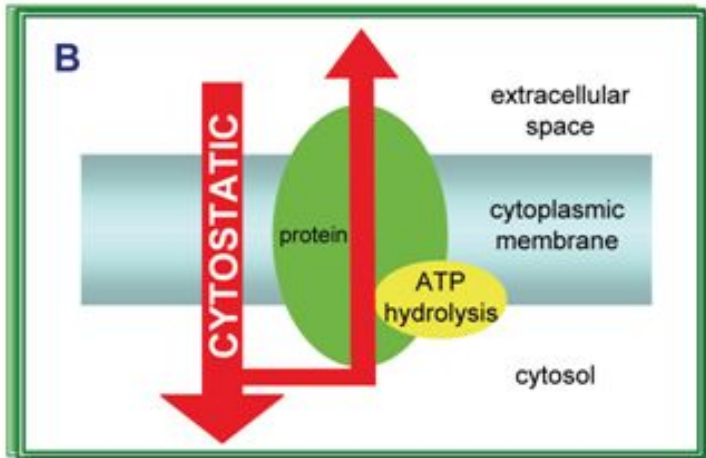

B. Influx surpassing mediated efflux

Транспорт цитостатика через мембрану
сопровождается выходом вещества через
MDR-насос

E.Borowski, M. Bontemps-Gracz, A.Piwkowska
**Strategies for overcoming ABC-transporters-mediated
multidrug resistance (MDR) of tumor cells,**
2005, *Acta Biochimica Polonica*, vol.52, №3,609-627

THE CIRCUMVENT OF THE MDR

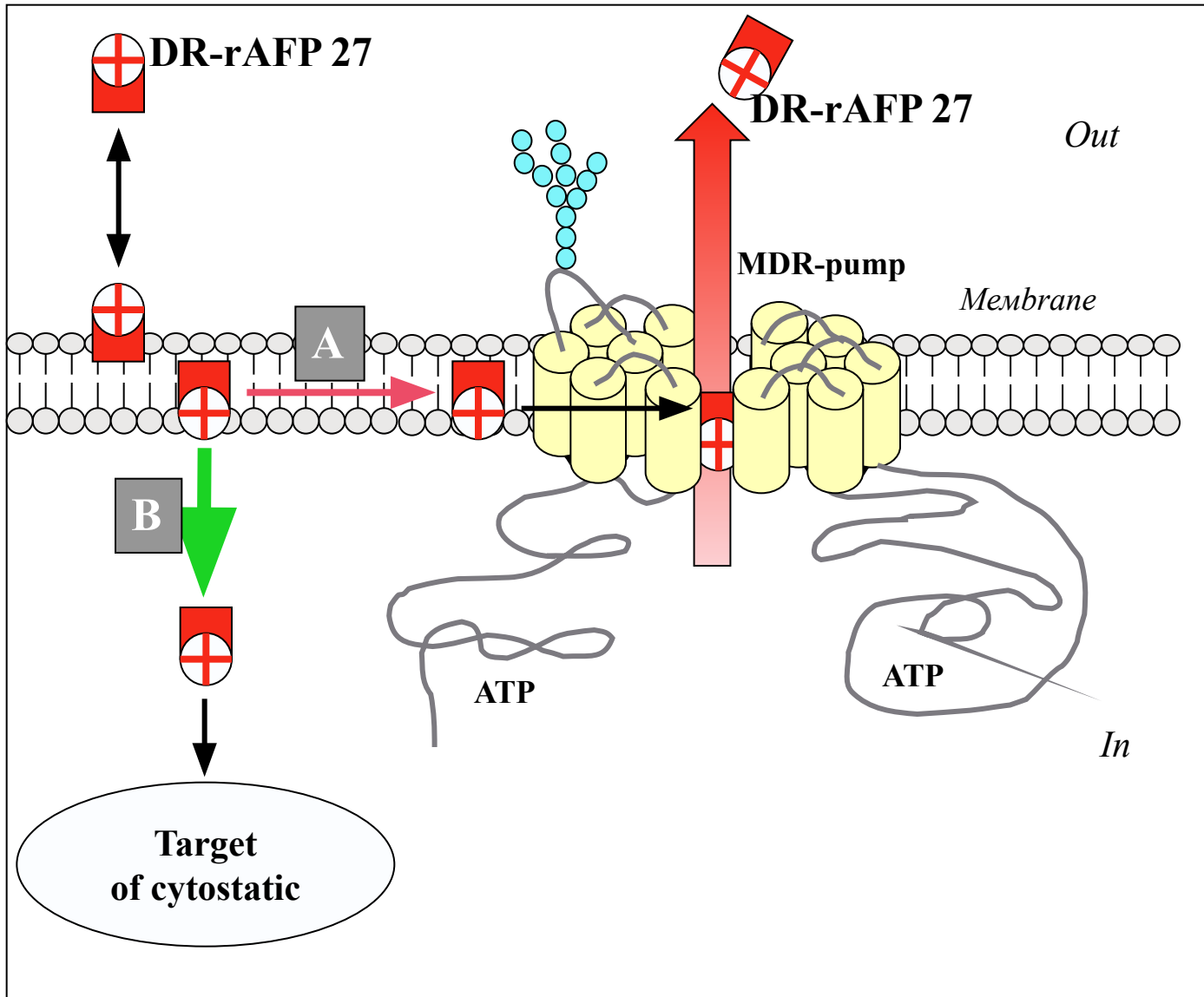

ПРЕОДОЛЕНИЕ МНОЖЕСТВЕННОЙ ЛЕКАРСТВЕННОЙ УСТОЙЧИВОСТИ И ПРОТИВООПУХОЛЕВАЯ АКТИВНОСТЬ КОНЬЮГАТОВ

Цитостатики:

- Эсперамицин
- Доксорубицин
- Винбластин
- Метотрексат
- Цис-платин

Антисенсы: (с-мус, bcl-2, tel)

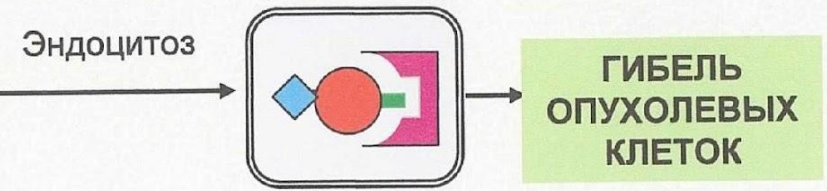
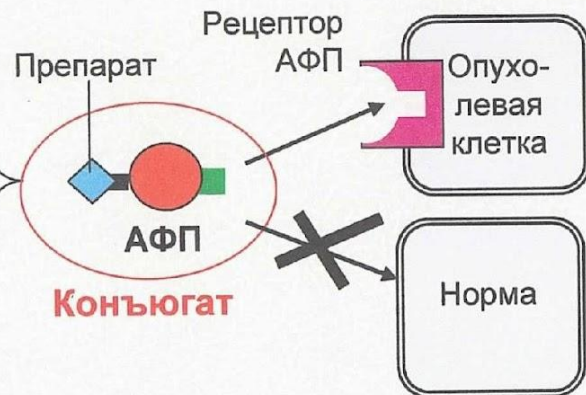

Действие конъюгата АФП-Доксорубицин на лекарственную устойчивость опухолевых клеток человека

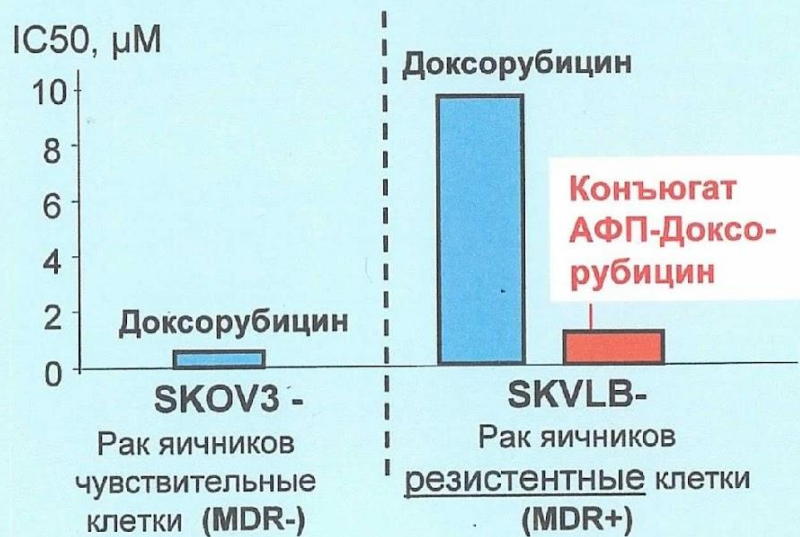

Механизм лекарственной устойчивости

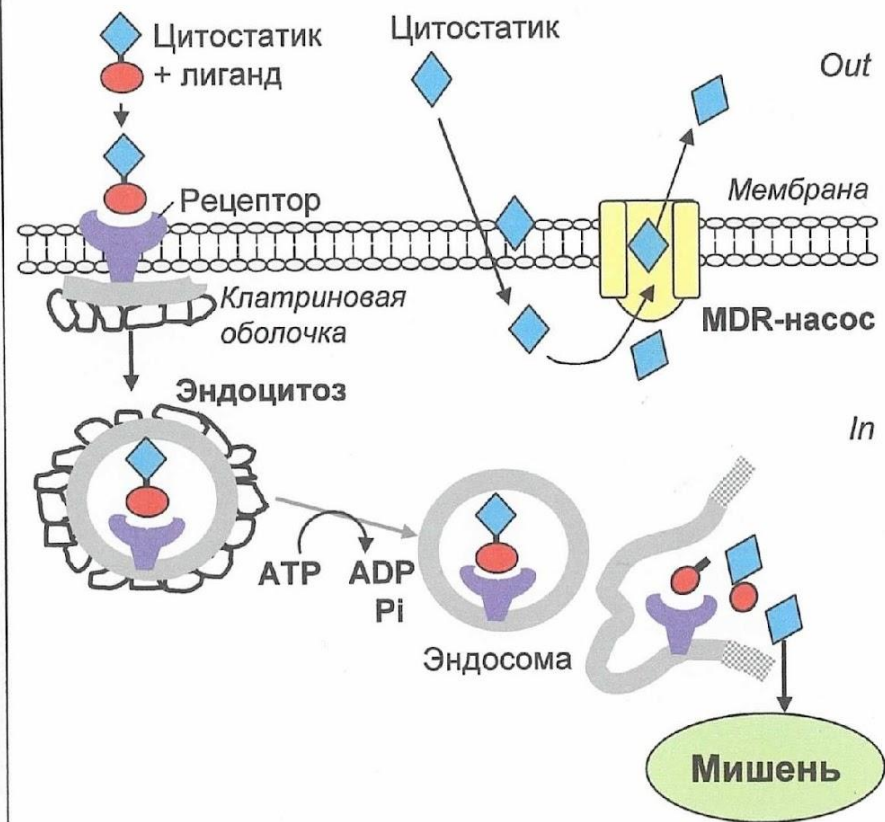

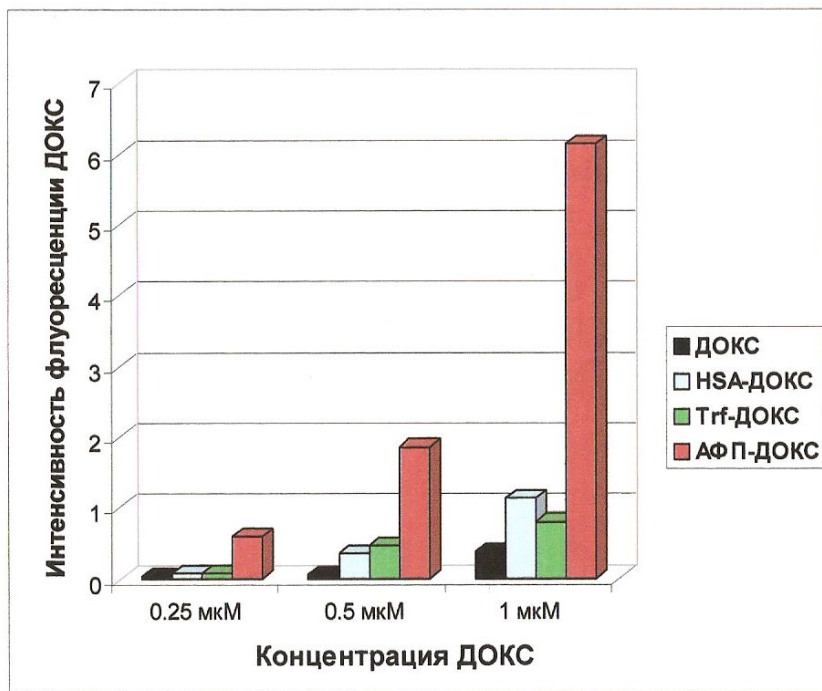
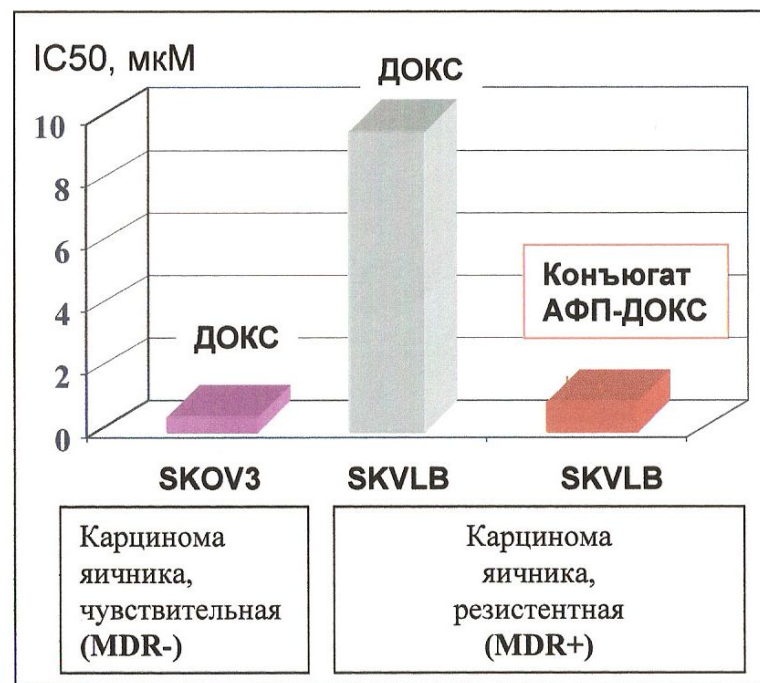
А**Б**

Изменение концентрации ломефлоксацина в печени с течением времени при однократном пероральном введении субстанции ЛВ и ЛВ, включенного в состав НЧ

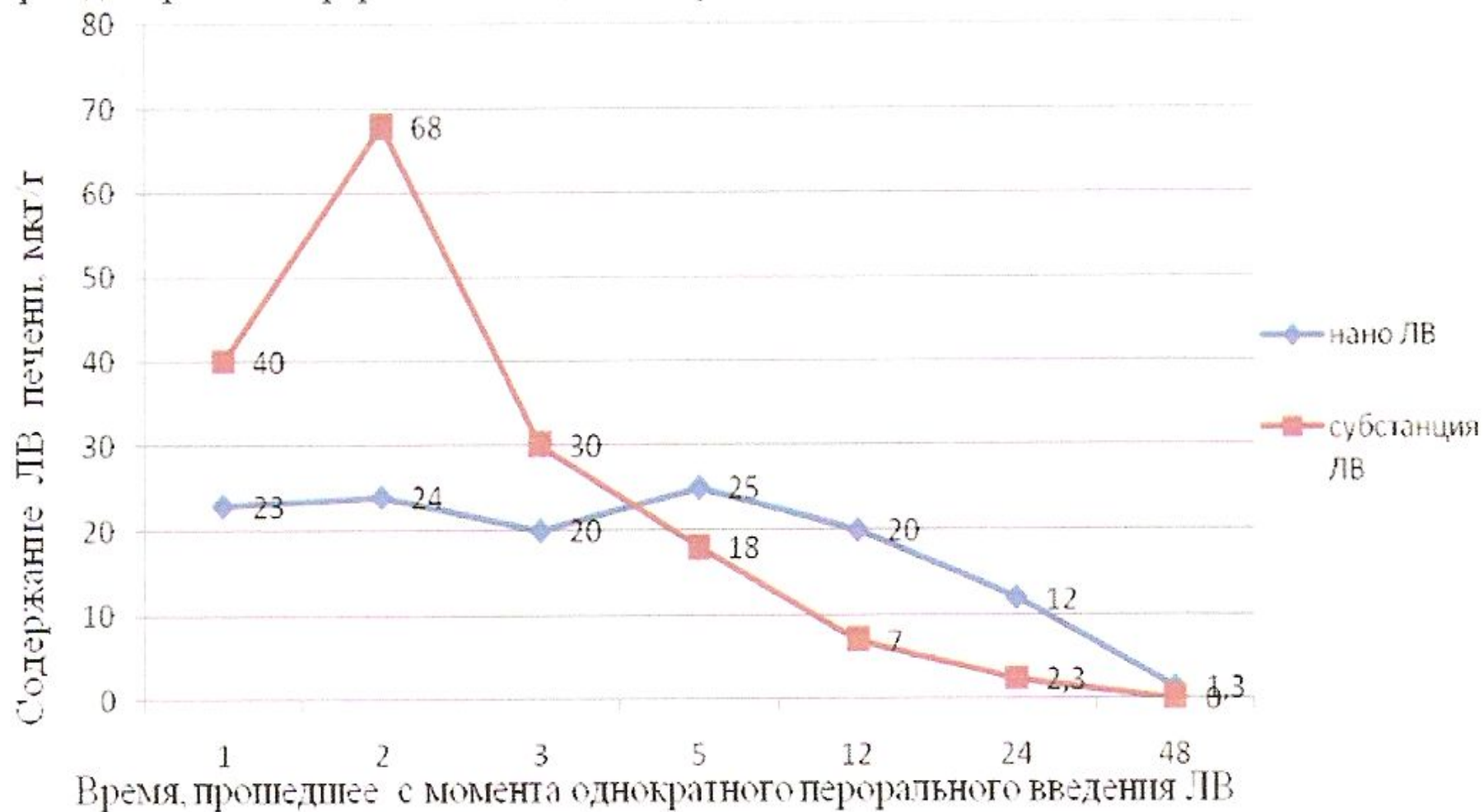

Biosynthesis of the uridine nucleotide precursors of the peptidoglycan. The points of inhibition by various substances are indicated.

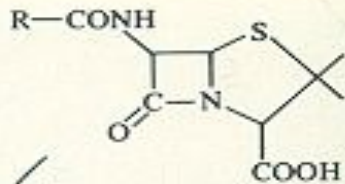
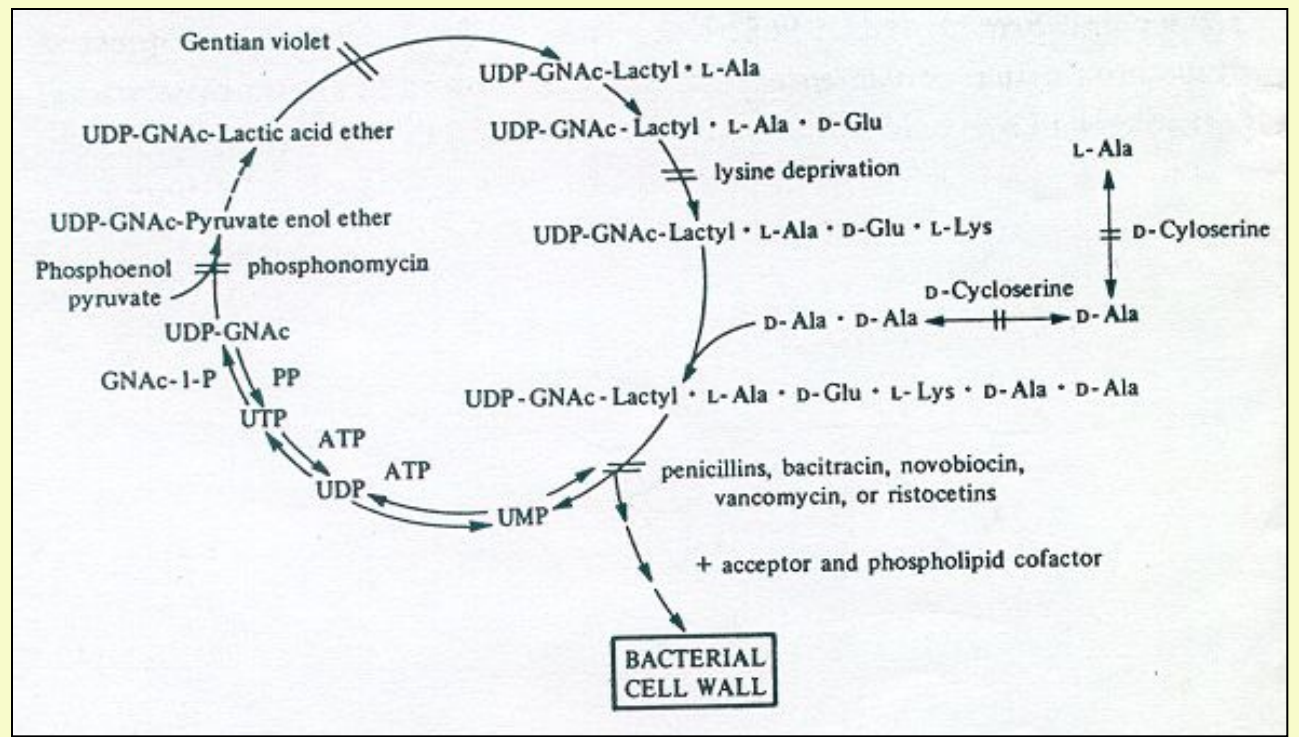

пенициллин

mechanism of inhibition of transpeptidation by penicillins

Пенициллин – циклический дипептид двух аминокислот: L-цистеина и D-валина (L-Cys-D-Val):

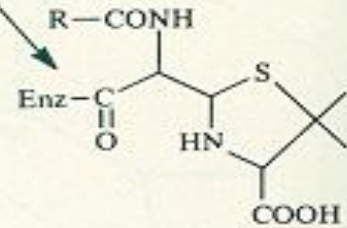

транспептидаза

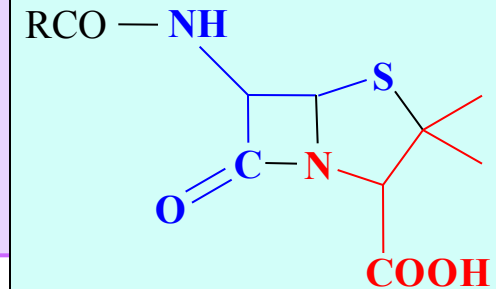

ОБРАЩЕНИЕ МНОЖЕСТВЕННОЙ ЛЕКАРСТВЕННОЙ УСТОЙЧИВОСТИ КОНЬЮГАТОМ АФП С ДОКСОРУБИЦИНОМ

Выявление белка MDR1 в опухолевых клетках (коричневое окрашивание)

Рак молочной железы человека

Рак яичника человека

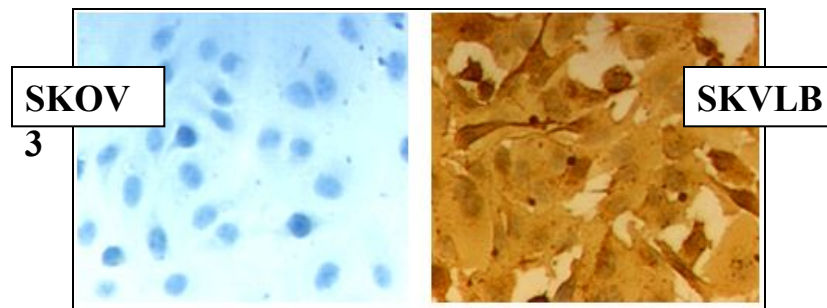
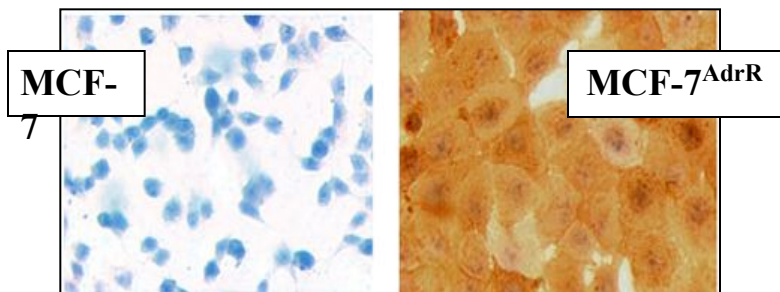

Резистентны к ДР

Резистентны к ДР

Резистентность MDR1⁺ клеток к доксорубину и высокая чувствительность к конъюгату АФП с доксорубицином

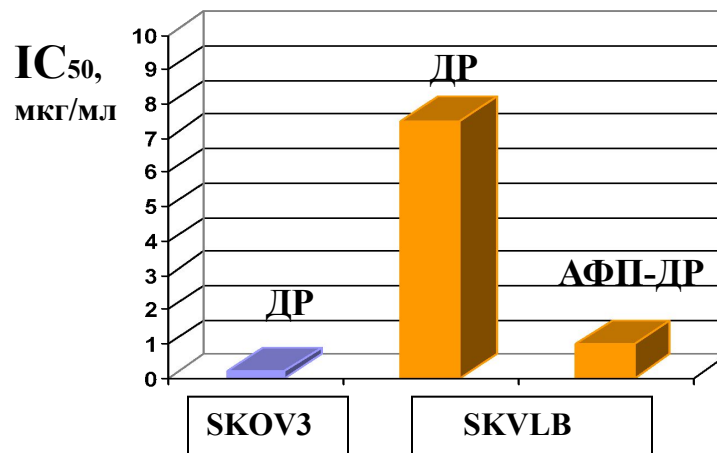
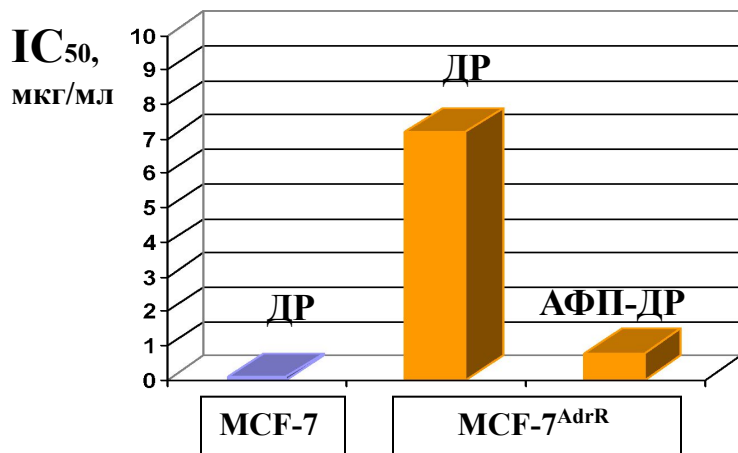

Десенситизация аденилатциклазы при воздействии адреналина, дибутирил-сАМР и протеинкиназы

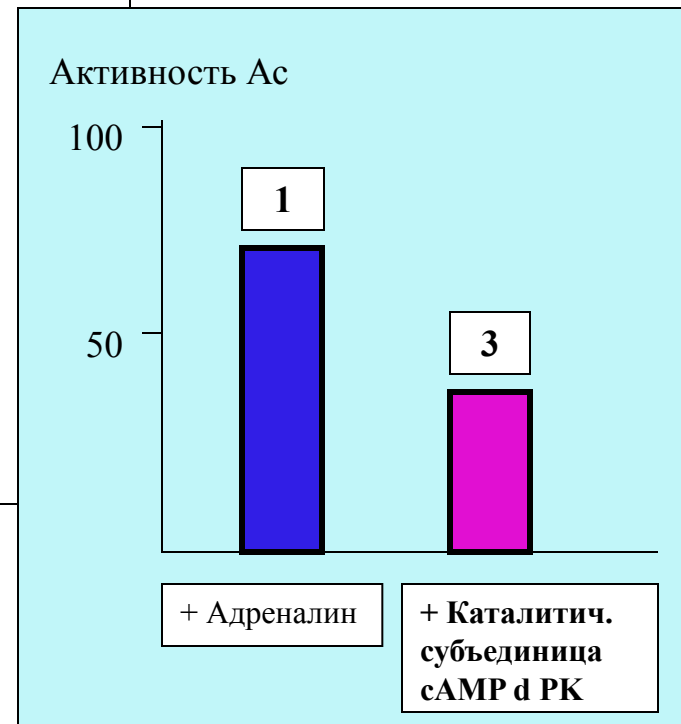
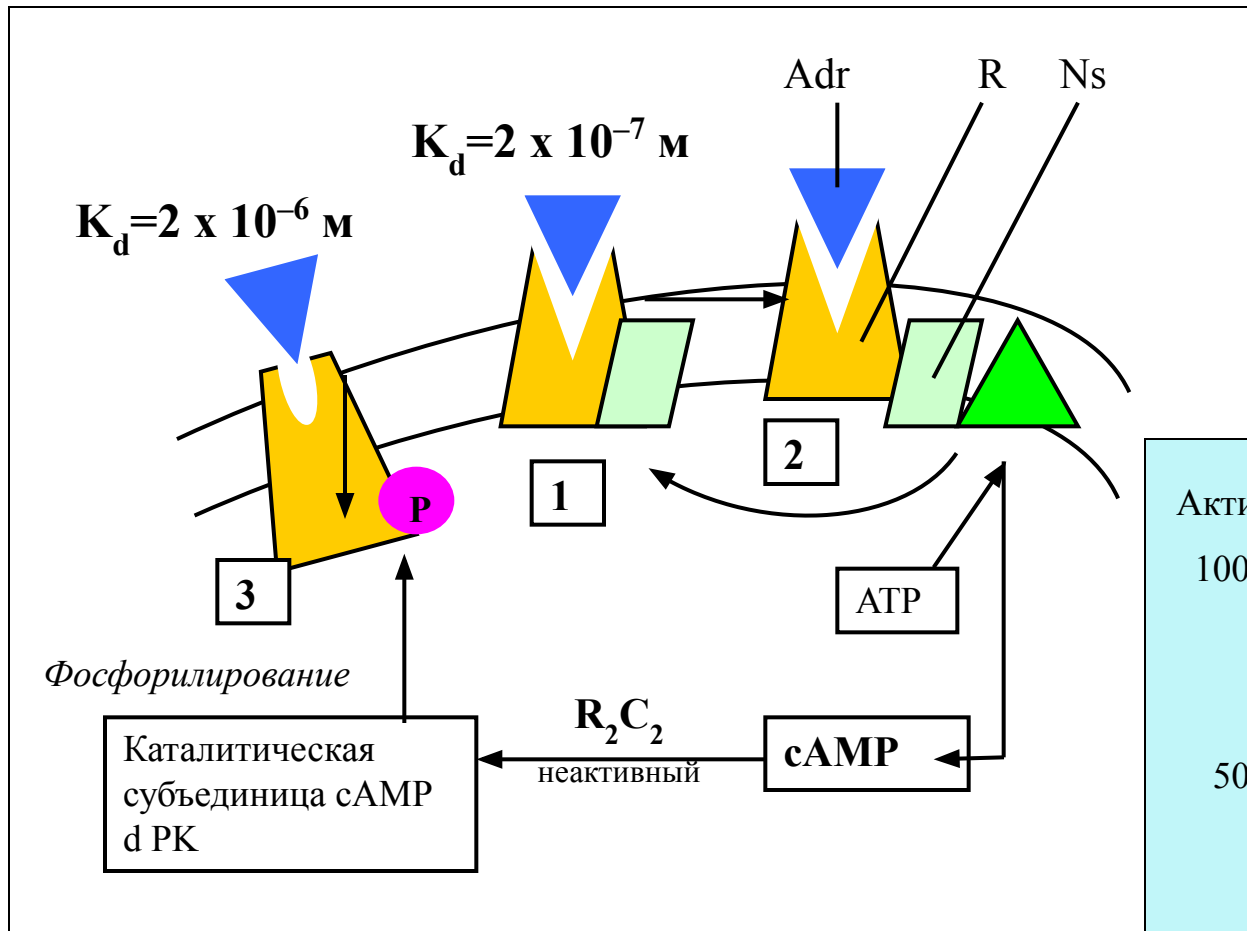

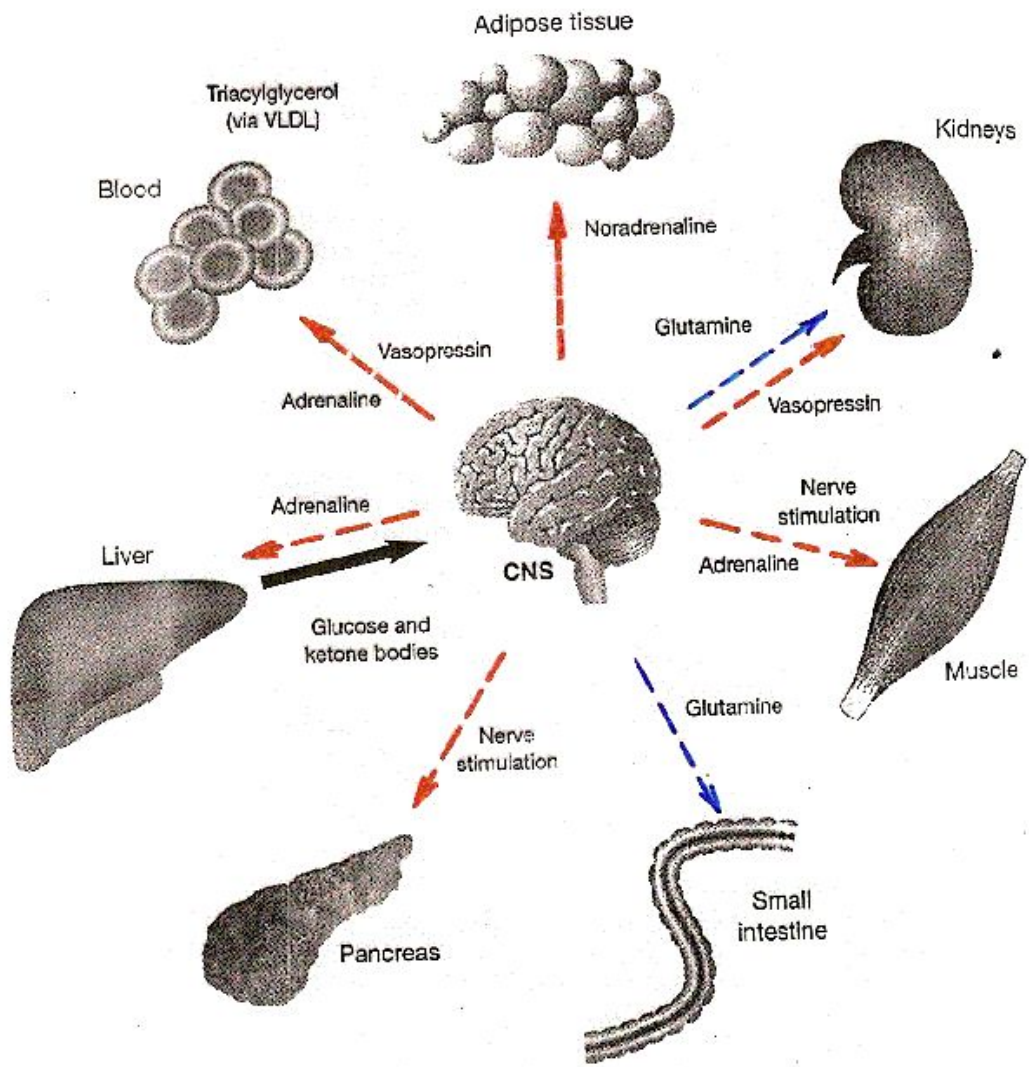
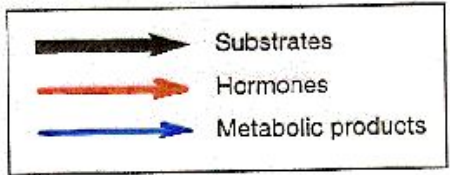

ADVANTAGES OF NANO DRUG DELIVERY FOR TREATMENT OF TUBERCULOSIS

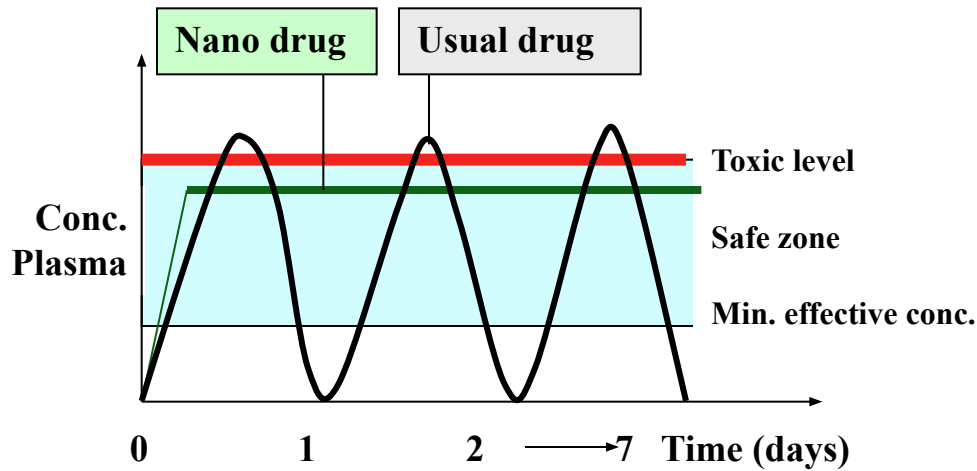

Reduce the dosage of antituberculosis drugs

- Reduce dosage frequency
- Minimise the toxicity of drugs
- Reduce the cost of TB treatment
- Improve patient compliance

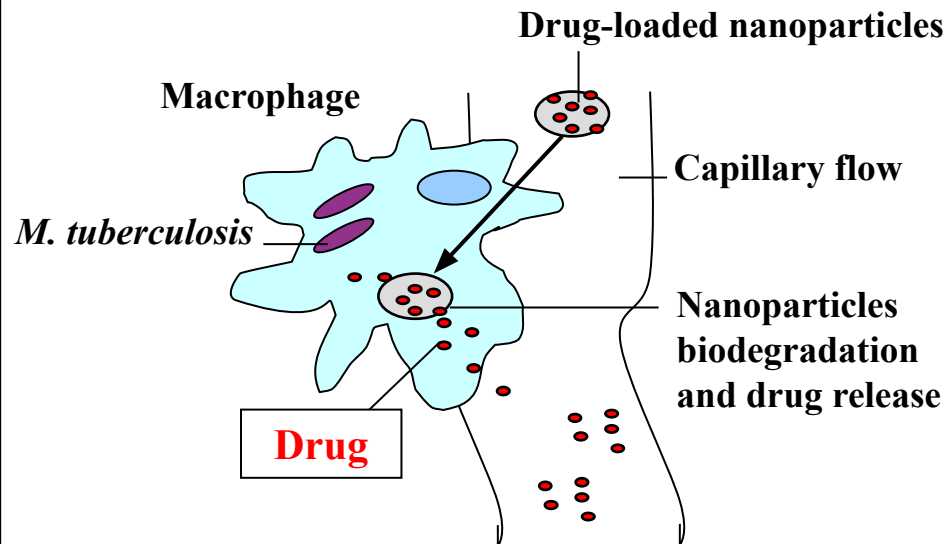

Targeting antituberculosis drugs in infected Macrophages

ACTIVITY OF MDR-PUMP

A

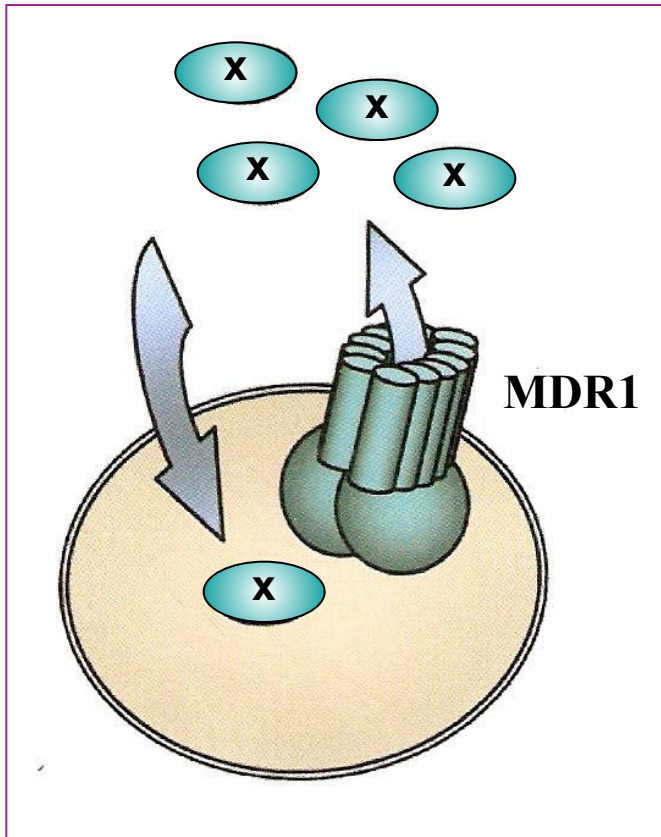

B

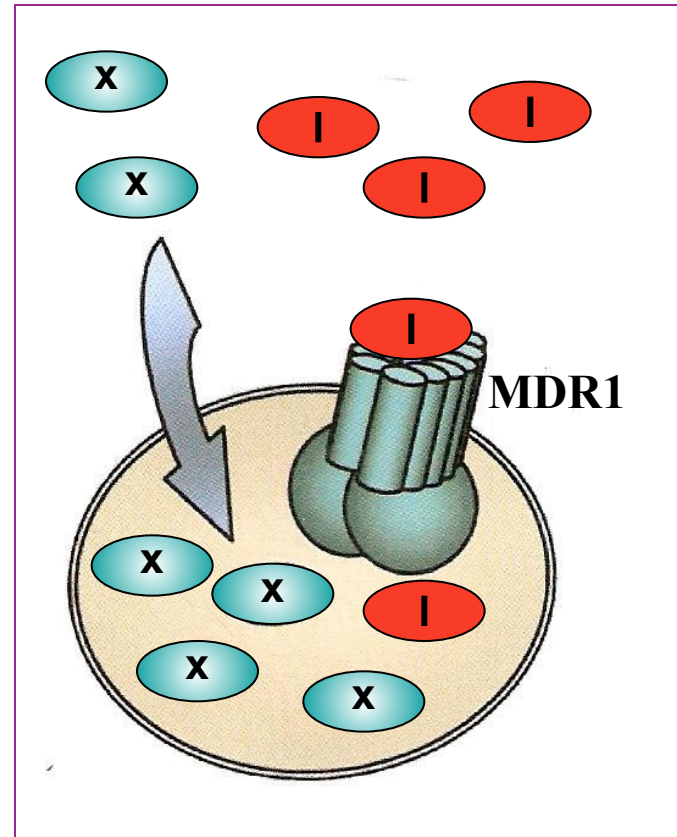

SELECTED ANTI-CANCER DRUGS THAT ARE SUBSTRATES FOR THE FACTORS RESPONSIBLE FOR MULTIDRUG RESISTANCE

Name	Substrates
Pgp	Doxorubicin, daunorubicin, epirubicin, etoposide, paclitaxel, docetaxel, vincristine, vinblastine, rhodamine-123, chloroquine, quinidine, aldosterone
MRP1	Vincristine, daunorubicin, doxorubicin, etoposide
MRP2	Methotrexate, etoposide, cisplatin, vinca alkaloids
MRP3	Etoposide, teniposide, estrogen derivatives, methotrexate, vinca alkaloids
MRP4	Purine analogues, estrogen derivates
MRP5	Thiopurines, cyclic nucleotides
GSTs	Chloroethylnitrosoureas, cisplatin, anthracyclines, phosphamides
Topo II	Chloroethylnitrosoureas, epipodophyllotoxins, cisplatin, anthracyclines