

ЛАПАРОСКОПИЯ

Основы оперативной техники и технологии





Quadro-Test

Inflation
Pressure



Intra-abdominal
Pressure



Gas Flow

1.0

l/min.

Gas Volume Used

0.9

l

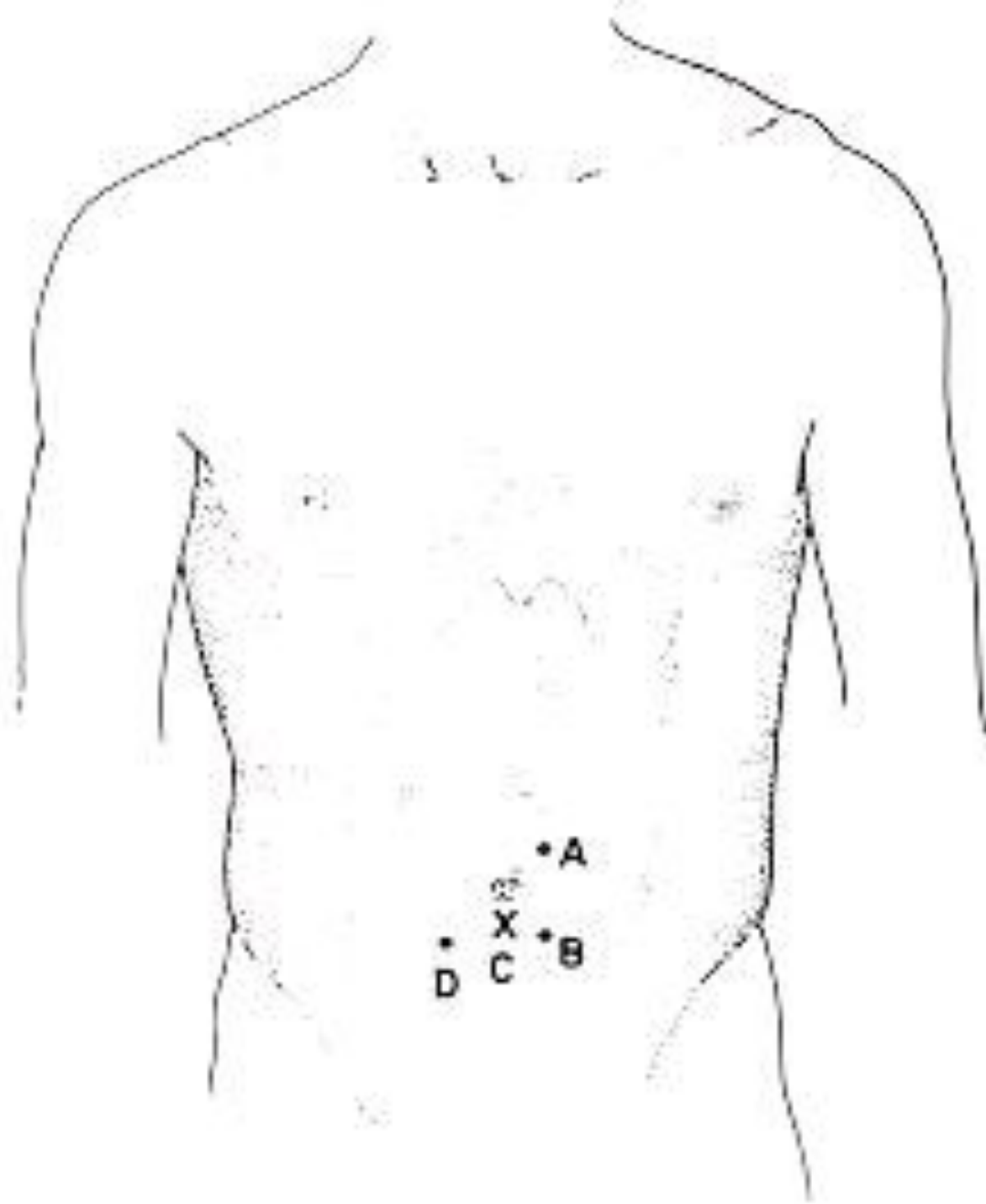

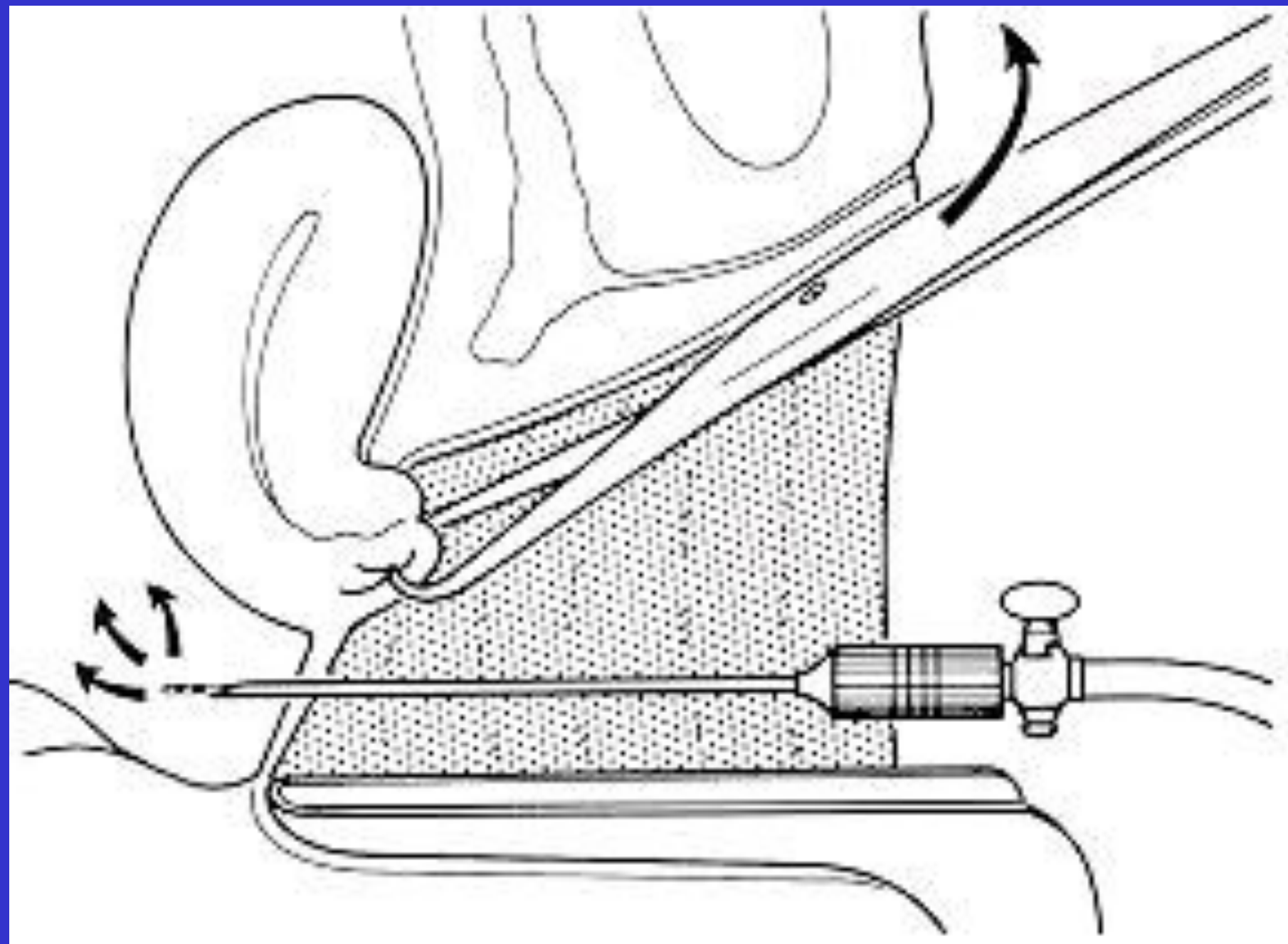





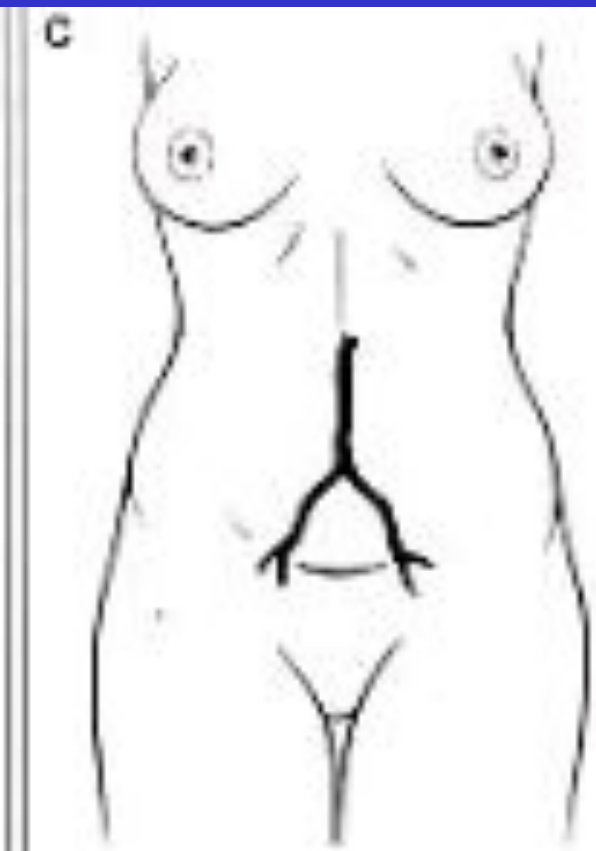
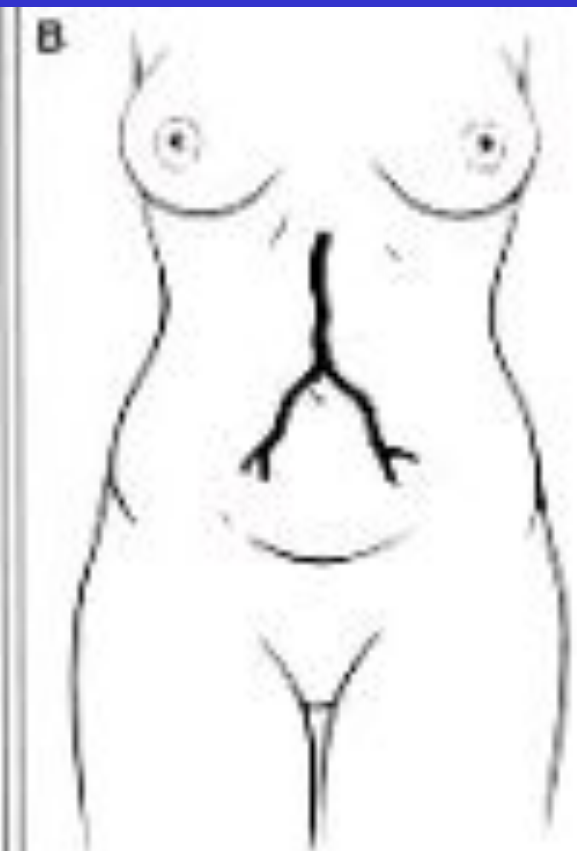
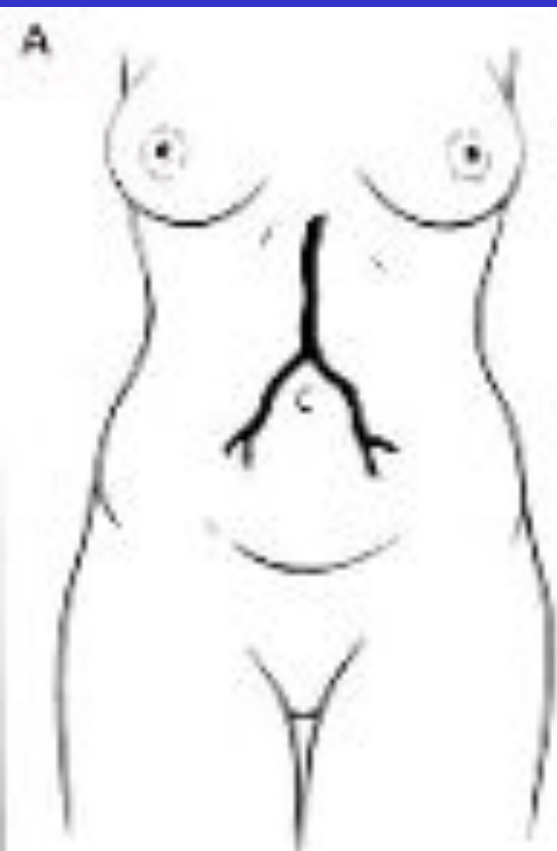



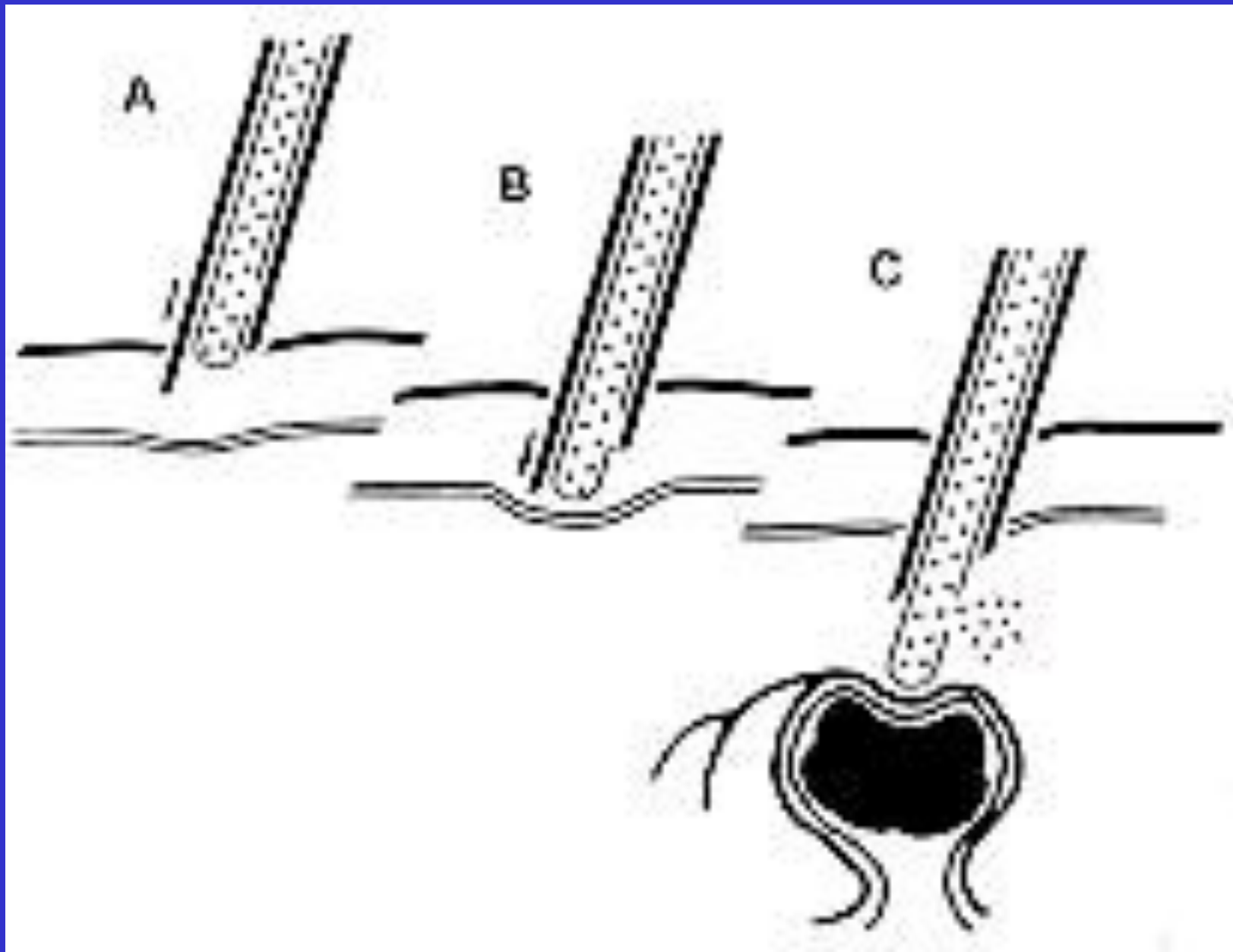



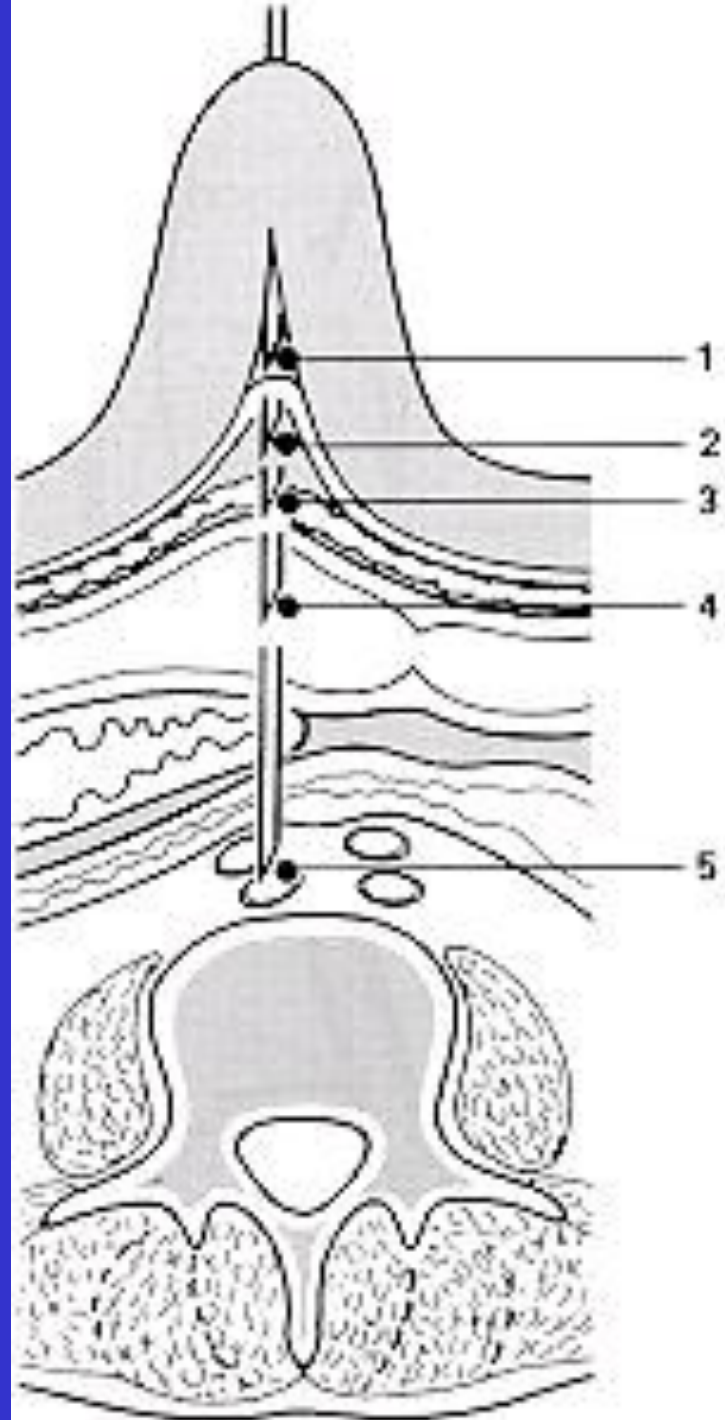



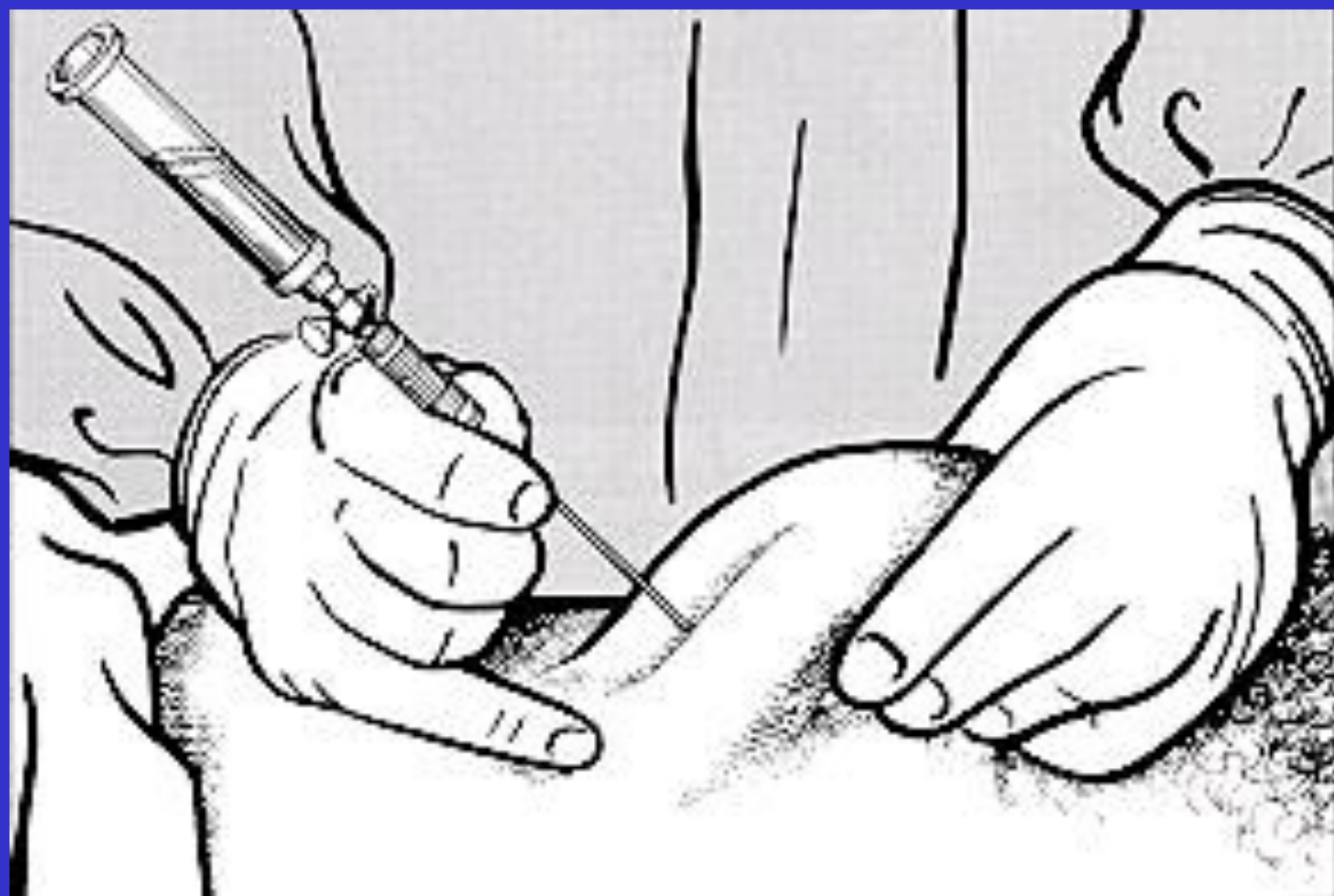

A



B



C



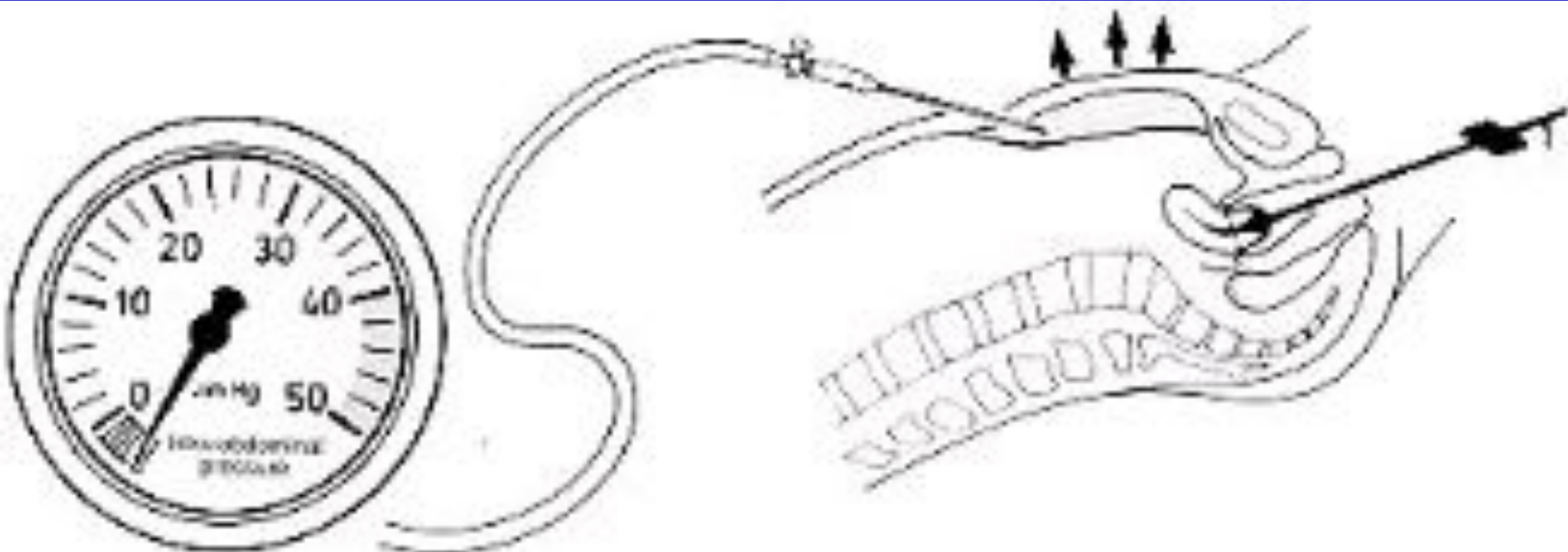

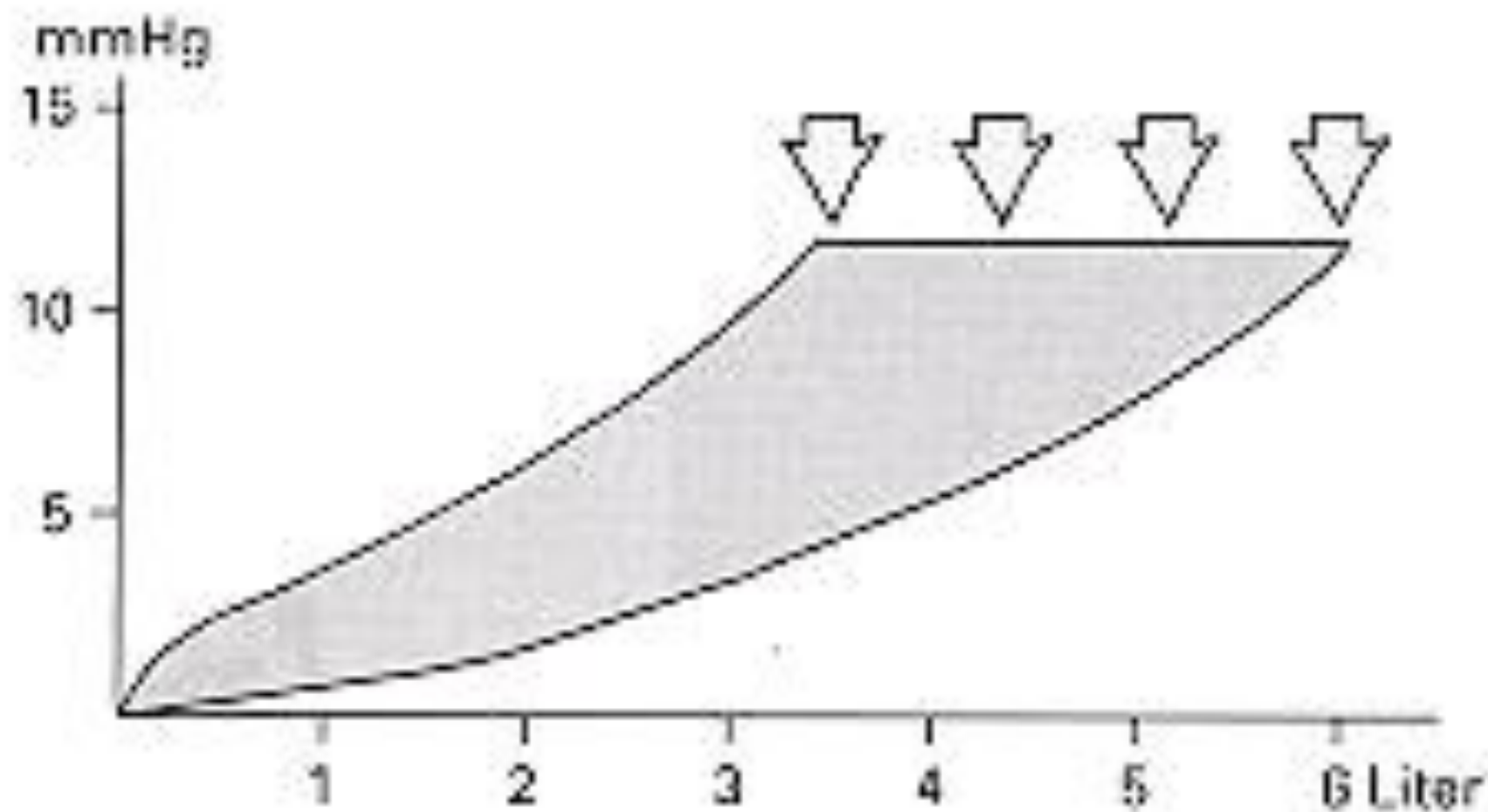



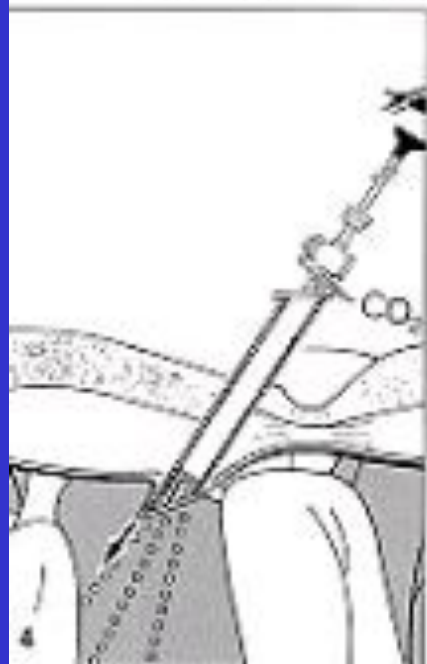
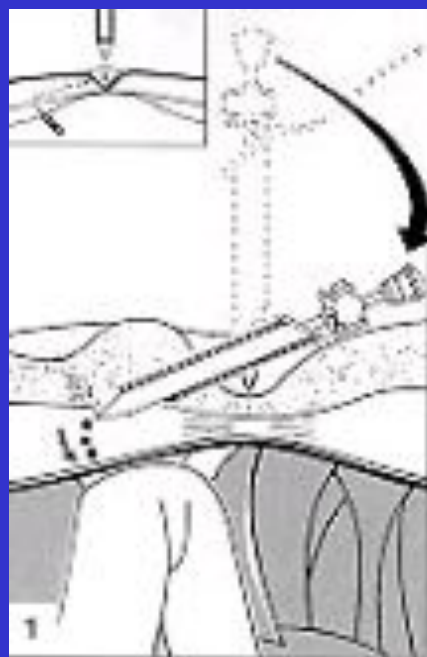

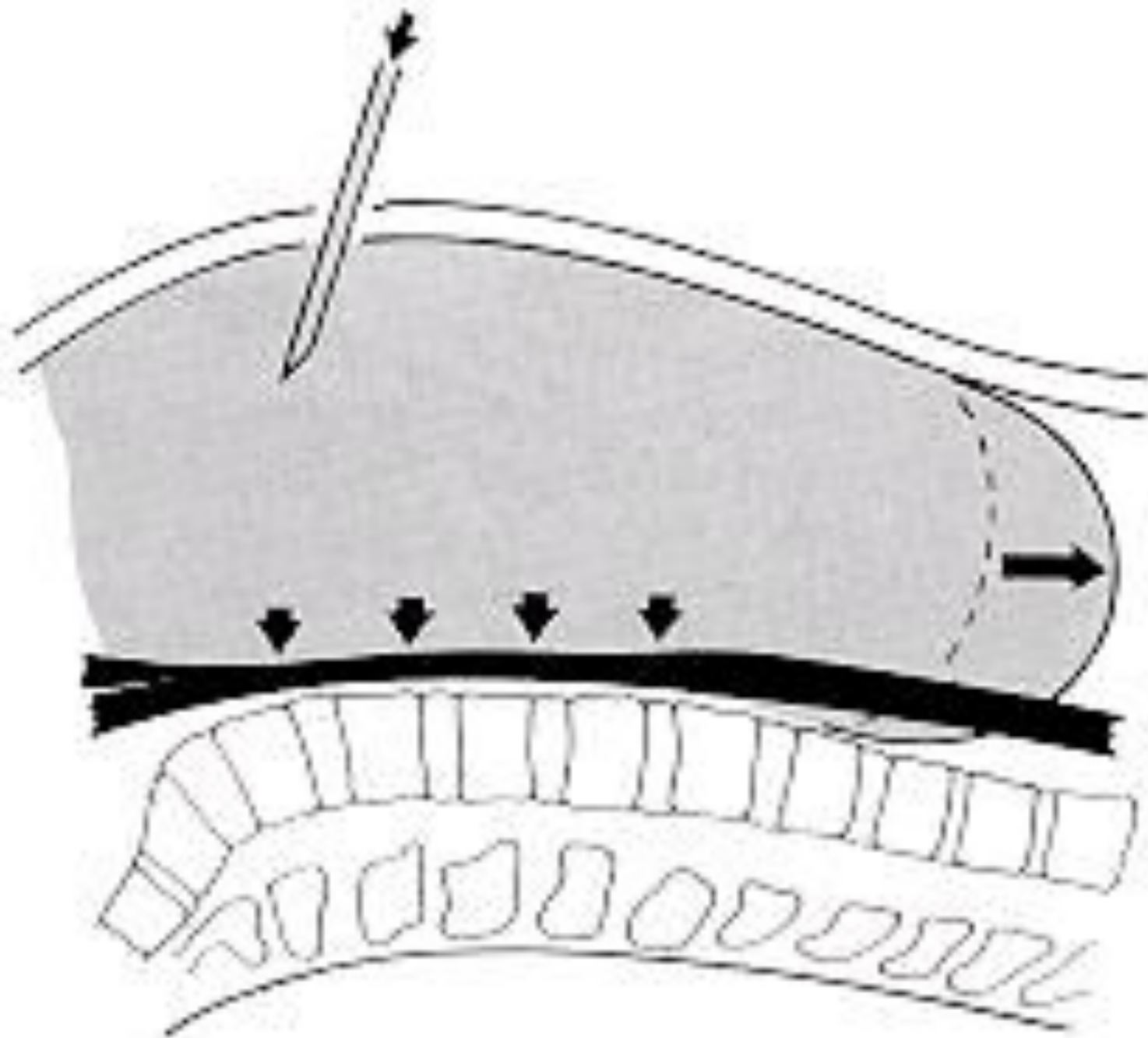



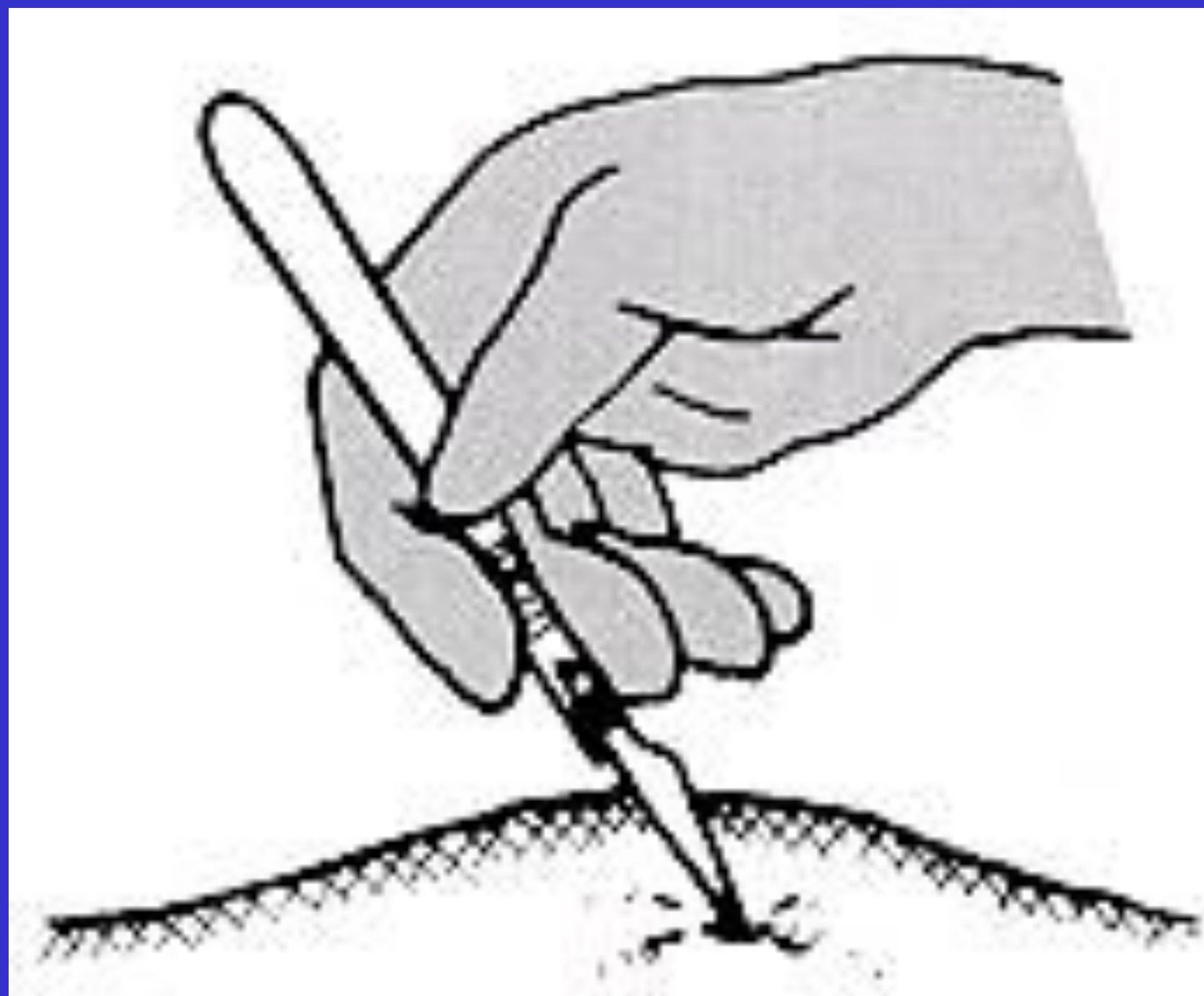



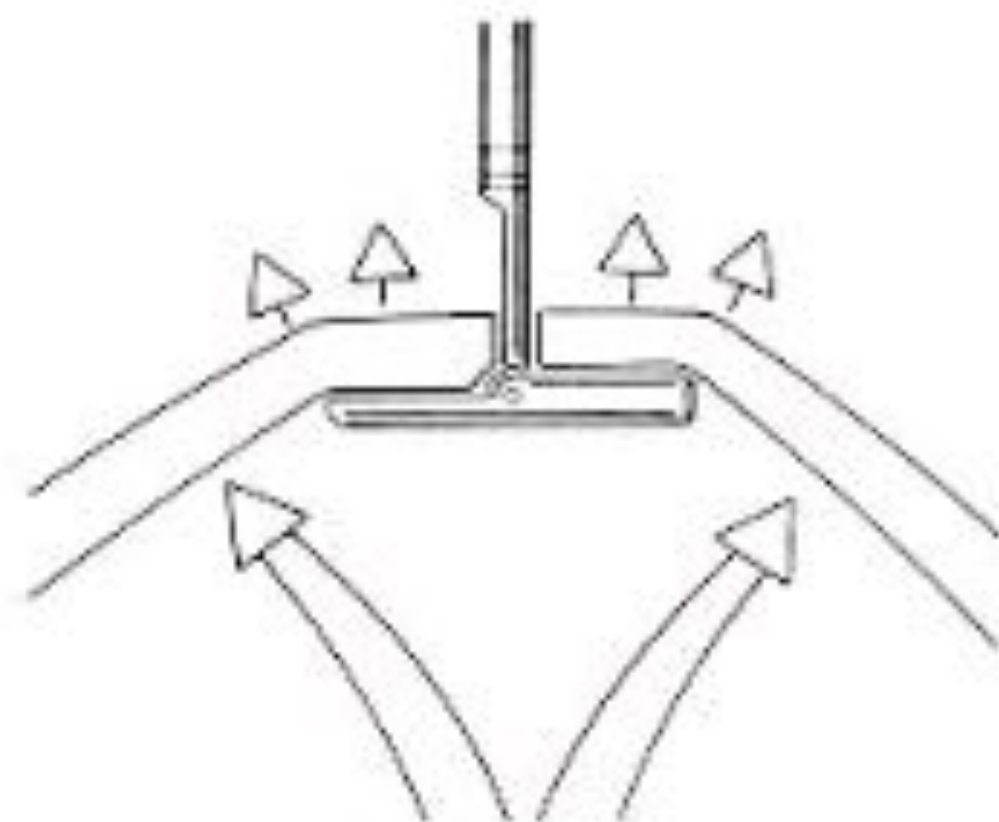
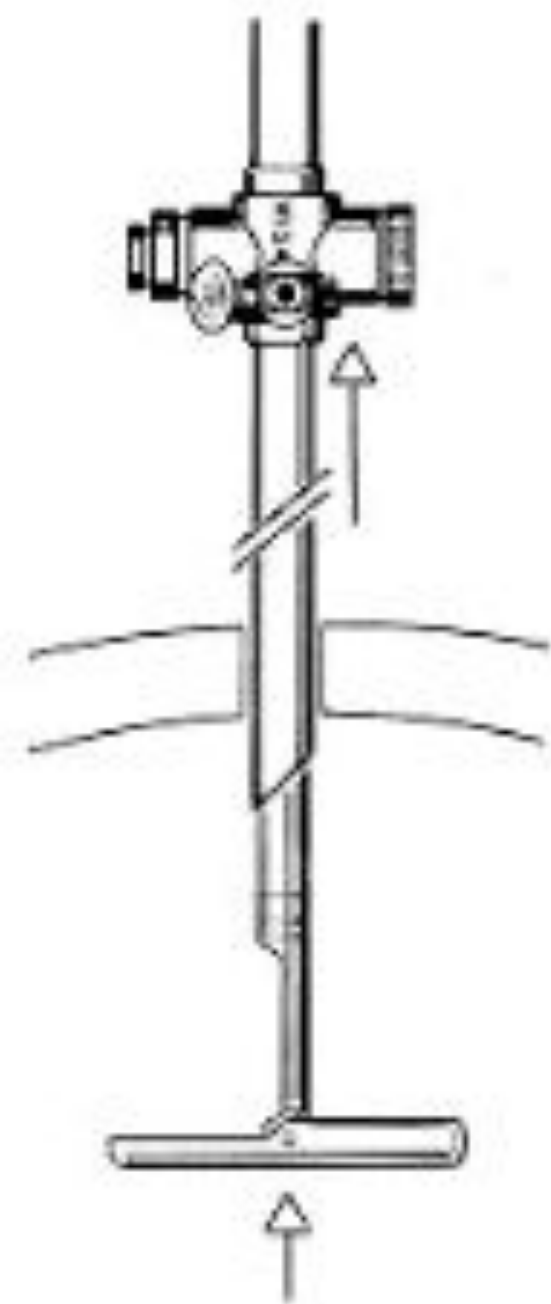

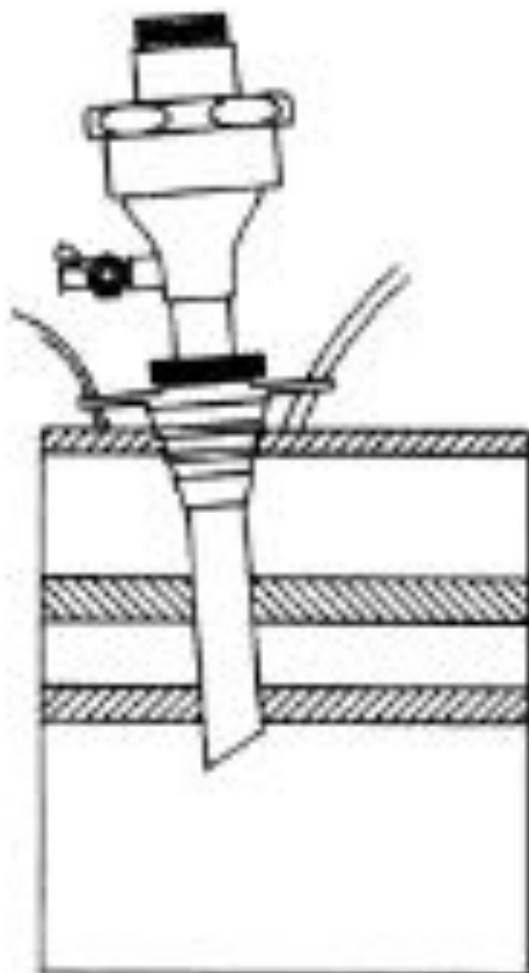
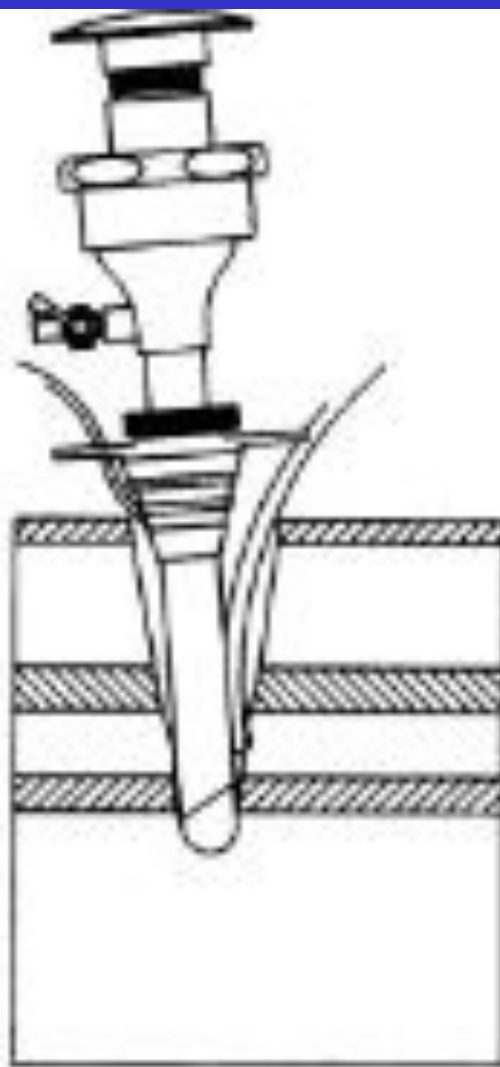
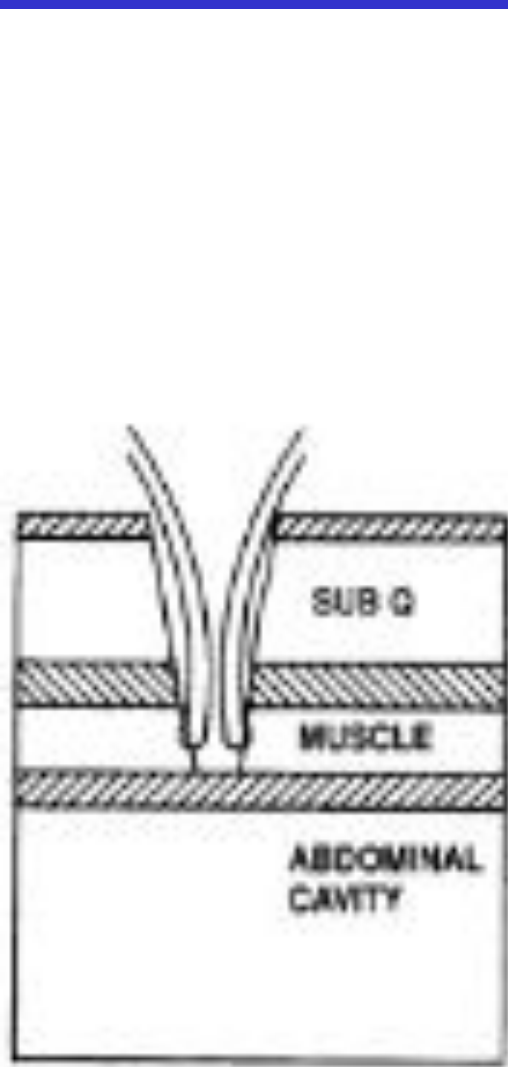





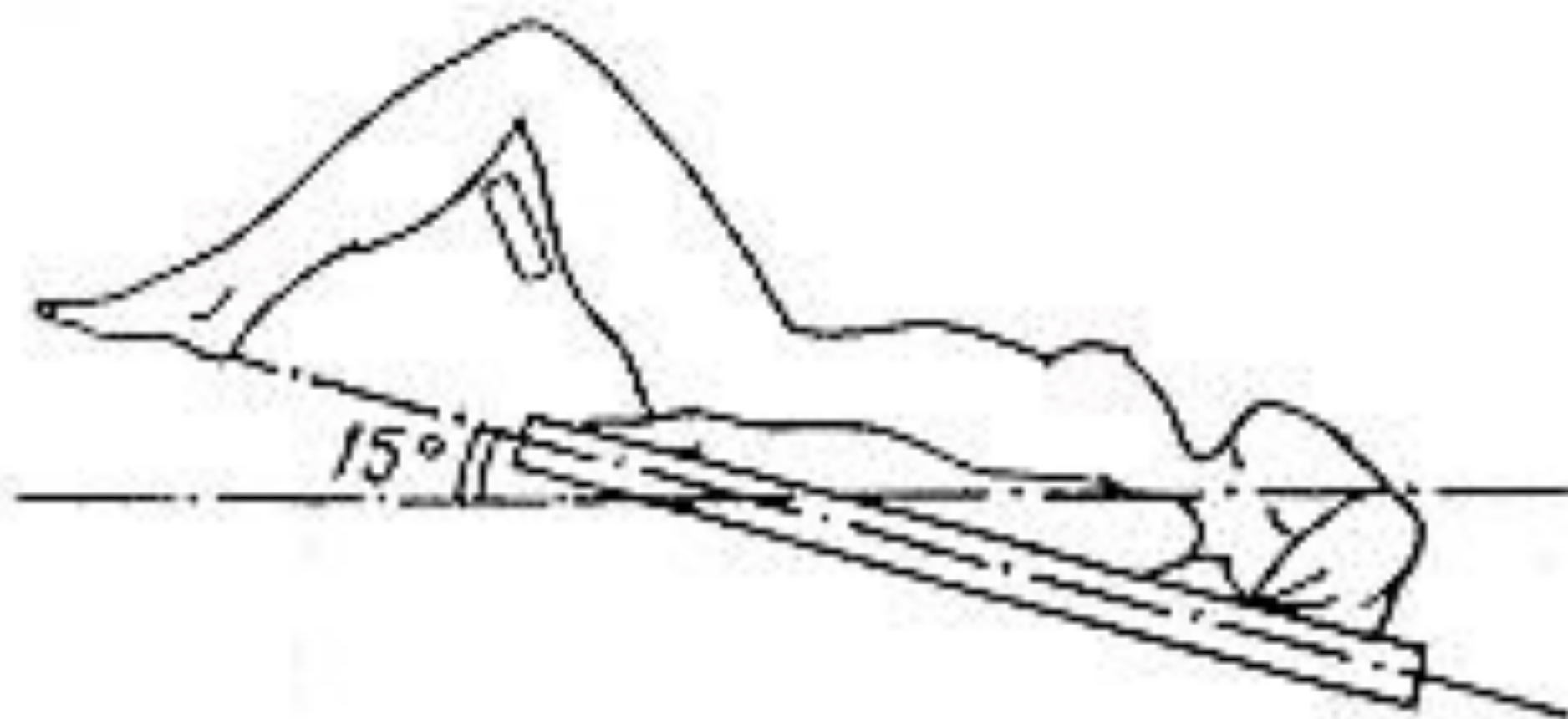

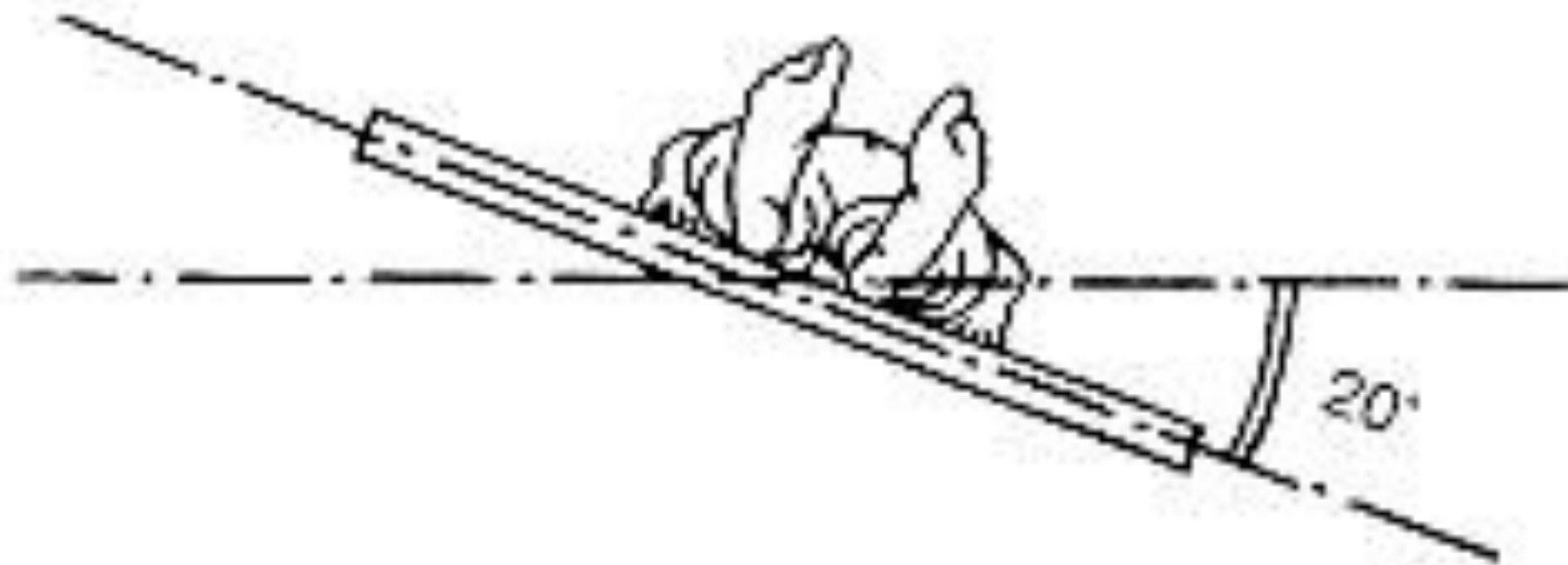

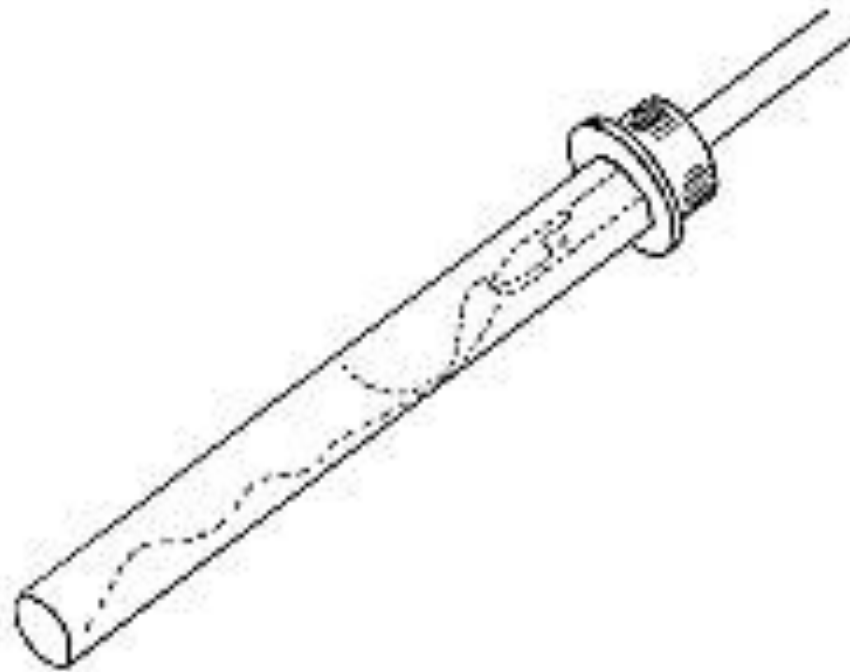
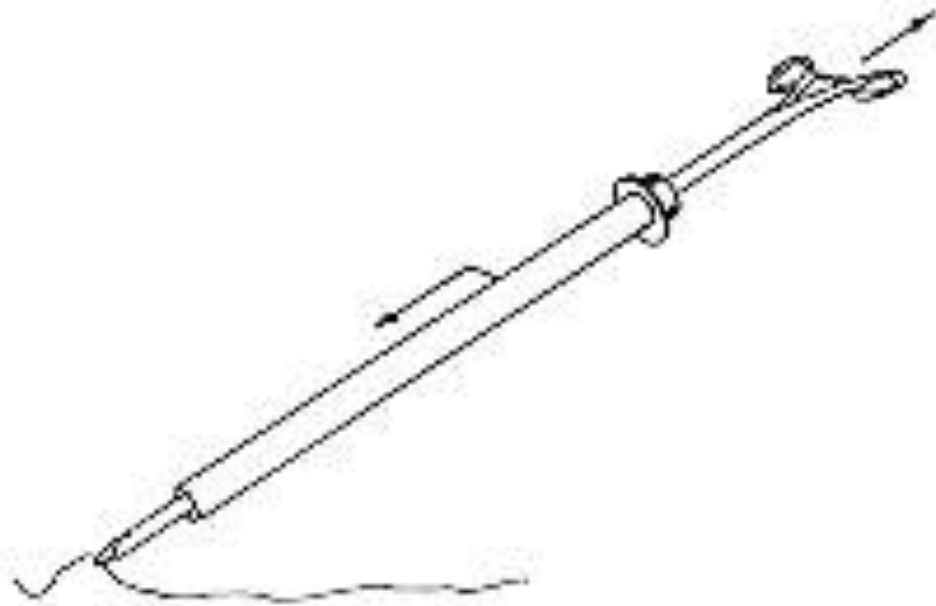



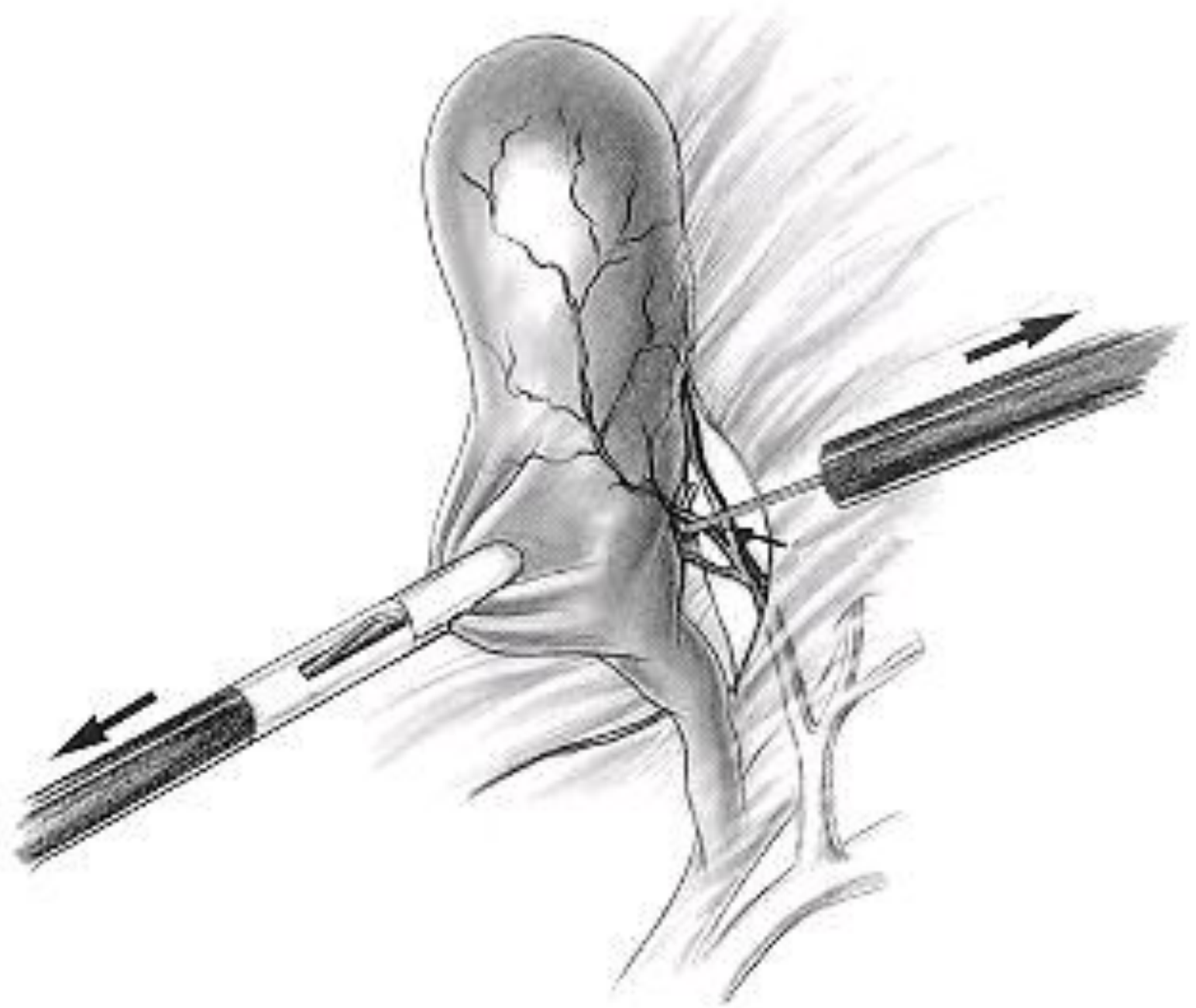



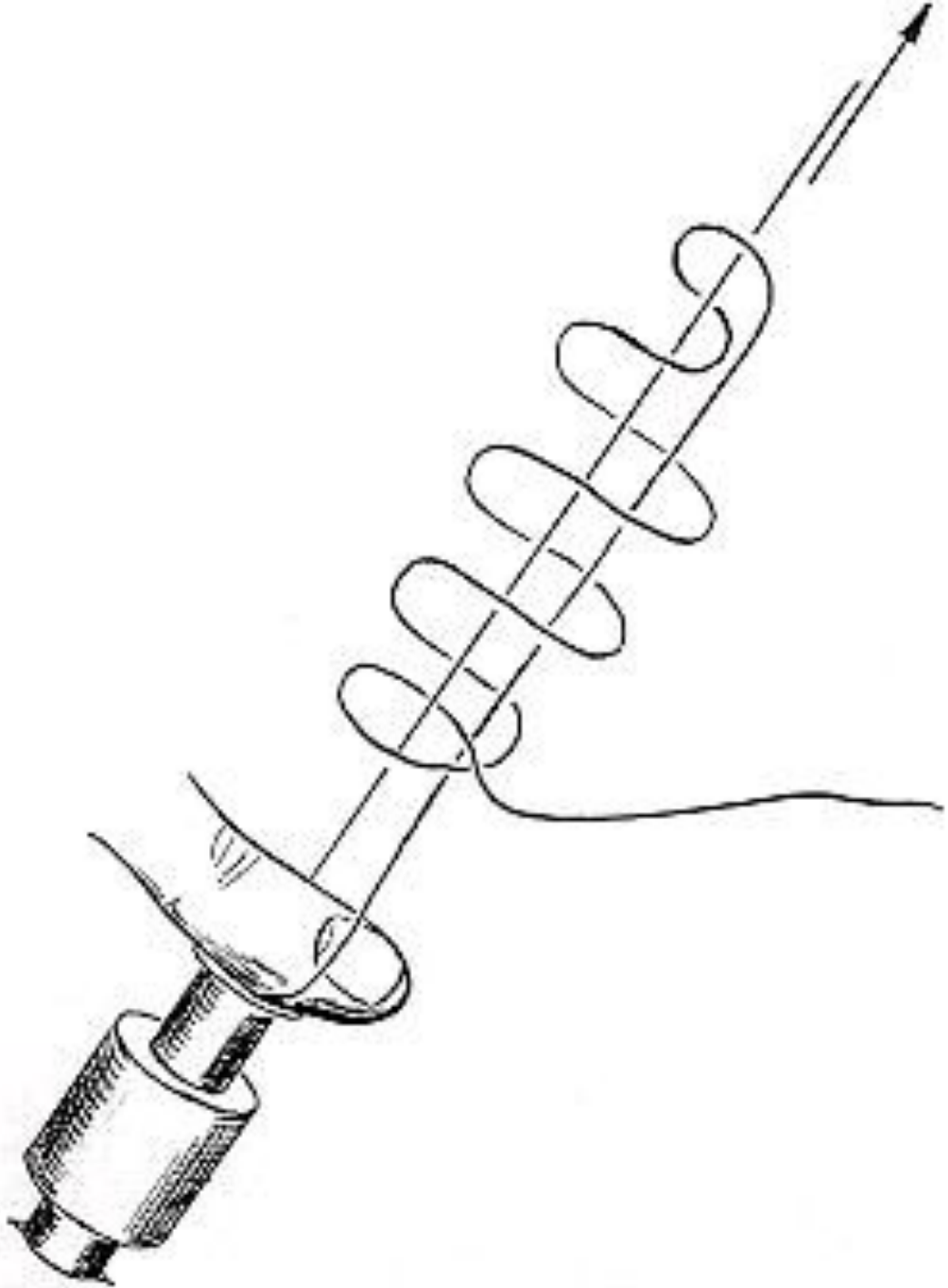

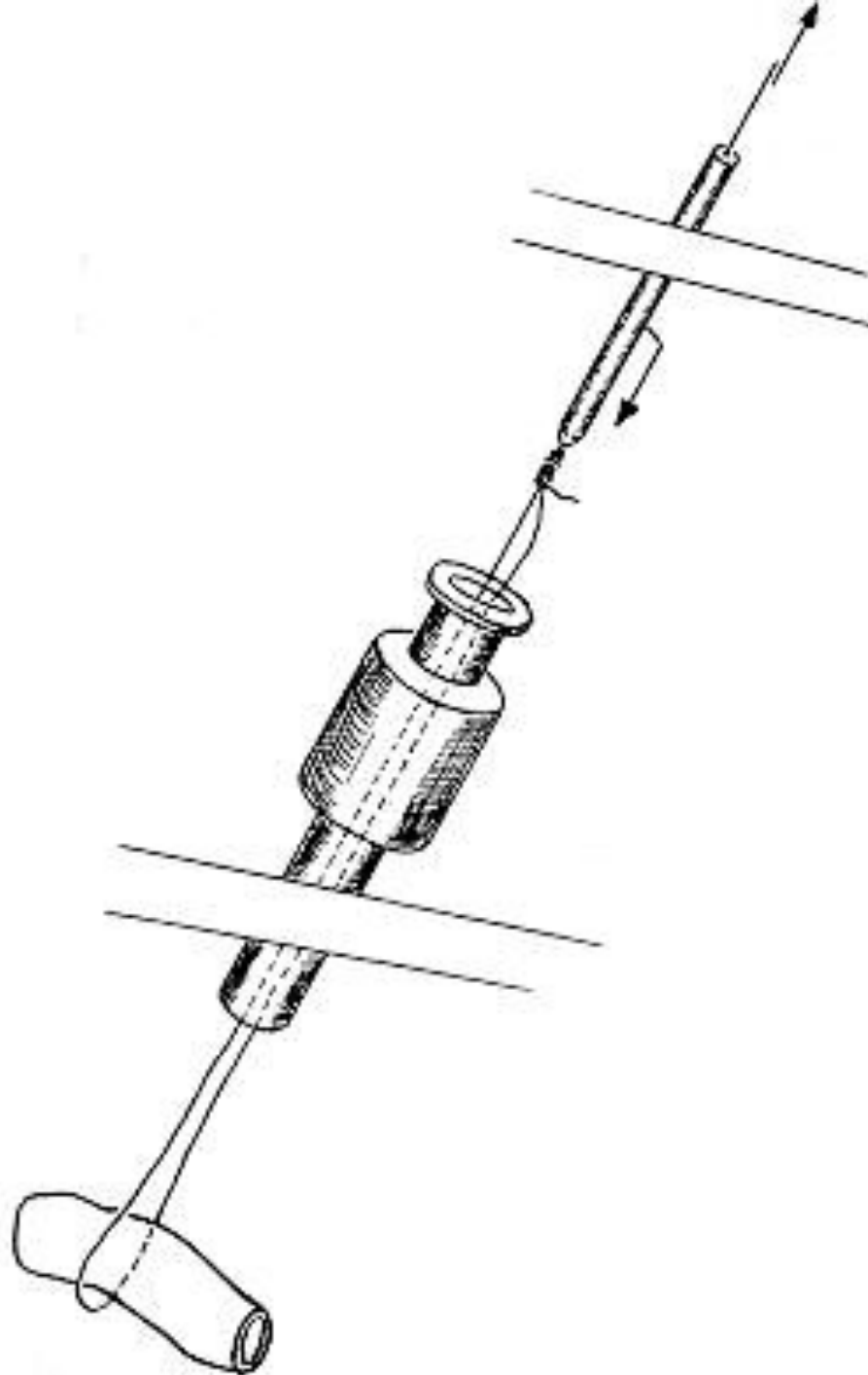

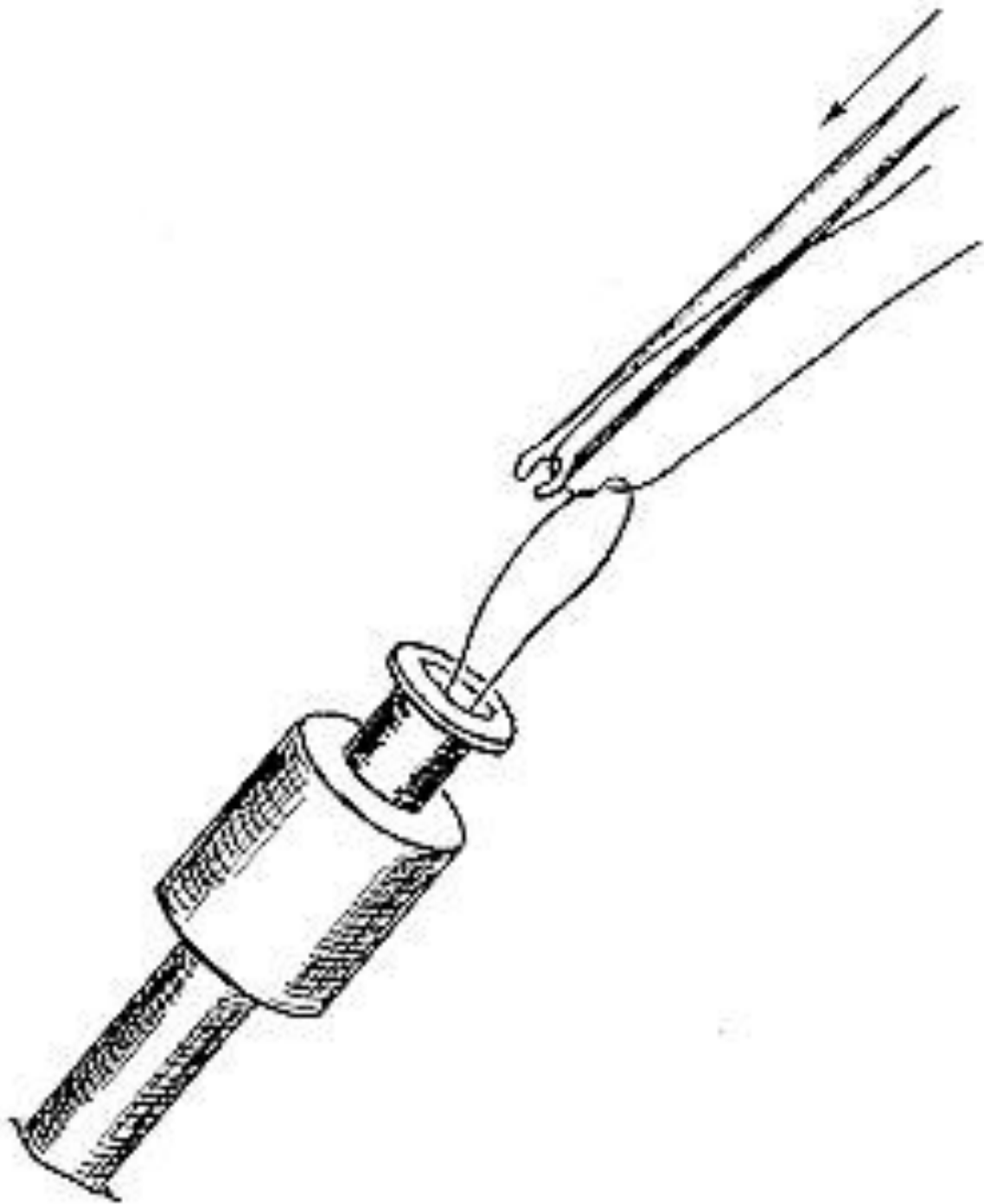



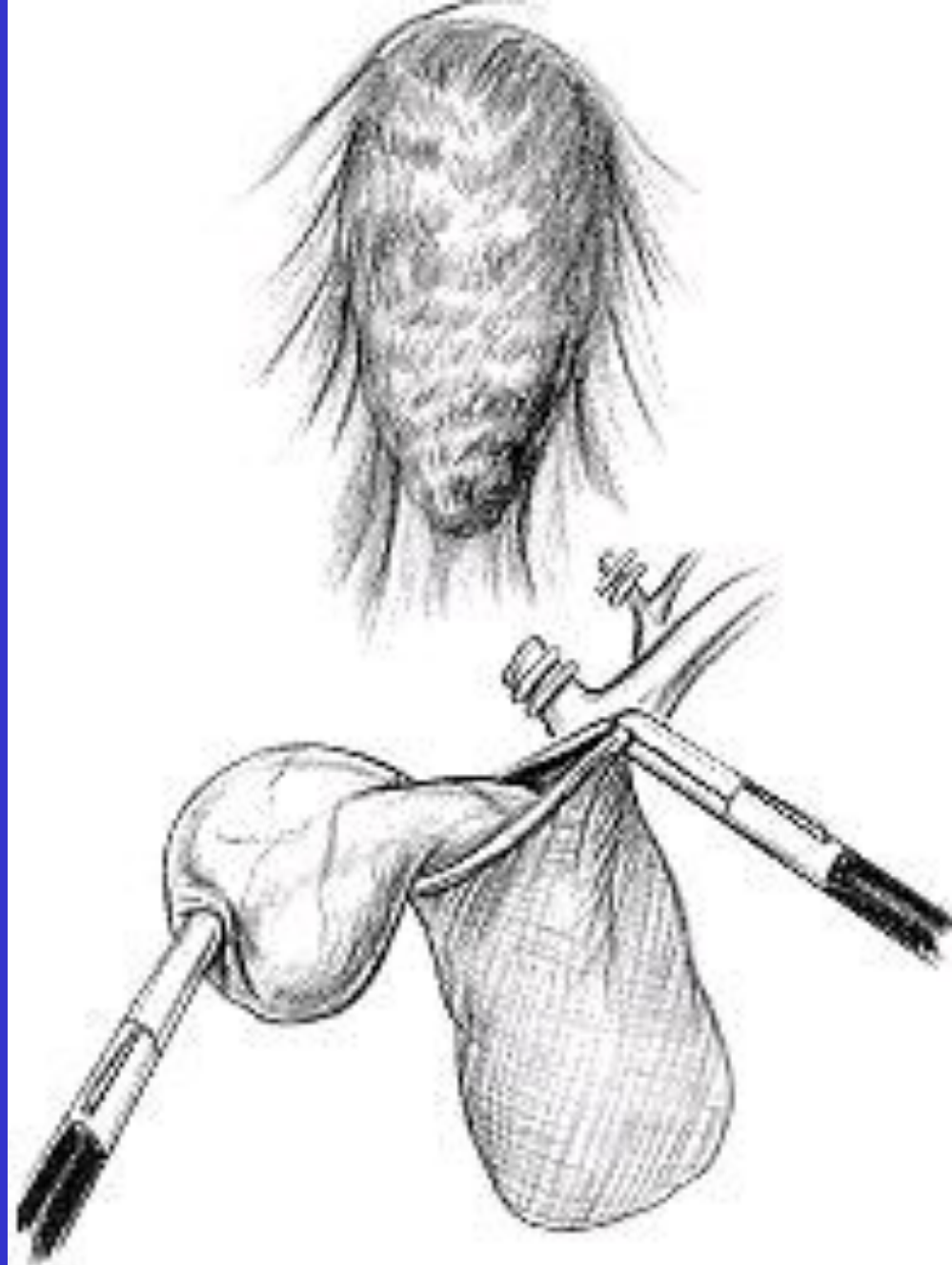

БЛАГОДАРЮ

ЗА

ВНИМАНИЕ