

**“EUROPOLIS”
RESIDENTIAL
COMPLEX**

**a fantasy
in Palladian style
traditions**

**ppt-Presentation
by Dr. Konstantin I.Samoilov,
2016**

1. The «EUROPOLIS» residential complex, J.Omarova str., Almaty city, Kazakhstan (2006-2014, arch. Konstantin I.Samoilov, “Europolis”) – the Décor Concept description



The Art concept (the wish of the Customer) – the Classicism on the Strong version (the faithful reproduction of Greece and Rome Ancient forms: the Erechtheion – Acropolis of Athens; the Tower of Winds – Athens, the Pantheon – Rome; etc.).

Author's interpretation of the customer requirements – a fantasy in the Palladian manner.

Ascending to the creativity of Andrea Palladio approach associated with the identity of all the facades of buildings, found through reflection in the architectural composition of residential houses, Restaurant, Office building, the Portico of the Main entrance, attendants pavilions). A characteristic feature of the architectural solution of façades is the use of the same elements that provide a visual unity of different size buildings.

Compositions exhibit various combinations of the Doric, Ionic, Corinthian, Composite, Tuscan and Palm-deciduous orders. The basis of facades composite solutions - the Colossal version of an Ionic colonnade.

Despite the difficult terrain with significant height differences in the linear composition, visual alignment of four-story buildings facades achieved as result of sizes uniformity of Ionic order Colonnade. Differences of landscape positions offset by different height of entablatures and pedestals, as well arcades and pilasters, which forming of first floors.

The Artistic innovation – one-volute twin capitals of the columns at blocks junction (four-storey houses).

2. The «EUROPOLIS» residential complex, J.Omarova str., Almaty city, Kazakhstan (2006-2014, arch. Konstantin I.Samoilov, “Europolis”) – the Object description



Facade decorations of identical buildings have differences in nuances. It provides a variety of views. Multi-storey buildings crowned by Belvedere domed pavilions, provides excellent panoramic views of the foothills and the city stretching from the foot of the Trans-Ili Alatau.

Four-storey buildings with mansards – reinforced concrete (walls, floors – 4 floors), steel (frames, claddings – mansard). Six-storey buildings with the mansard, a multi-level parking – steel (frames), reinforced concrete (floors, walls), foam block (walls).

Residential buildings include two-, three-, four-, five-room apartments and penthouses.

The Residential complex is in an isolated area (a feature of the landscape). The developed system of services and infrastructure. Autonomous systems of engineering support. Useful road connections to the City center.

Prospects of development – apartment buildings, a complex of world cuisine restaurants, an ethnographic park, garden-park ensemble, the entertainment and shopping Center.

This is the first example of Neoclassical forms massive use in the Kazakhstan's architecture of the 21st century (now – a popular stylistic direction in Kazakhstan's architecture).

The ppt-Presentation includes of 134 illustrations: 92 photos and 42 drawings.

3. The «EUROPOLIS» residential complex, J.Omarova str., Almaty city, Kazakhstan (2006-2014, arch. Konstantin I.Samoilov, “Europolis”) – Project participants



Source: Self-photo by K.I.Samoilov, 2016

Site Geographical position –
43°12'41.83" N, 76°58'49.95" E

Start of the Design – 2003

Opening – **Stepwise from 2006**

Architectural style –

Neo-Palladian style

Concept of the Art solution and the Space planning
– **“Europolis” Top management**

Chief Architect –

Konstantin I.Samoilov,

“Urbostyle” (2003 – 2004), “Europolis”(2004 – to date)

Chief construction design Engineer –

Alexey S.Kudriavtsev, “KAS”

(the First stage: 4-storey houses with mansards)

Max M.Weinstain, “EMK”

(the Second stage: 6-storey houses with mansards, the
Multy-level parking)

Interior decorations of Public spaces –

Konstantin I.Samoilov and Paul Chukmasov

Chief of the Architectural details Workshop –

Talgat T.Mustafin, “Europolis”

Chief advertising designer –

Andrew A.Freiburger

The «EUROPOLIS» residential complex, Almaty: a fantasy in Palladian style traditions

Ppt-Presentation by Dr. Konstantin I.Samoilov, 2016

4. The «EUROPOLIS» residential complex, J.Omarova str., Almaty city, Kazakhstan (2006-2014, arch. Konstantin I.Samoilov, “Europolis”) – the View from the Northern side



Source: Photo by K.I.Samoilov, 2016

5. The «EUROPOLIS» residential complex, J.Omarova str., Almaty city, Kazakhstan (2006-2014, arch. Konstantin I.Samoilov, “Europolis”) – the Aerospace view of the Environment



Source: the Aero-Space photo by Google Earth, 2015 (Multiple images set) - <https://www.google.com/earth/>

The «EUROPOLIS» residential complex, Almaty: a fantasy in Palladian style traditions

Ppt-Presentation by Dr. Konstantin I.Samoilov, 2016

6. The «EUROPOLIS» residential complex, J.Omarova str., Almaty city, Kazakhstan (2006-2014, arch. Konstantin I.Samoilov, “Europolis”) – the Aerospace view of the Complex



Source: the Aero-Space photo by Google Earth, 2013 - <https://www.google.com/earth/>

7. The «EUROPOLIS» residential complex, J.Omarova str., Almaty city, Kazakhstan (2006-2014, arch. Konstantin I.Samoilov, «Europolis») – the main objects Position

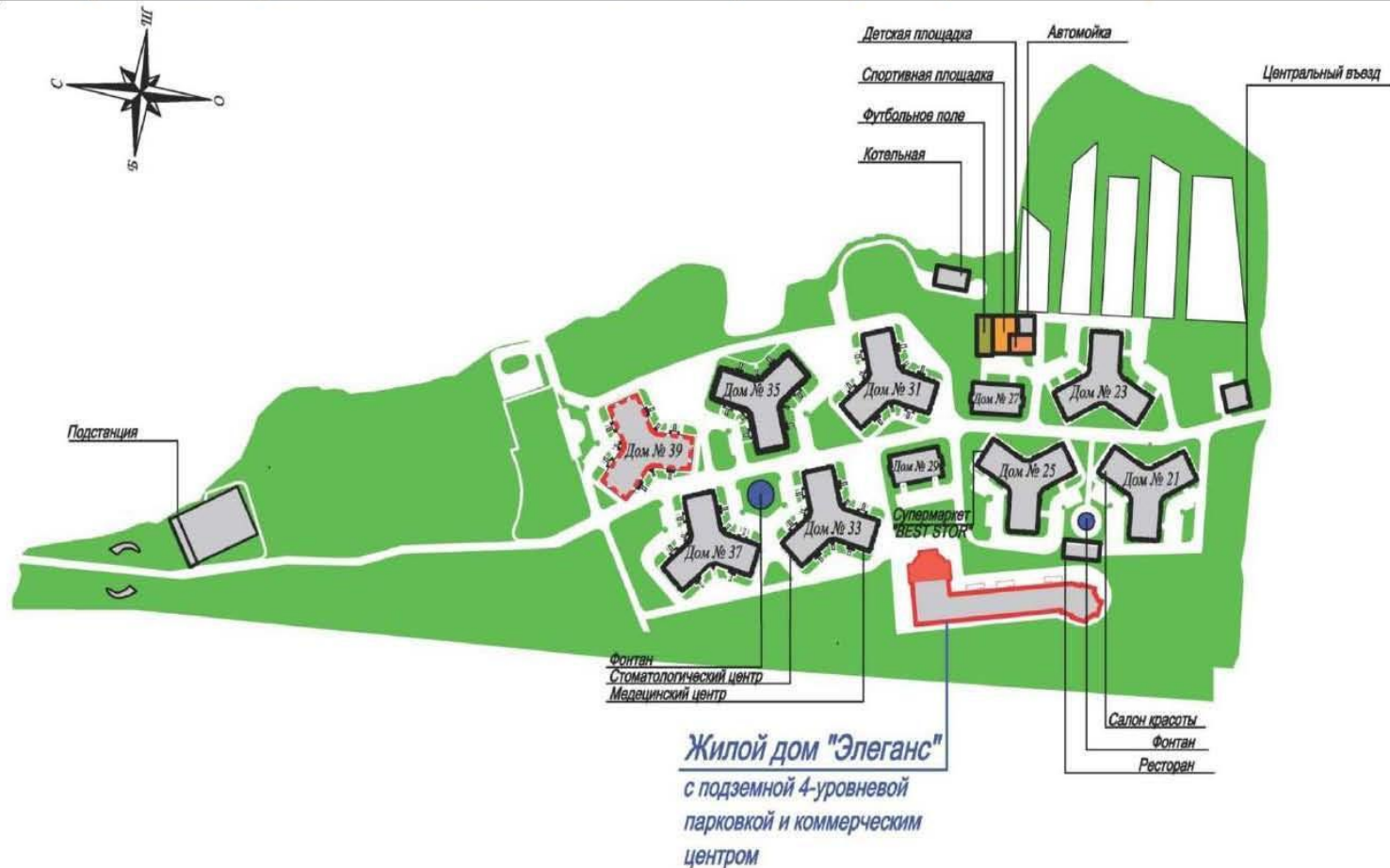

8. The «EUROPOLIS» residential complex, J.Omarova str., Almaty city, Kazakhstan
(2006-2014, arch. Konstantin I.Samoilov, «Europolis») – the Park pavilion and the Main entrance

Благоустройство
комплекса



Центральный
въезд



The «EUROPOLIS» residential complex, Almaty: a fantasy in Palladian style traditions

Ppt-Presentation by Dr. Konstantin I.Samoilov, 2016

9. The «EUROPOLIS» residential complex, J.Omarova str., Almaty city, Kazakhstan (2006-2014, arch. Konstantin I.Samoilov, “Europolis”) – the Waymark, the Sculpture of the Main entrance



Source: Photos by K.I.Samoilov, 2016

The «EUROPOLIS» residential complex, Almaty: a fantasy in Palladian style traditions

Ppt-Presentation by Dr. Konstantin I.Samoilov, 2016

**10. The «EUROPOLIS» residential complex, J.Omarova str., Almaty city, Kazakhstan
(2006-2014, arch. Konstantin I.Samoilov, “Europolis”) – the Twin ring-Composition of the Main entrance**



Source: Photo by K.I.Samoilov, 2016

The «EUROPOLIS» residential complex, Almaty: a fantasy in Palladian style traditions

Ppt-Presentation by Dr. Konstantin I.Samoilov, 2016

11. The «EUROPOLIS» residential complex, J.Omarova str., Almaty city, Kazakhstan
(2006-2014, arch. Konstantin I.Samoilov, «Europolis») – the Twin ring-Composition of the Main entrance



Source: Photos by K.I.Samoilov, 2016

The «EUROPOLIS» residential complex, Almaty: a fantasy in Palladian style traditions

Ppt-Presentation by Dr. Konstantin I.Samoilov, 2016

12. The «EUROPOLIS» residential complex, J.Omarova str., Almaty city, Kazakhstan
(2006-2014, arch. Konstantin I.Samoilov, “Europolis”) – the Southern Gate



Source: Photo by K.I.Samoilov, 2016

The «EUROPOLIS» residential complex, Almaty: a fantasy in Palladian style traditions

Ppt-Presentation by Dr. Konstantin I.Samoilov, 2016

**13. The «EUROPOLIS» residential complex, J.Omarova str., Almaty city, Kazakhstan
(2006-2014, arch. Konstantin I.Samoilov, “Europolis”) – the Service building**



Source: Photo by K.I.Samoilov, 2016

The «EUROPOLIS» residential complex, Almaty: a fantasy in Palladian style traditions

Ppt-Presentation by Dr. Konstantin I.Samoilov, 2016

14. The «EUROPOLIS» residential complex, J.Omarova str., Almaty city, Kazakhstan (2006-2014, arch. Konstantin I.Samoilov, “Europolis”) – the Main street



Source: Photo by K.I.Samoilov, 2016

15. The «EUROPOLIS» residential complex, J.Omarova str., Almaty city, Kazakhstan (2006-2014, arch. Konstantin I.Samoilov, “Europolis”) – a Sectional view (Buildings 1-5), a Floor plan (Building 2)

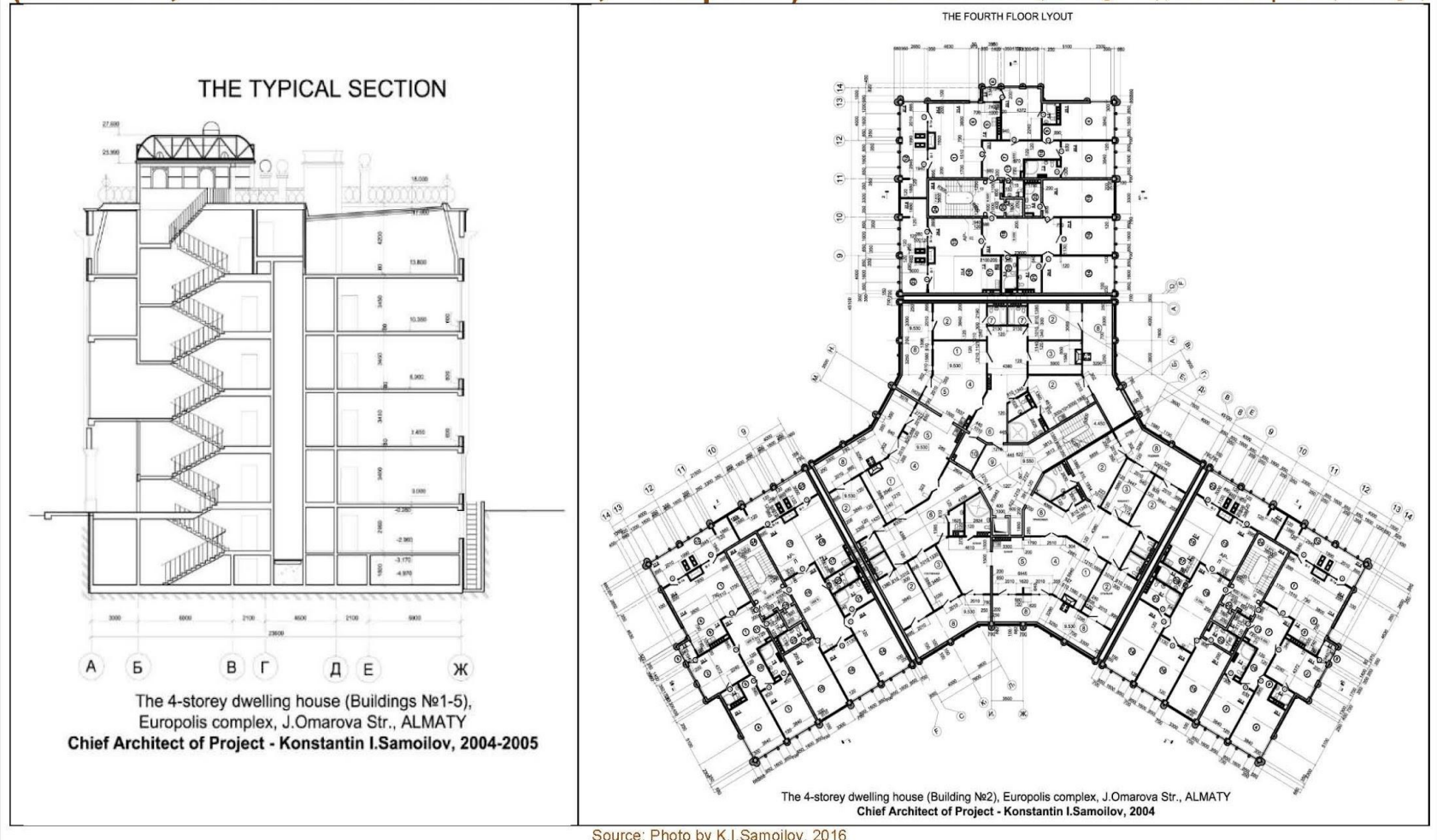

The «EUROPOLIS» residential complex, Almaty: a fantasy in Palladian style traditions

Ppt-Presentation by Dr. Konstantin I. Samoilov, 2016

**16. The «EUROPOLIS» residential complex, J.Omarova str., Almaty city, Kazakhstan
(2006-2014, arch. Konstantin I.Samoilov, “Europolis”) – the Building 1 (street №23)**



Source: Photo by K.I. Samoilov, 2015

17. The «EUROPOLIS» residential complex, J.Omarova str., Almaty city, Kazakhstan
(2006-2014, arch. Konstantin I.Samoilov, “Europolis”) – the Building 2 façade (street №21)

THE MAIN FACADE



The 4-storey dwelling house (Building №2), Europolis complex, J.Omarova Str., ALMATY
Chief Architect of Project - Konstantin I.Samoilov, 2004

The «EUROPOLIS» residential complex, Almaty: a fantasy in Palladian style traditions

Ppt-Presentation by Dr. Konstantin I.Samoilov, 2016

**18. The «EUROPOLIS» residential complex, J.Omarova str., Almaty city, Kazakhstan
(2006-2014, arch. Konstantin I.Samoilov, “Europolis”) – the Building 2 (street №21)**



Source: Photo by K.I. Samoilov, 2015

The «EUROPOLIS» residential complex, Almaty: a fantasy in Palladian style traditions

Ppt-Presentation by Dr. Konstantin I.Samoilov, 2016

**19. The «EUROPOLIS» residential complex, J.Omarova str., Almaty city, Kazakhstan
(2006-2014, arch. Konstantin I.Samoilov, “Europolis”) – the Building 1 (street №23)**



Source: Photo by K.I.Samoilov, 2015

The «EUROPOLIS» residential complex, Almaty: a fantasy in Palladian style traditions

Ppt-Presentation by Dr. Konstantin I.Samoilov, 2016

20. The «EUROPOLIS» residential complex, J.Omarova str., Almaty city, Kazakhstan
(2006-2014, arch. Konstantin I.Samoilov, “Europolis”) – the Building 1 (street №23)



Source: Photos by K.I.Samoilov, 2016

The «EUROPOLIS» residential complex, Almaty: a fantasy in Palladian style traditions

Ppt-Presentation by Dr. Konstantin I.Samoilov, 2016

21. The «EUROPOLIS» residential complex, J.Omarova str., Almaty city, Kazakhstan
(2006-2014, arch. Konstantin I.Samoilov, «Europolis») – the Staircase hall (the Building 1)

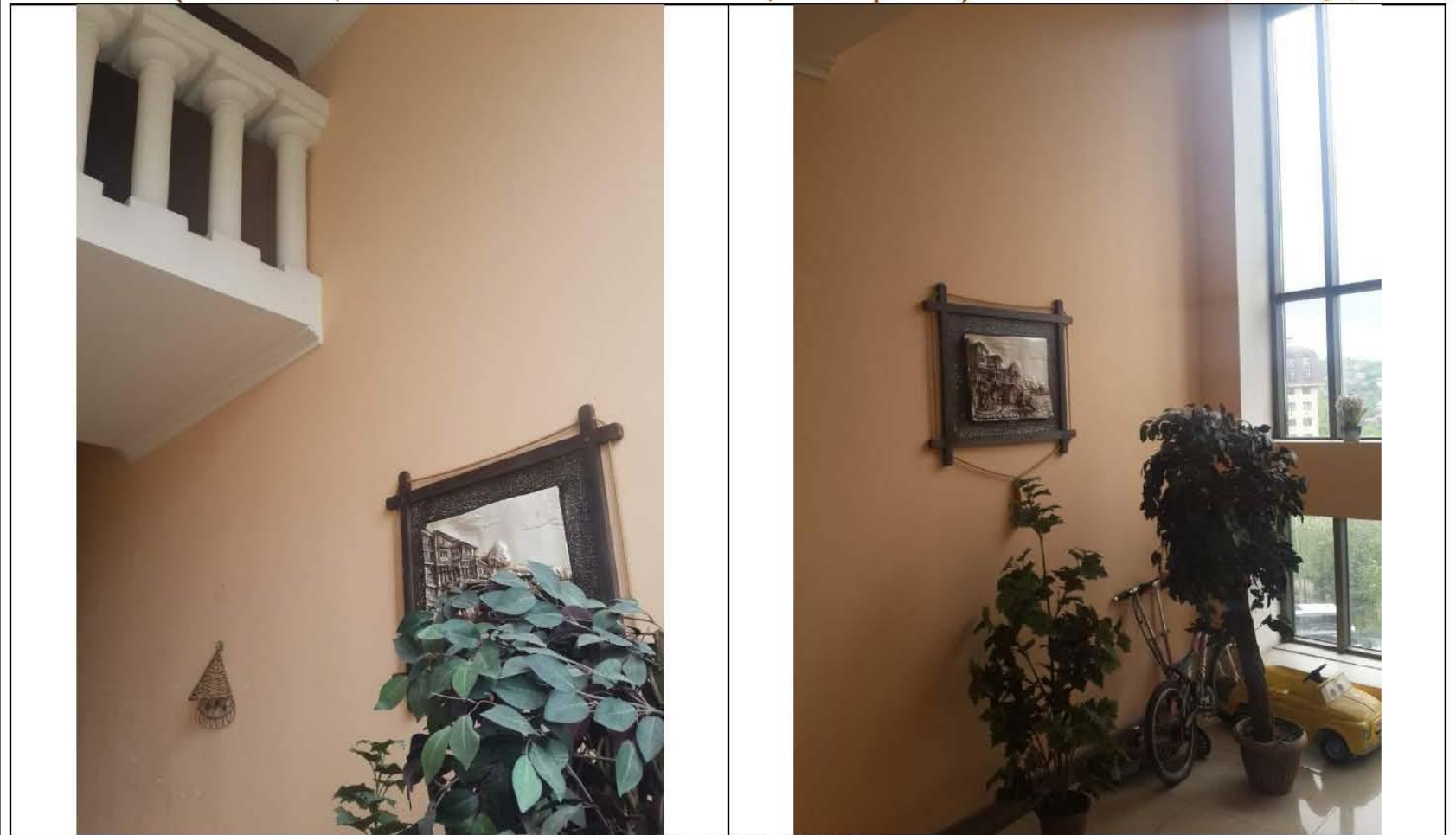

Source: Photos by K.I.Samoilov, 2016

The «EUROPOLIS» residential complex, Almaty: a fantasy in Palladian style traditions

Ppt-Presentation by Dr. Konstantin I.Samoilov, 2016

22. The «EUROPOLIS» residential complex, J.Omarova str., Almaty city, Kazakhstan
(2006-2014, arch. Konstantin I.Samoilov, «Europolis») – the Staircase hall (the Building 1)

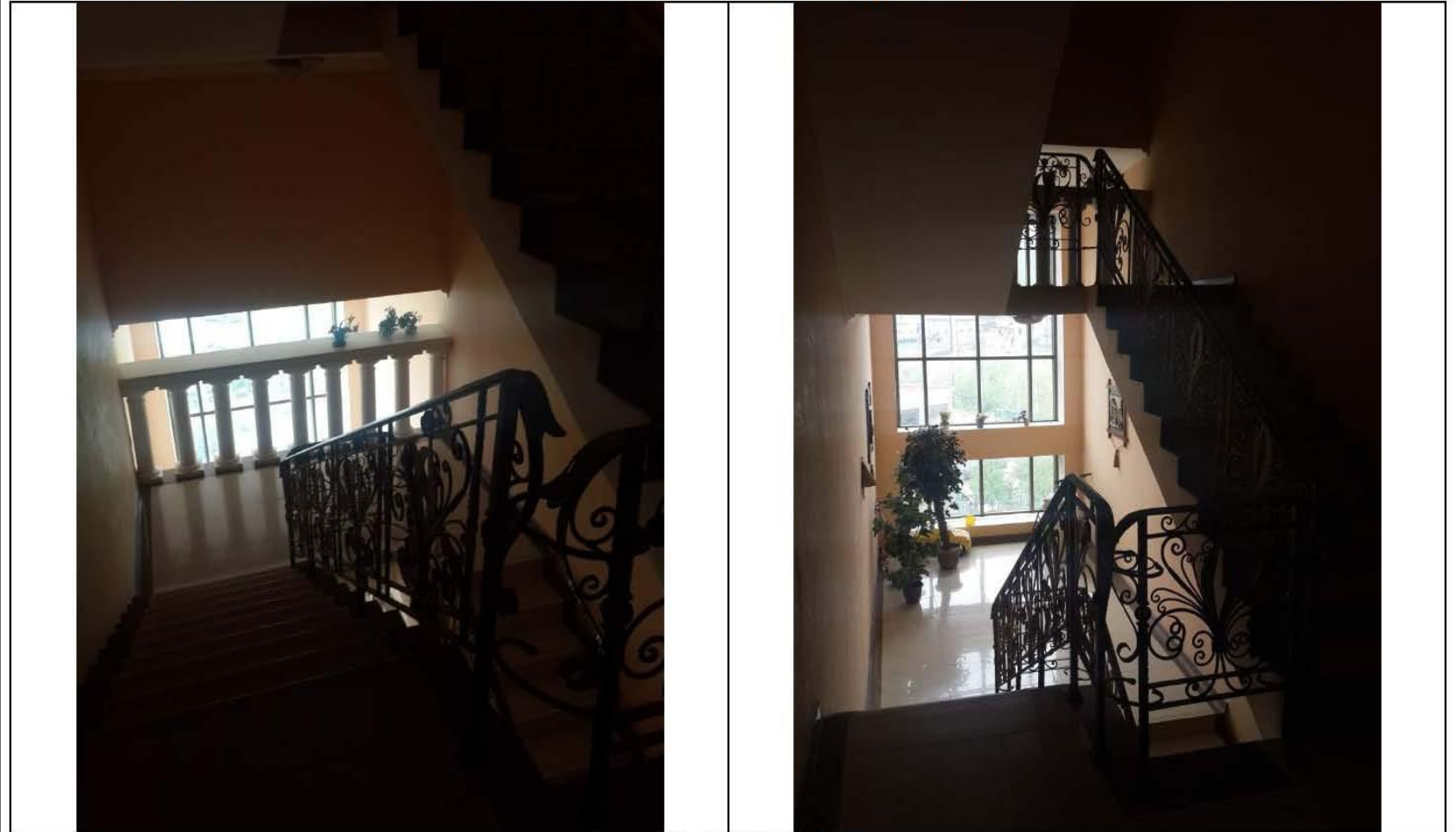

Source: Photos by K.I.Samoilov, 2016

The «EUROPOLIS» residential complex, Almaty: a fantasy in Palladian style traditions

Ppt-Presentation by Dr. Konstantin I.Samoilov, 2016

23. The «EUROPOLIS» residential complex, J.Omarova str., Almaty city, Kazakhstan
(2006-2014, arch. Konstantin I.Samoilov, “Europolis”) – the Building 2 (street №21)



Source: Photo by K.I.Samoilov, 2016

The «EUROPOLIS» residential complex, Almaty: a fantasy in Palladian style traditions

Ppt-Presentation by Dr. Konstantin I.Samoilov, 2016

**24. The «EUROPOLIS» residential complex, J.Omarova str., Almaty city, Kazakhstan
(2006-2014, arch. Konstantin I.Samoilov, “Europolis”) – the Building 1 (street №23)**



Source: Photo by K.I.Samoilov, 2016

**25. The «EUROPOLIS» residential complex, J.Omarova str., Almaty city, Kazakhstan
(2006-2014, arch. Konstantin I.Samoilov, “Europolis”) – the Building 3 façade (street №25)**

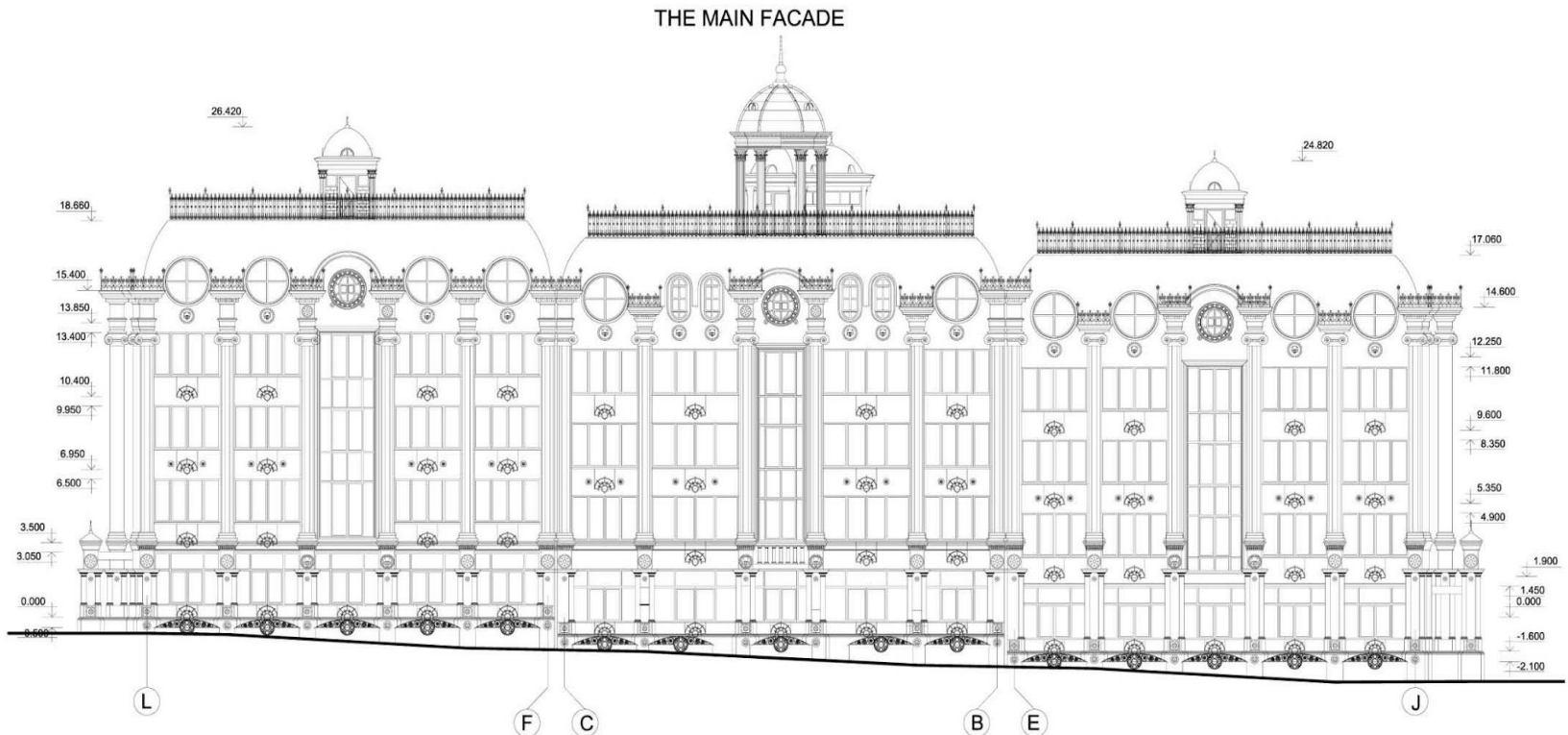

The 4-storey dwelling house (Building №3), Europolis complex, J.Omarova Str., ALMATY
Chief Architect of Project - Konstantin I.Samoilov, 2005

The «EUROPOLIS» residential complex, Almaty: a fantasy in Palladian style traditions

Ppt-Presentation by Dr. Konstantin I.Samoilov, 2016

26. The «EUROPOLIS» residential complex, J.Omarova str., Almaty city, Kazakhstan
(2006-2014, arch. Konstantin I.Samoilov, “Europolis”) – the Building 3 (street №25)



Source: Photo by K.I. Samoilov, 2016

The «EUROPOLIS» residential complex, Almaty: a fantasy in Palladian style traditions

Ppt-Presentation by Dr. Konstantin I.Samoilov, 2016

**27. The «EUROPOLIS» residential complex, J.Omarova str., Almaty city, Kazakhstan
(2006-2014, arch. Konstantin I.Samoilov, “Europolis”) – the Building 3 (street №25)**



Source: Photo by K.I. Samoilov, 2016

28. The «EUROPOLIS» residential complex, J.Omarova str., Almaty city, Kazakhstan (2006-2014, arch. Konstantin I.Samoilov, “Europolis”) – Buildings 2 and 3 façades (street №№ 21, 25)

THE SIDE FACADE

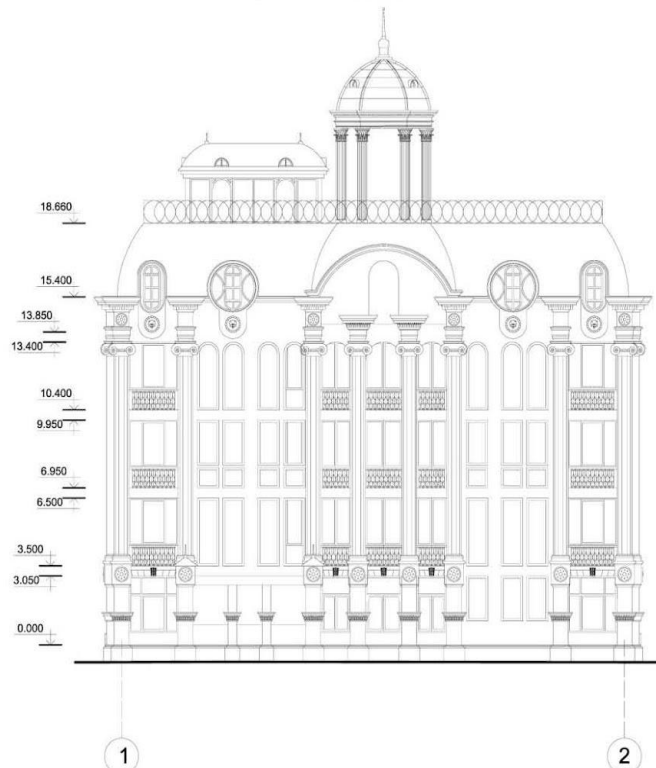

The 4-storey dwelling house (Building №2), Europolis complex, J.Omarova Str., ALMATY
Chief Architect of Project - Konstantin I.Samoilov, 2004

THE SIDE FACADE

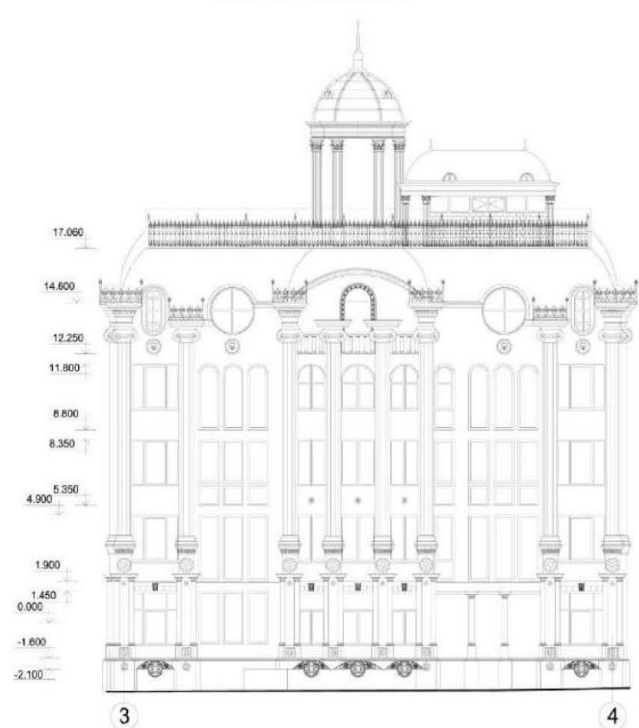

The 4-storey dwelling house (Building №3),
Europolis complex, J.Omarova Str., ALMATY
Chief Architect of Project - Konstantin I.Samoilov, 2005

The «EUROPOLIS» residential complex, Almaty: a fantasy in Palladian style traditions

Ppt-Presentation by Dr. Konstantin I.Samoilov, 2016

29. The «EUROPOLIS» residential complex, J.Omarova str., Almaty city, Kazakhstan (2006-2014, arch. Konstantin I.Samoilov, “Europolis”) – the Stair descent to the Multi-level parking



Source: Photo by K.I.Samoilov, 2016

The «EUROPOLIS» residential complex, Almaty: a fantasy in Palladian style traditions

Ppt-Presentation by Dr. Konstantin I.Samoilov, 2016

**30. The «EUROPOLIS» residential complex, J.Omarova str., Almaty city, Kazakhstan
(2006-2014, arch. Konstantin I.Samoilov, “Europolis”) – the Building 5 (street №29)**



Source: Photo by K.I.Samoilov, 2015

31. The «EUROPOLIS» residential complex, J.Omarova str., Almaty city, Kazakhstan
(2006-2014, arch. Konstantin I.Samoilov, “Europolis”) – the Building 5 floor plan (street №29)

THE FIRST FLOOR LAYOUT

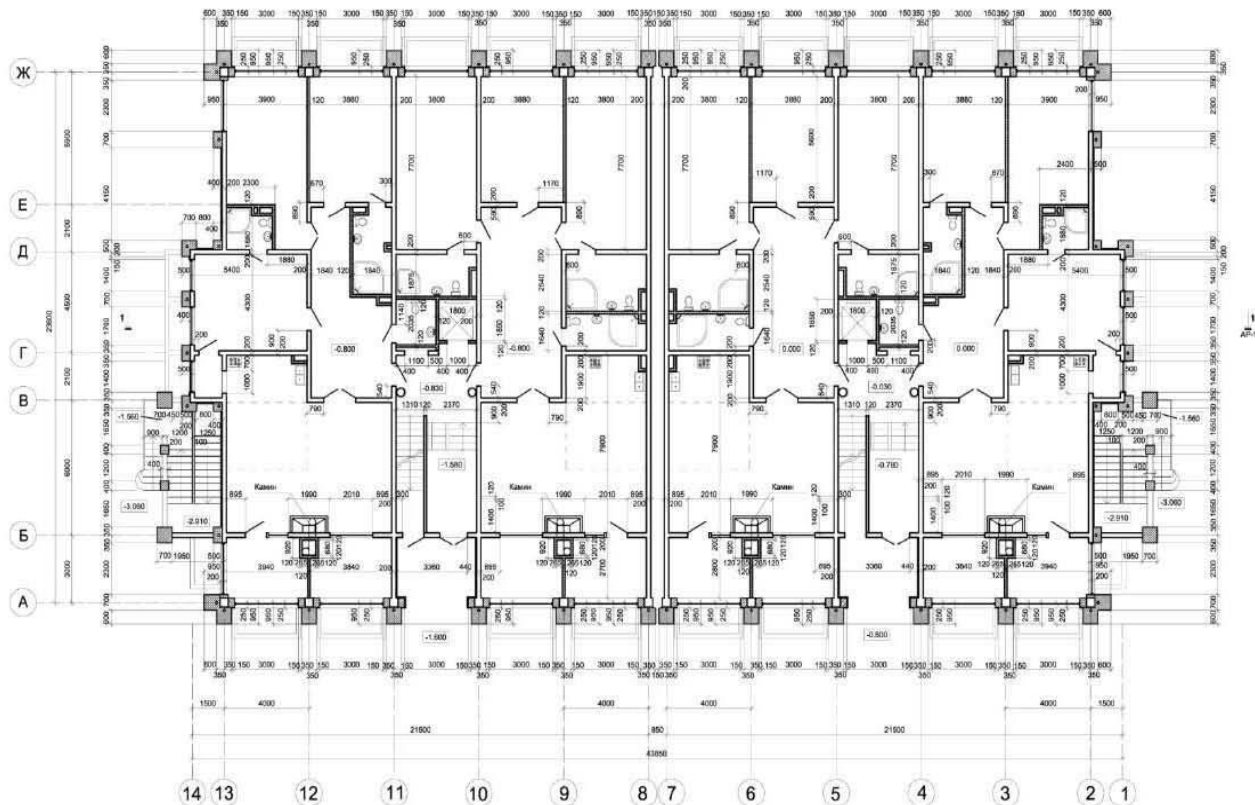

The 4-storey dwelling house (Building №5), Europolis complex, J.Omarova Str., ALMATY

Chief Architect of Project - Konstantin I.Samoilov, 2005

Source: the Project sketch, 2005

The «EUROPOLIS» residential complex, Almaty: a fantasy in Palladian style traditions

Ppt-Presentation by Dr. Konstantin I.Samoilov, 2016

**32. The «EUROPOLIS» residential complex, J.Omarova str., Almaty city, Kazakhstan
(2006-2014, arch. Konstantin I.Samoilov, “Europolis”) – the Building 5 (street №29)**

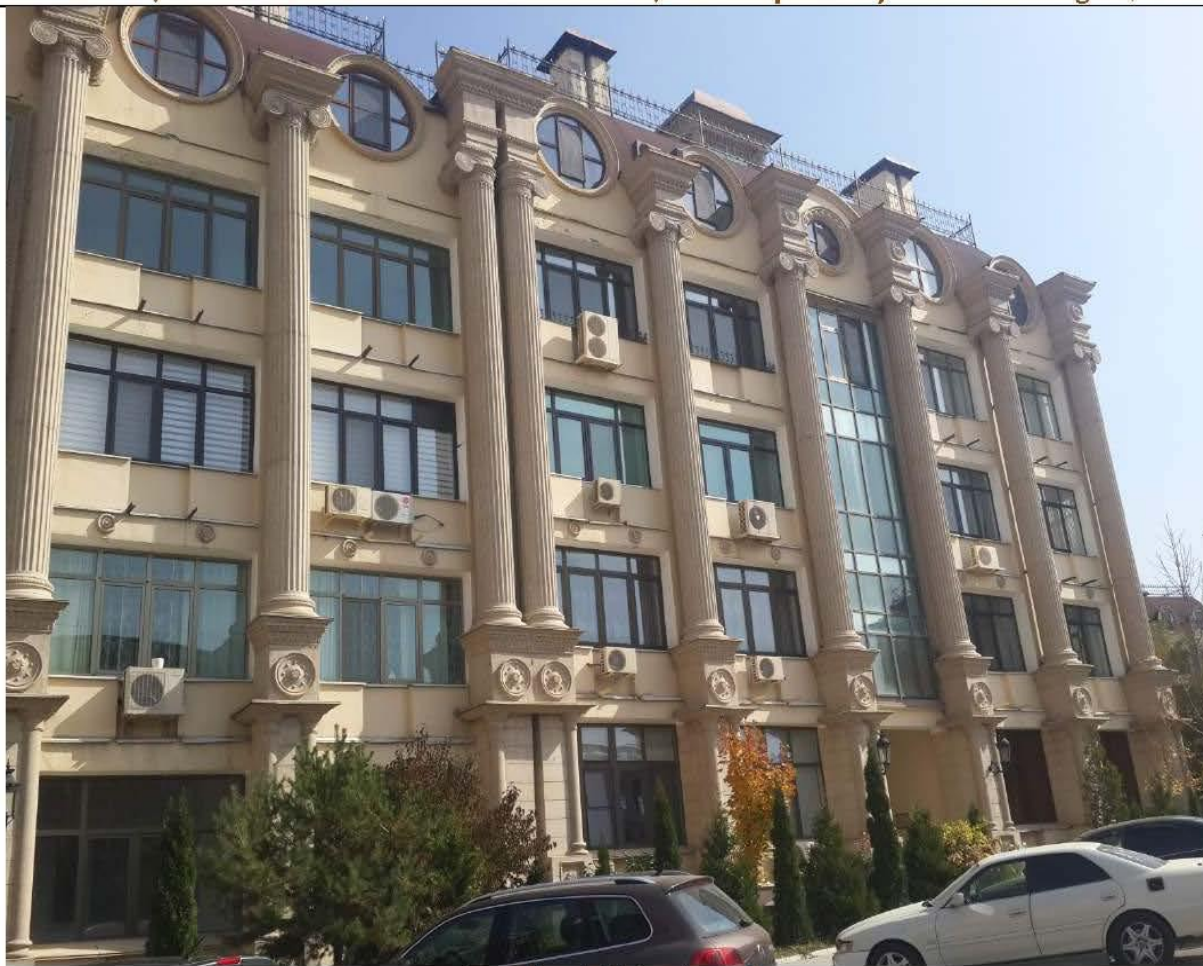

Source: Photo by K.I. Samoilov, 2015

33. The «EUROPOLIS» residential complex, J.Omarova str., Almaty city, Kazakhstan (2006-2014, arch. Konstantin I.Samoilov, “Europolis”) – the Building 5 section view (street №29)

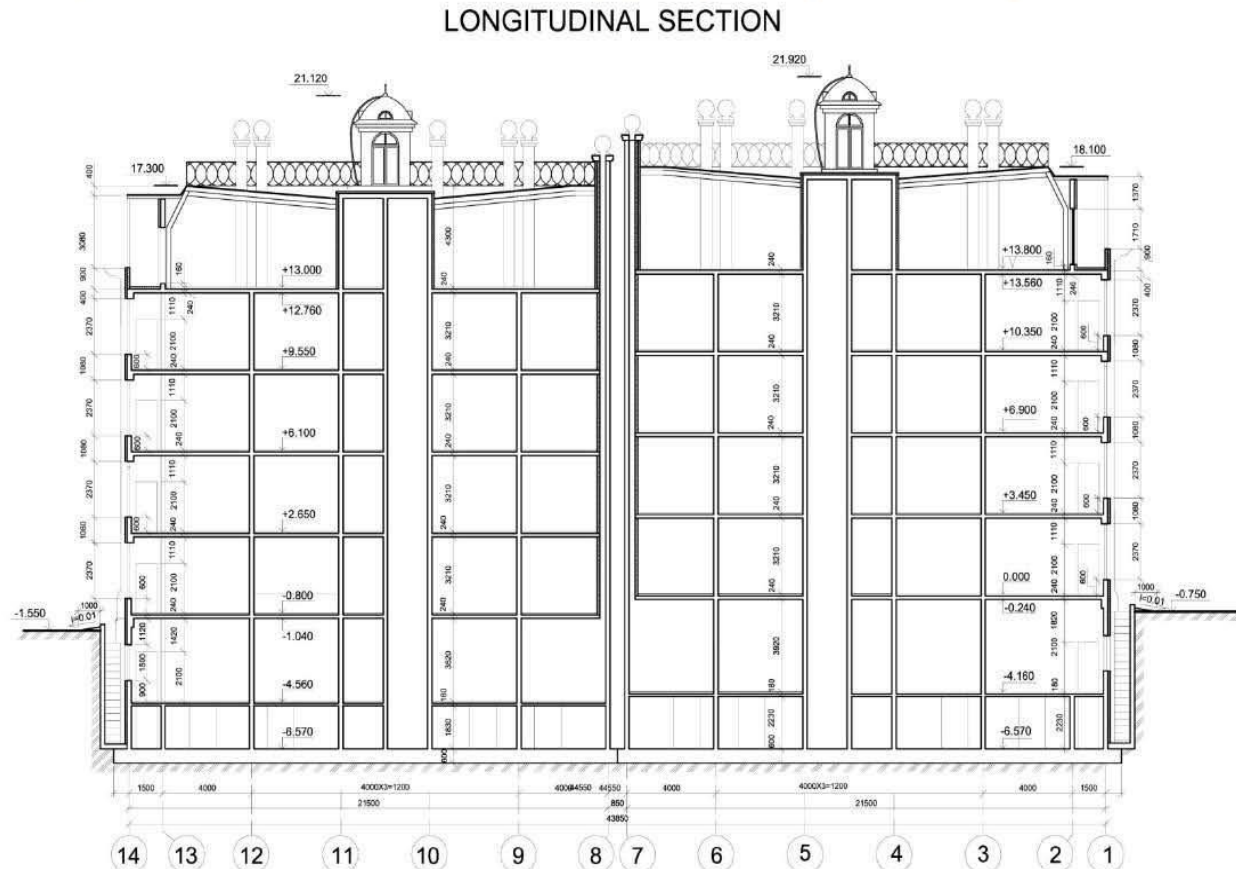

The 4-storey dwelling house (Building №5), Europolis complex, J.Omarova Str., ALMATY
Chief Architect of Project - Konstantin I.Samoilov, 2005

Source: the Project sketch, 2005

The «EUROPOLIS» residential complex, Almaty: a fantasy in Palladian style traditions

Ppt-Presentation by Dr. Konstantin I.Samoilov, 2016

**34. The «EUROPOLIS» residential complex, J.Omarova str., Almaty city, Kazakhstan
(2006-2014, arch. Konstantin I.Samoilov, “Europolis”) – the Building 4 (street №27)**



Source: Photo by K.I.Samoilov, 2016

**35. The «EUROPOLIS» residential complex, J.Omarova str., Almaty city, Kazakhstan
(2006-2014, arch. Konstantin I.Samoilov, “Europolis”) – the Building 5 façade (street №29)**

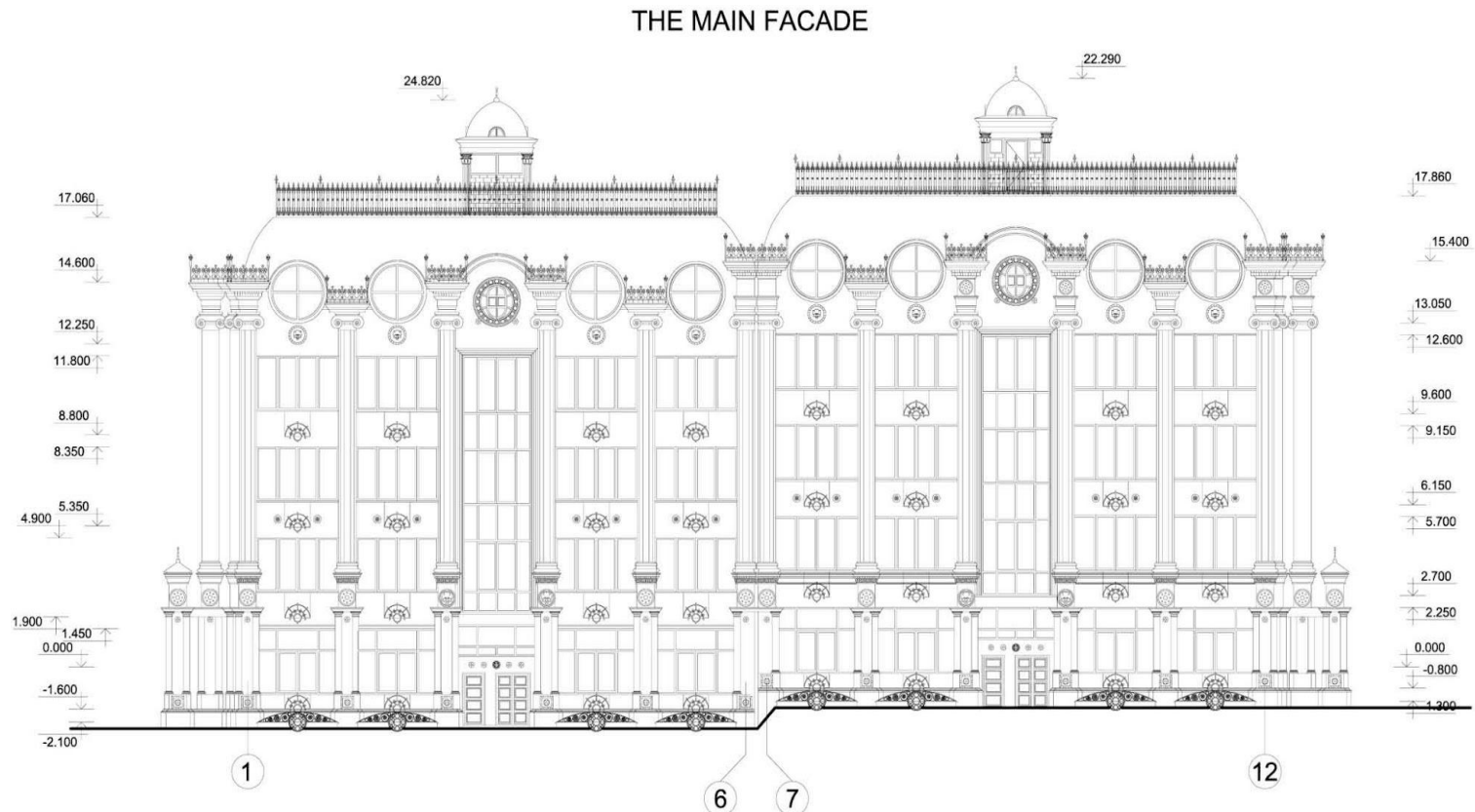

The 4-storey dwelling house (Building №5), Europolis complex, J.Omarova Str., ALMATY
Chief Architect of Project - Konstantin I.Samoilov, 2005

36. The «EUROPOLIS» residential complex, J.Omarova str., Almaty city, Kazakhstan (2006-2014, arch. Konstantin I.Samoilov, “Europolis”) – twin columns with One-volut capitals (the Building 3)

THE MAIN FACADE (fragment)

The joint of building blocks - twin columns with one-volut Ionic caps

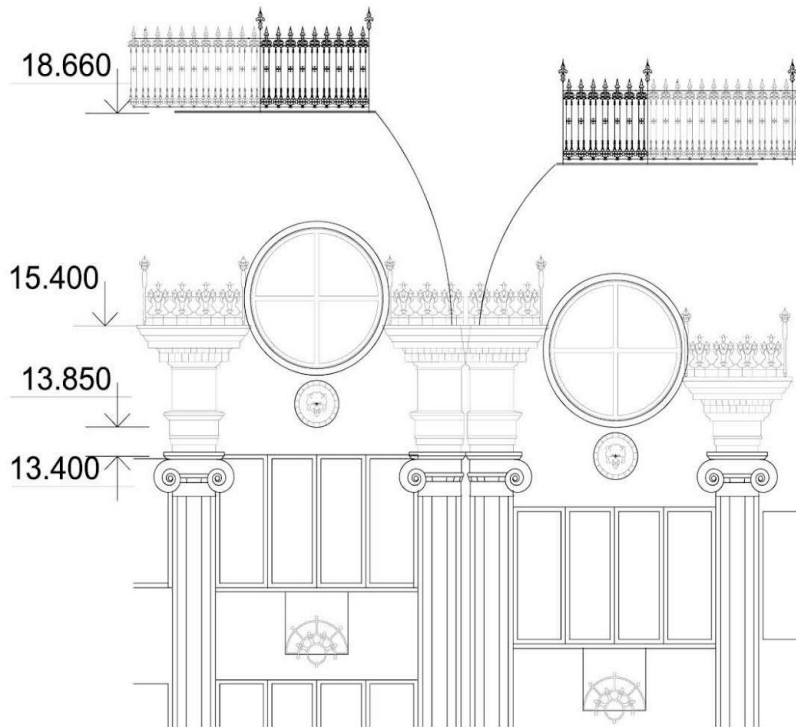

The 4-storey dwelling house (Building №3),
Europolis complex, J.Omarova Str., ALMATY
Chief Architect of Project - Konstantin I.Samoilov, 2005



37. The «EUROPOLIS» residential complex, J.Omarova str., Almaty city, Kazakhstan (2006-2014, arch. Konstantin I.Samoilov, “Europolis”) – the One-volute ionic capital (Buildings 1, 2, 3, 4, 5)

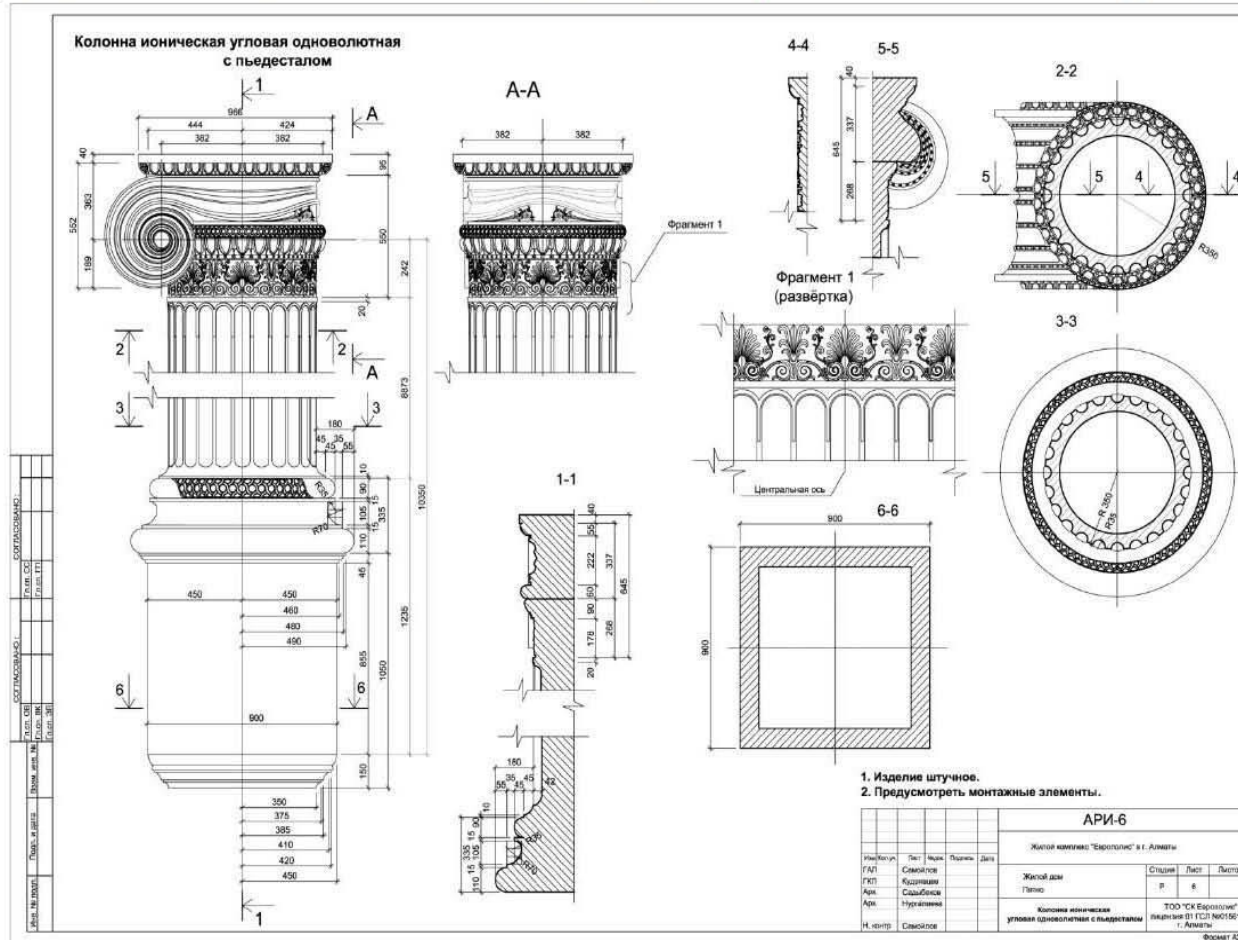

The «EUROPOLIS» residential complex, Almaty: a fantasy in Palladian style traditions

Ppt-Presentation by Dr. Konstantin I.Samoilov, 2016

38. The «EUROPOLIS» residential complex, J.Omarova str., Almaty city, Kazakhstan
(2006-2014, arch. Konstantin I.Samoilov, “Europolis”) – the Building 1 (street №23)

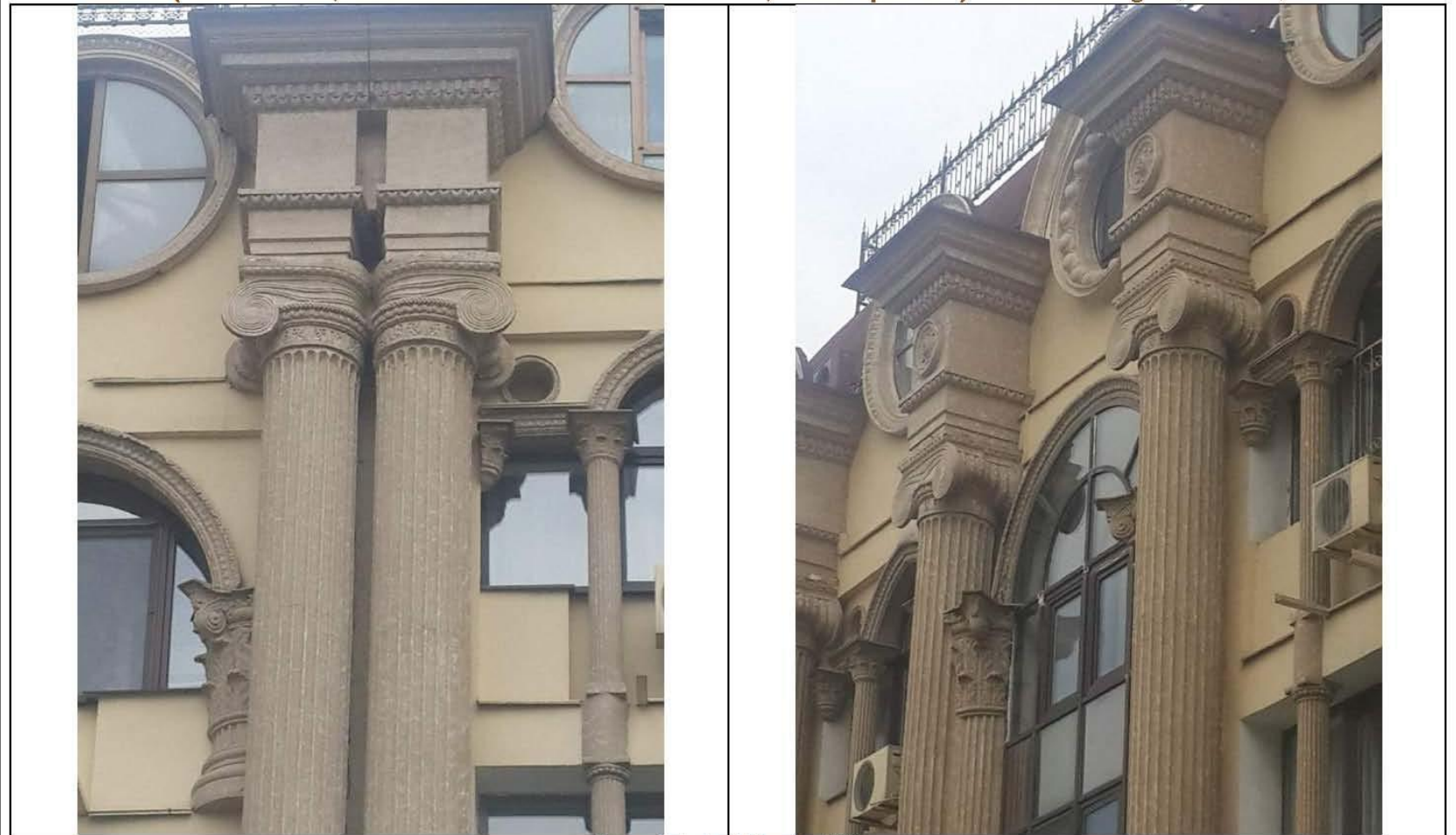

Source: Photos by K.I.Samoilov, 2016

39. The «EUROPOLIS» residential complex, J.Omarova str., Almaty city, Kazakhstan (2006-2014, arch. Konstantin I.Samoilov, “Europolis”) – the Unicorn Angular ionic capital (Buildings 1, 2, 3, 4, 5)

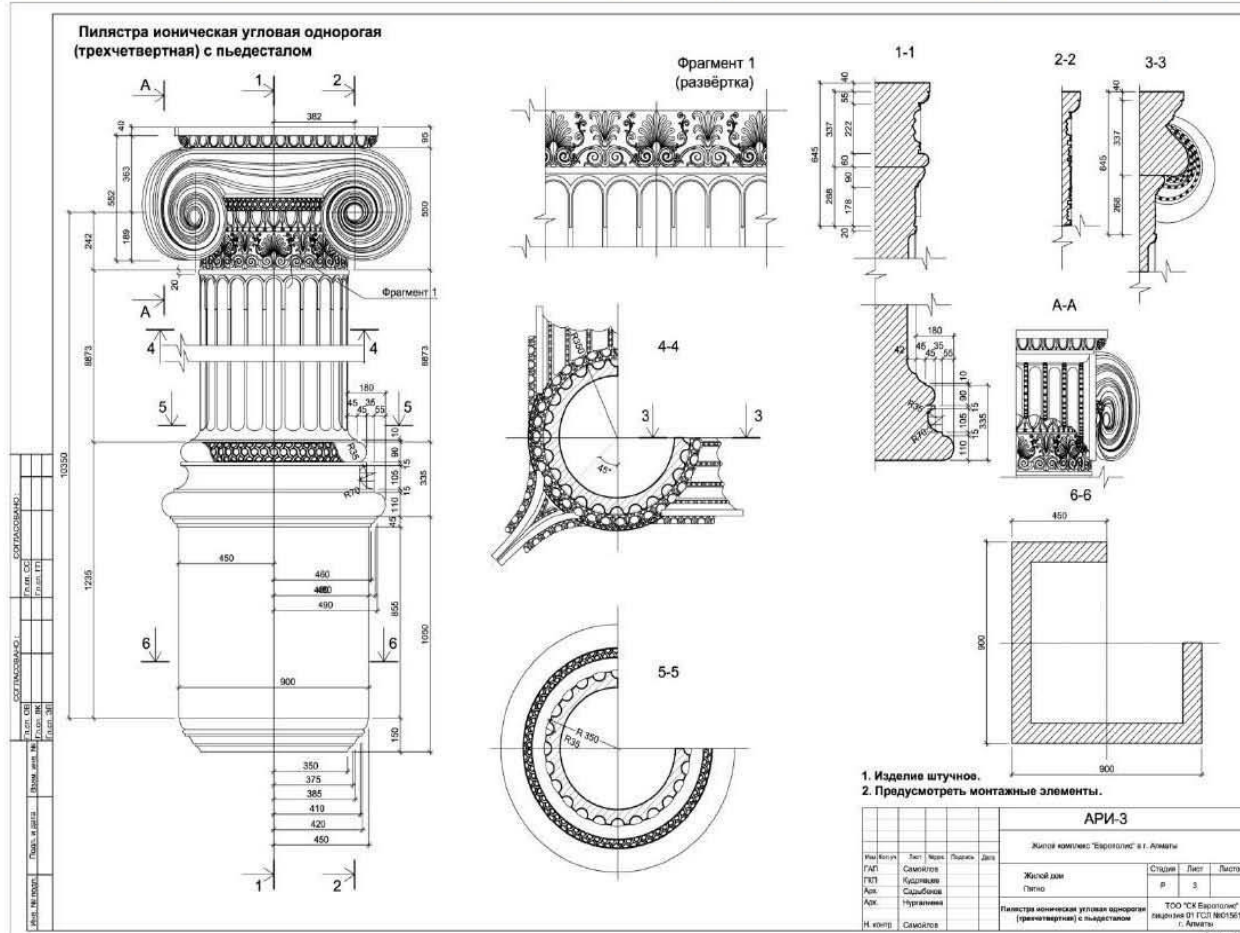

The «EUROPOLIS» residential complex, Almaty: a fantasy in Palladian style traditions

Ppt-Presentation by Dr. Konstantin I. Samoilov, 2016

40. The «EUROPOLIS» residential complex, J.Omarova str., Almaty city, Kazakhstan (2006-2014, arch. Konstantin I.Samoilov, “Europolis”) – the Unicorn Angular ionic capital (the Building 3)



Source: Photo by K.I. Samoilov, 2015

The «EUROPOLIS» residential complex, Almaty: a fantasy in Palladian style traditions

Ppt-Presentation by Dr. Konstantin I.Samoilov, 2016

**41. The «EUROPOLIS» residential complex, J.Omarova str., Almaty city, Kazakhstan
(2006-2014, arch. Konstantin I.Samoilov, “Europolis”) – the Twin Angular ionic capital (the Building 3)**



Source: Photo by K.I. Samoilov, 2015

The «EUROPOLIS» residential complex, Almaty: a fantasy in Palladian style traditions

Ppt-Presentation by Dr. Konstantin I.Samoilov, 2016

**42. The «EUROPOLIS» residential complex, J.Omarova str., Almaty city, Kazakhstan
(2006-2014, arch. Konstantin I.Samoilov, «Europolis») – Gardening and landscaping (Buildings 1, 2)**



Source: Photos by K.I.Samoilov, 2016

The «EUROPOLIS» residential complex, Almaty: a fantasy in Palladian style traditions

Ppt-Presentation by Dr. Konstantin I.Samoilov, 2016

**43. The «EUROPOLIS» residential complex, J.Omarova str., Almaty city, Kazakhstan
(2006-2014, arch. Konstantin I.Samoilov, «Europolis») – Gardening and landscaping (the Building 3)**

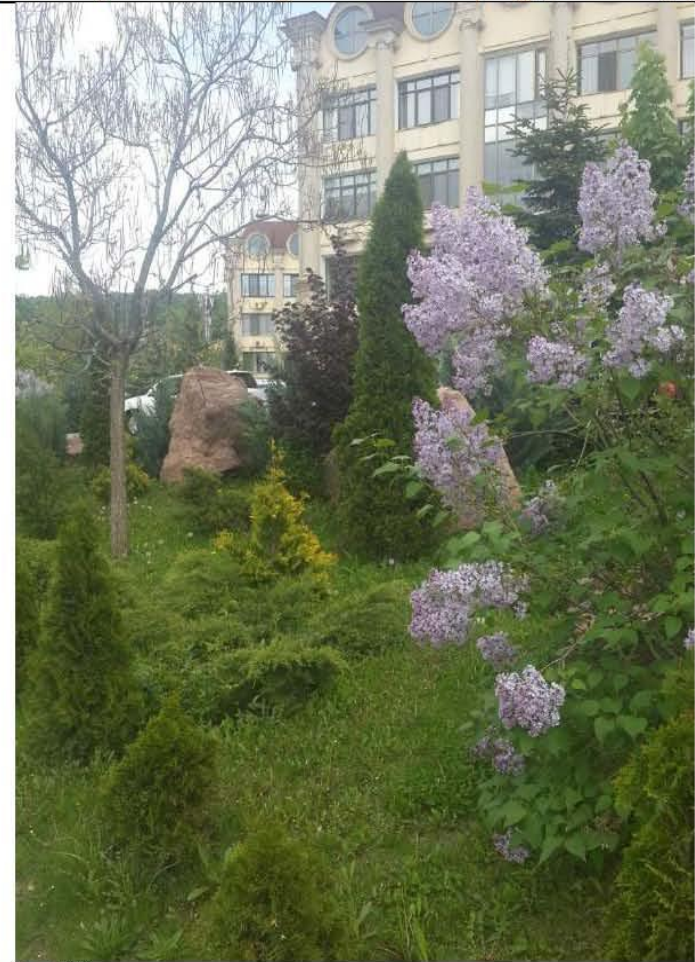

Source: Photos by K.I.Samoilov, 2016

The «EUROPOLIS» residential complex, Almaty: a fantasy in Palladian style traditions

Ppt-Presentation by Dr. Konstantin I.Samoilov, 2016

**44. The «EUROPOLIS» residential complex, J.Omarova str., Almaty city, Kazakhstan
(2006-2014, arch. Konstantin I.Samoilov, «Europolis») – Gardening and landscaping (Buildings 2, 3)**

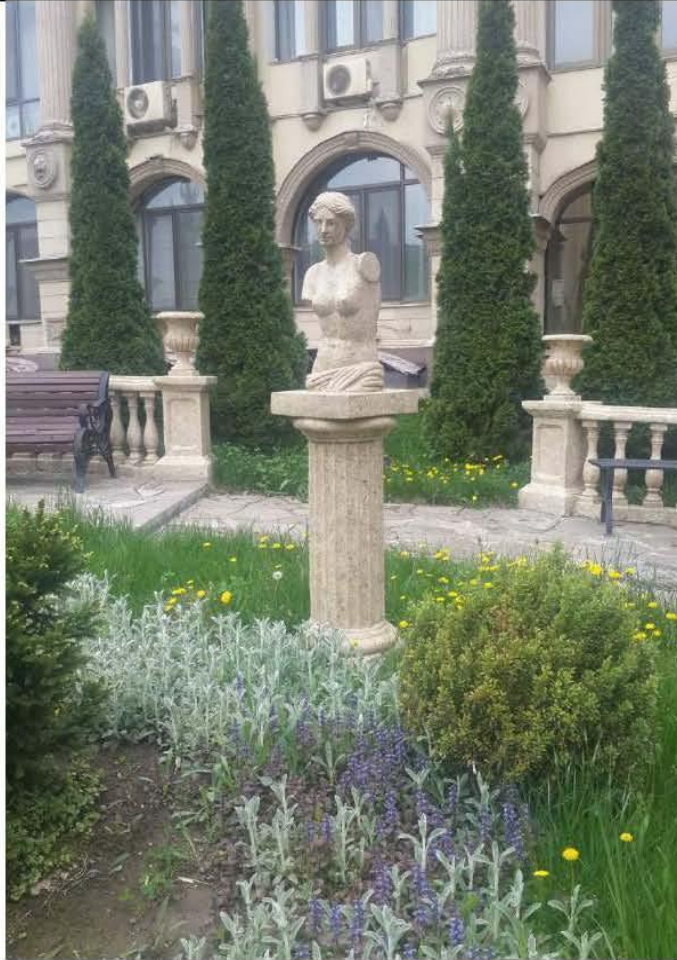

Source: Photos by K.I.Samoilov, 2016

The «EUROPOLIS» residential complex, Almaty: a fantasy in Palladian style traditions

Ppt-Presentation by Dr. Konstantin I.Samoilov, 2016

**45. The «EUROPOLIS» residential complex, J.Omarova str., Almaty city, Kazakhstan
(2006-2014, arch. Konstantin I.Samoilov, «Europolis») – Gardening and landscaping (the Building 3)**



Source: Photos by K.I.Samoilov, 2016

The «EUROPOLIS» residential complex, Almaty: a fantasy in Palladian style traditions

Ppt-Presentation by Dr. Konstantin I.Samoilov, 2016

**46. The «EUROPOLIS» residential complex, J.Omarova str., Almaty city, Kazakhstan
(2006-2014, arch. Konstantin I.Samoilov, «Europolis») – Gardening and landscaping (the Building 5)**



Source: Photos by K.I.Samoilov, 2016

The «EUROPOLIS» residential complex, Almaty: a fantasy in Palladian style traditions

Ppt-Presentation by Dr. Konstantin I.Samoilov, 2016

47. The «EUROPOLIS» residential complex, J.Omarova str., Almaty city, Kazakhstan (2006-2014, arch. Konstantin I.Samoilov, «Europolis») – Gardening and landscaping (Buildings 2, 3)



Source: Photos by K.I.Samoilov, 2016

The «EUROPOLIS» residential complex, Almaty: a fantasy in Palladian style traditions

Ppt-Presentation by Dr. Konstantin I.Samoilov, 2016

**48. The «EUROPOLIS» residential complex, J.Omarova str., Almaty city, Kazakhstan
(2006-2014, arch. Konstantin I.Samoilov, “Europolis”) – Gardening and landscaping (the Building 4)**

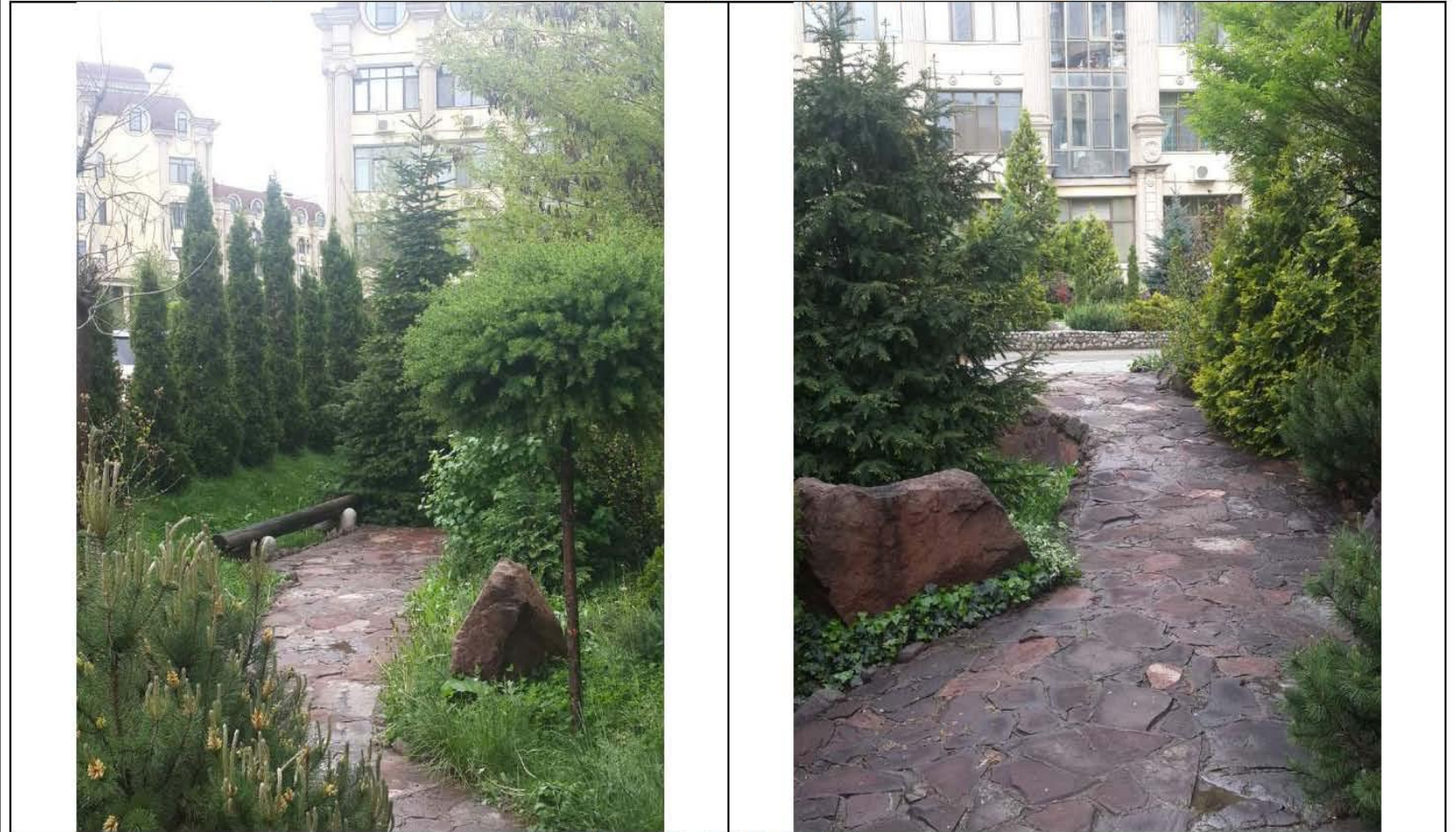

Source: Photos by K.I.Samoilov, 2016

The «EUROPOLIS» residential complex, Almaty: a fantasy in Palladian style traditions

Ppt-Presentation by Dr. Konstantin I.Samoilov, 2016

49. The «EUROPOLIS» residential complex, J.Omarova str., Almaty city, Kazakhstan (2006-2014, arch. Konstantin I.Samoilov, «Europolis») – Gardening and landscaping (Buildings 2, 3)



Source: Photo by K.I.Samoilov, 2016

The «EUROPOLIS» residential complex, Almaty: a fantasy in Palladian style traditions

Ppt-Presentation by Dr. Konstantin I.Samoilov, 2016

50. The «EUROPOLIS» residential complex, J.Omarova str., Almaty city, Kazakhstan (2006-2014, arch. Konstantin I.Samoilov, “Europolis”) – the Façade, the Section view (Buildings 6, 7, 8, 9, 10)

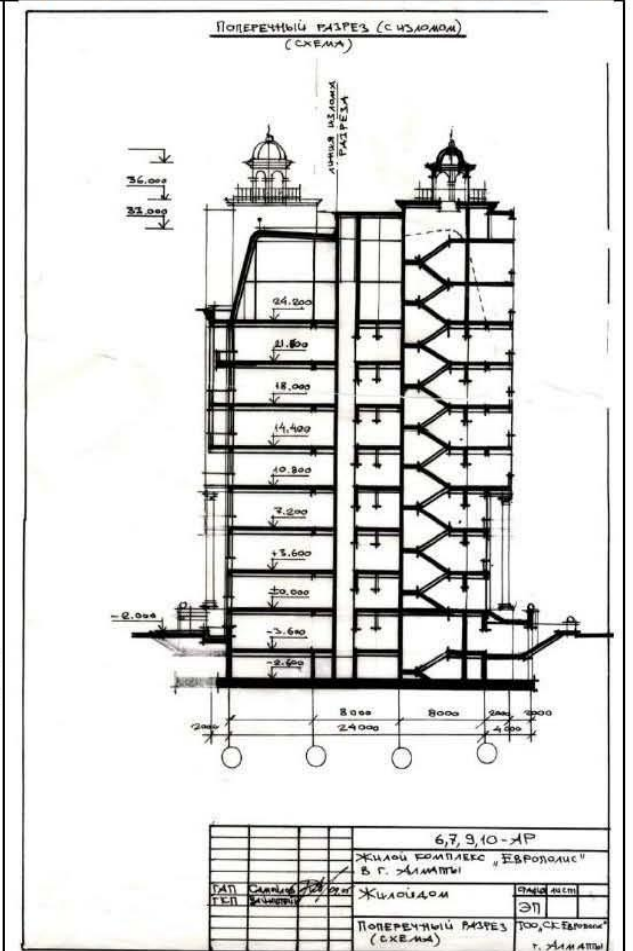
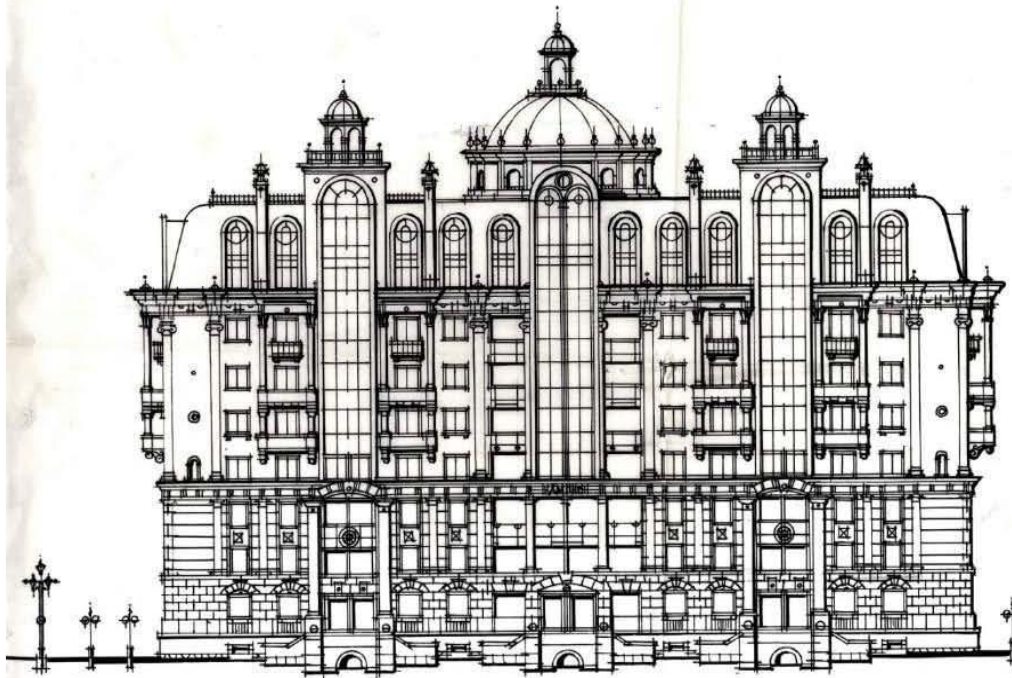

Source: Pre-project Sketches, 2005

The «EUROPOLIS» residential complex, Almaty: a fantasy in Palladian style traditions

Ppt-Presentation by Dr. Konstantin I.Samoilov, 2016

51. The «EUROPOLIS» residential complex, J.Omarova str., Almaty city, Kazakhstan
(2006-2014, arch. Konstantin I.Samoilov, «Europolis») – the Façade fragment (Buildings 6, 7, 8, 9, 10)



Source: the Pre-project Sketch, 2005

The «EUROPOLIS» residential complex, Almaty: a fantasy in Palladian style traditions

Ppt-Presentation by Dr. Konstantin I.Samoilov, 2016

52. The «EUROPOLIS» residential complex, J.Omarova str., Almaty city, Kazakhstan
(2006-2014, arch. Konstantin I.Samoilov, «Europolis») – the typical Floor plan (Buildings 6, 7, 8, 9, 10)

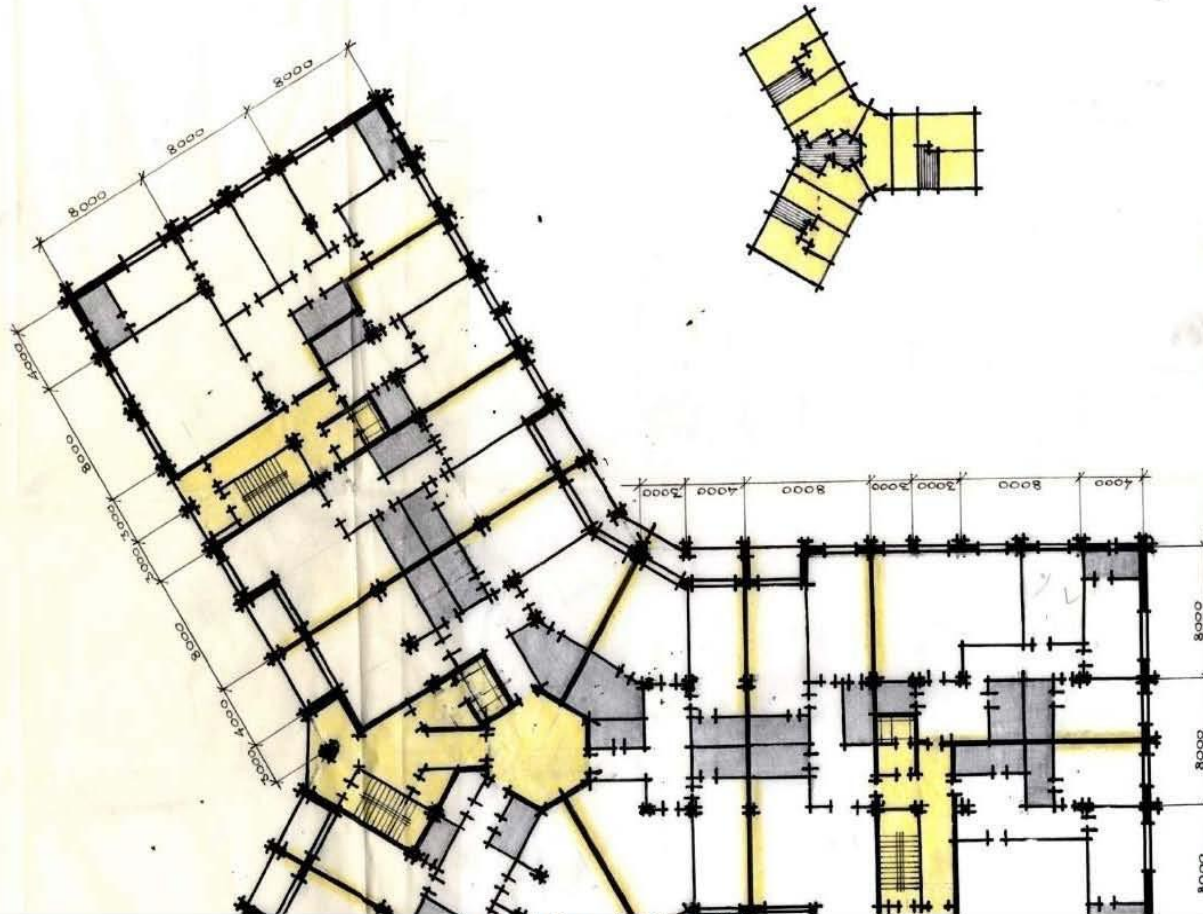

Source: the Pre-project Sketch, 2005

The «EUROPOLIS» residential complex, Almaty: a fantasy in Palladian style traditions

Ppt-Presentation by Dr. Konstantin I.Samoilov, 2016

53. The «EUROPOLIS» residential complex, J.Omarova str., Almaty city, Kazakhstan
(2006-2014, arch. Konstantin I.Samoilov, «Europolis») – Floor plan fragments (Buildings 6, 7, 8, 9, 10)

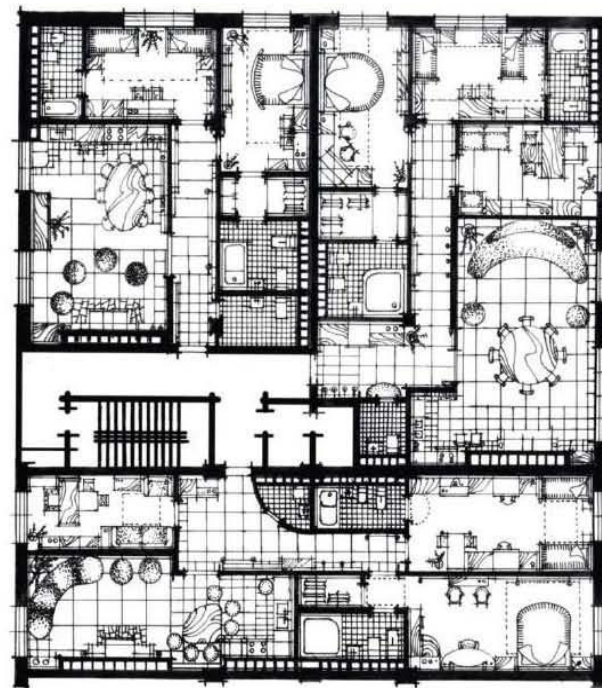
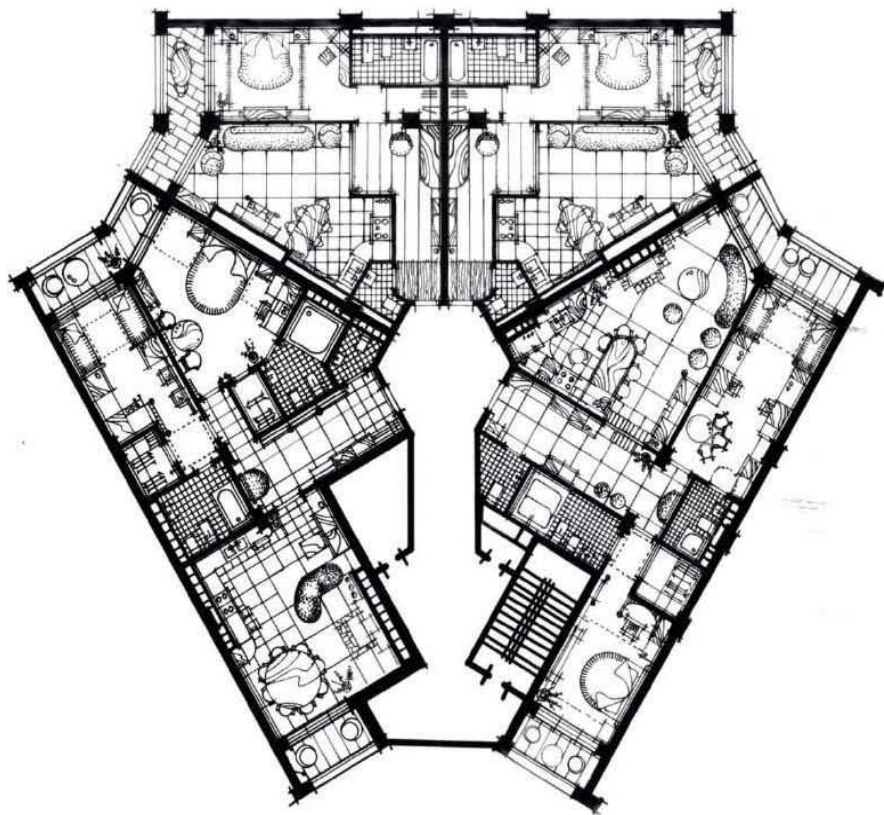

Source: Pre-project Sketches, 2005

The «EUROPOLIS» residential complex, Almaty: a fantasy in Palladian style traditions

Ppt-Presentation by Dr. Konstantin I.Samoilov, 2016

54. The «EUROPOLIS» residential complex, J.Omarova str., Almaty city, Kazakhstan (2006-2014, arch. Konstantin I.Samoilov, «Europolis») – Apartment plans (Buildings 6, 7, 8, 9, 10)

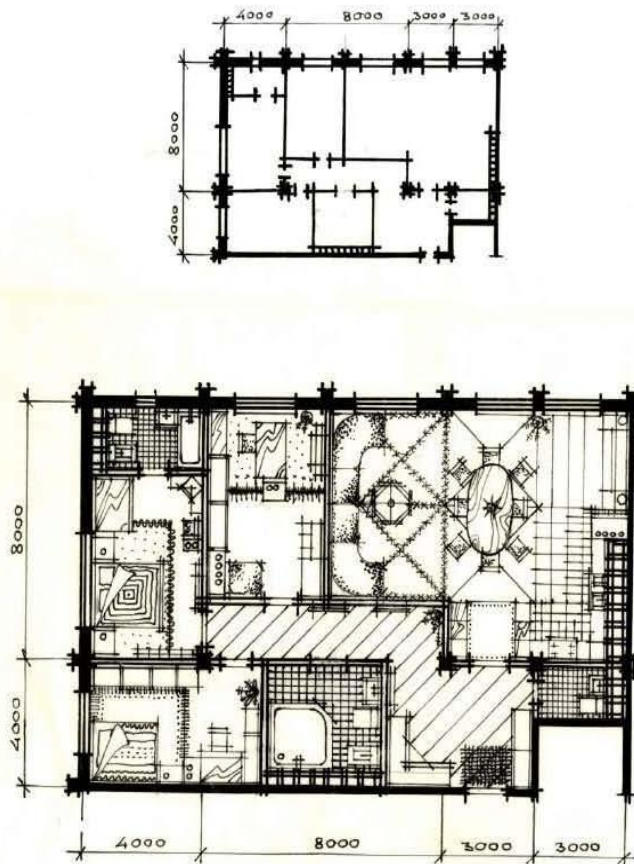

Source: Pre-project Sketches, 2005

The «EUROPOLIS» residential complex, Almaty: a fantasy in Palladian style traditions

Ppt-Presentation by Dr. Konstantin I.Samoilov, 2016

55. The «EUROPOLIS» residential complex, J.Omarova str., Almaty city, Kazakhstan (2006-2014, arch. Konstantin I.Samoilov, «Europolis») – Apartments plans (Buildings 6, 7, 8, 9, 10)

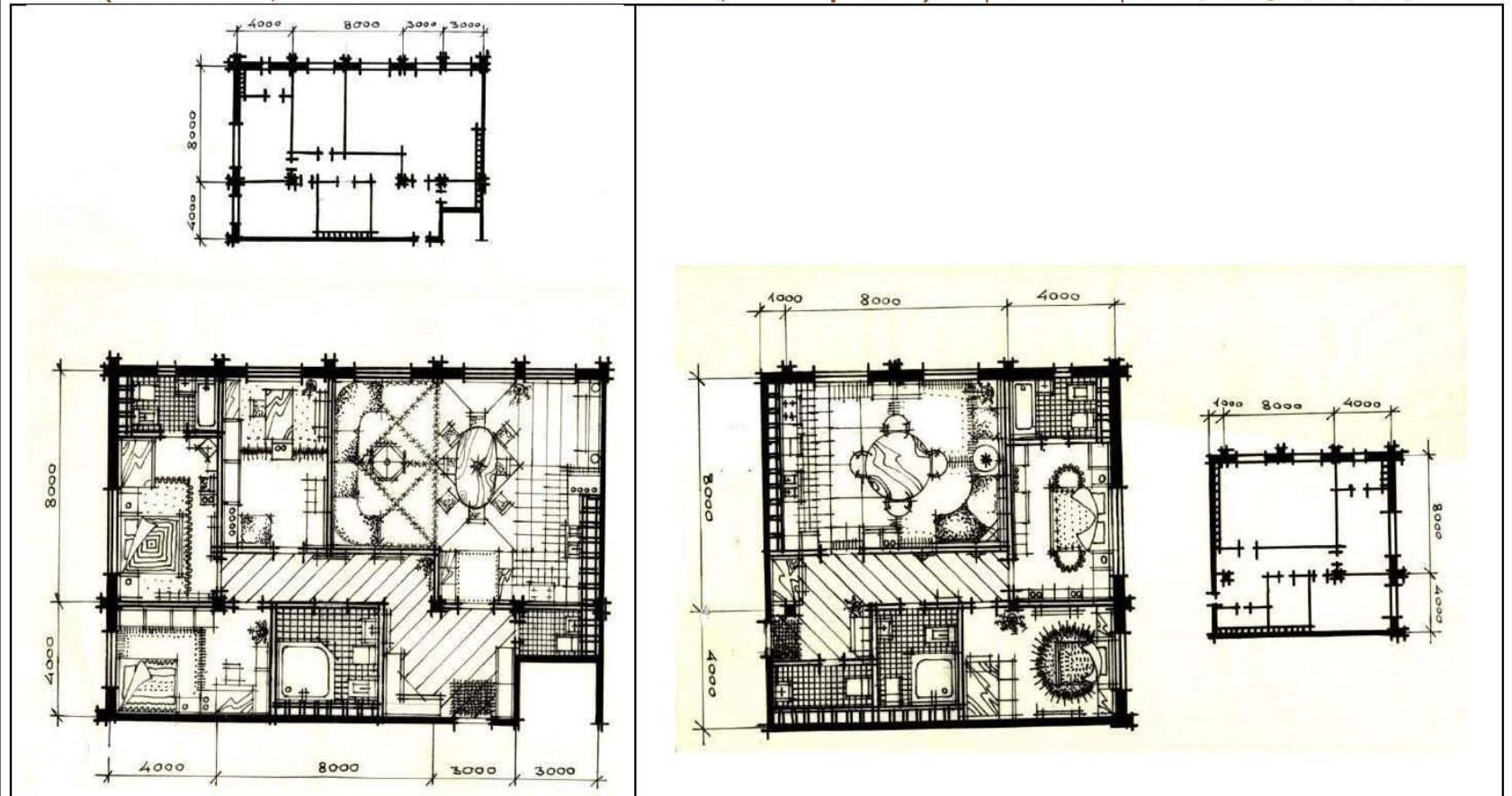

Source: Pre-project Sketches, 2005

The «EUROPOLIS» residential complex, Almaty: a fantasy in Palladian style traditions

Ppt-Presentation by Dr. Konstantin I.Samoilov, 2016

56. The «EUROPOLIS» residential complex, J.Omarova str., Almaty city, Kazakhstan (2006-2014, arch. Konstantin I.Samoilov, «Europolis») – Apartment plans (Buildings 6, 7, 8, 9, 10)

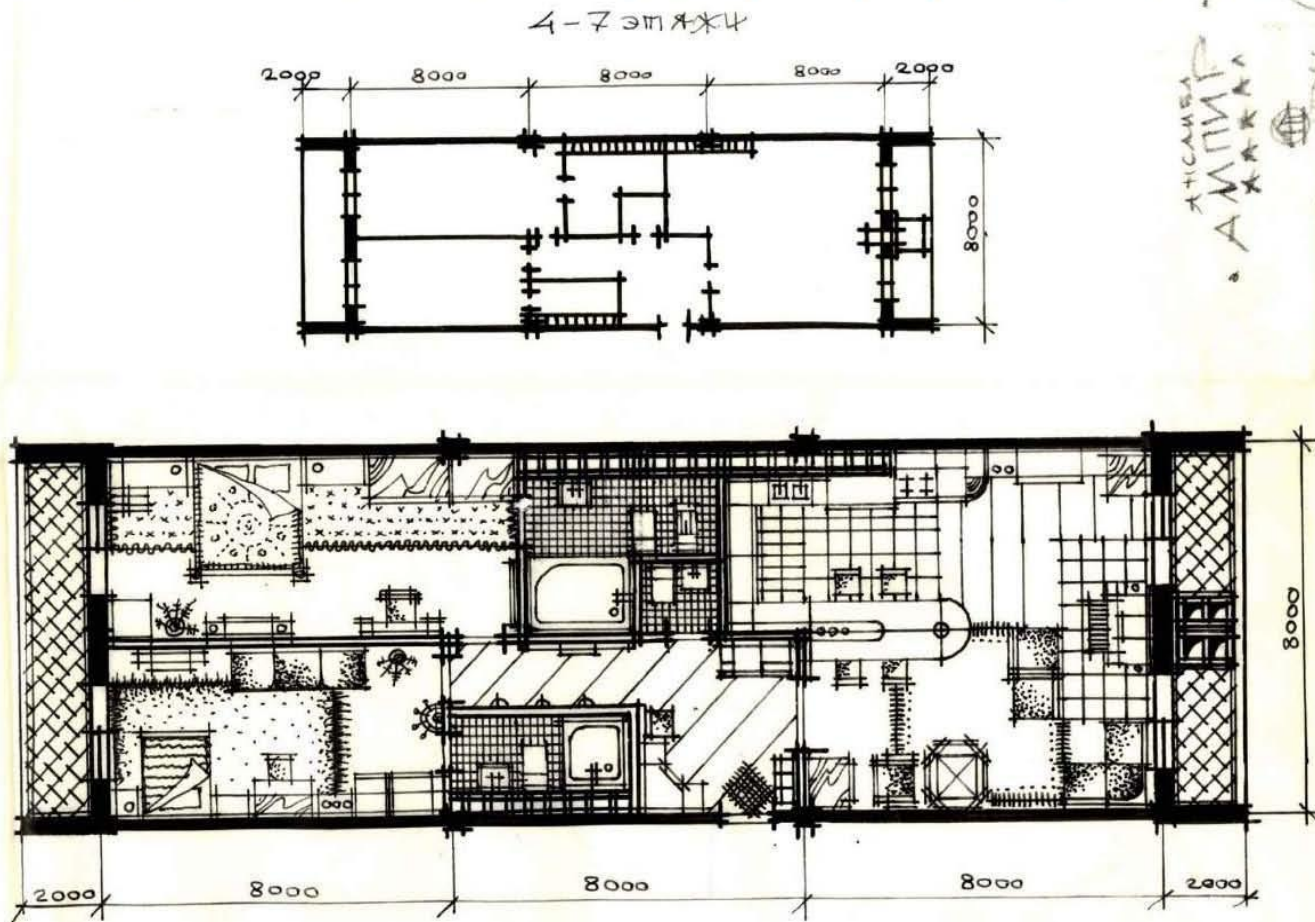

Source: Pre-project Sketches, 2005

The «EUROPOLIS» residential complex, Almaty: a fantasy in Palladian style traditions

Ppt-Presentation by Dr. Konstantin I.Samoilov, 2016

57. The «EUROPOLIS» residential complex, J.Omarova str., Almaty city, Kazakhstan (2006-2014, arch. Konstantin I.Samoilov, “Europolis”) – Apartments plans (Buildings 6, 7, 8, 9, 10)

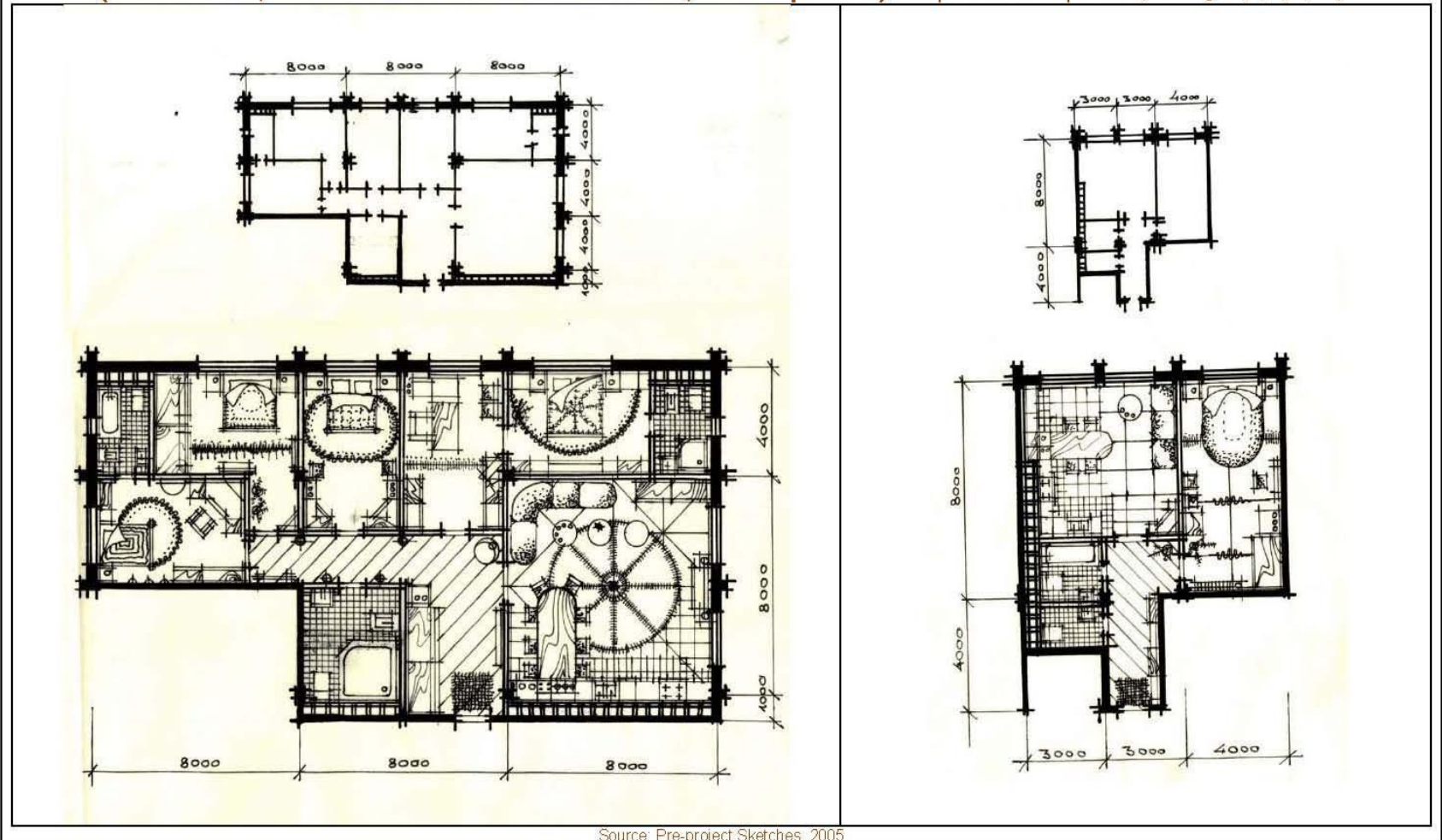

Source: Pre-project Sketches, 2005

The «EUROPOLIS» residential complex, Almaty: a fantasy in Palladian style traditions

Ppt-Presentation by Dr. Konstantin I.Samoilov, 2016

58. The «EUROPOLIS» residential complex, J.Omarova str., Almaty city, Kazakhstan
(2006-2014, arch. Konstantin I.Samoilov, «Europolis») – Apartment plans (Buildings 6, 7, 8, 9, 10)

1-3 этаж

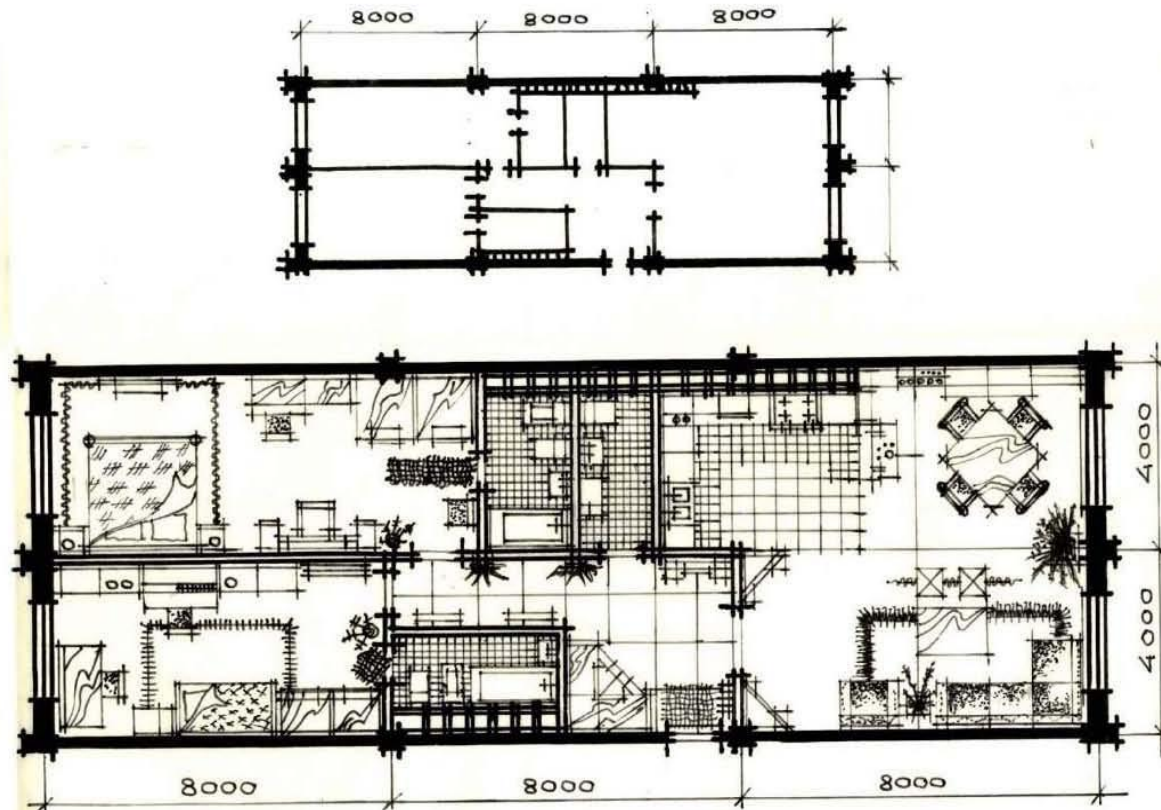

Source: Pre-project Sketches, 2005

59. The «EUROPOLIS» residential complex, J.Omarova str., Almaty city, Kazakhstan
(2006-2014, arch. Konstantin I.Samoilov, «Europolis») – Apartment plans (Buildings 6, 7, 8, 9, 10)

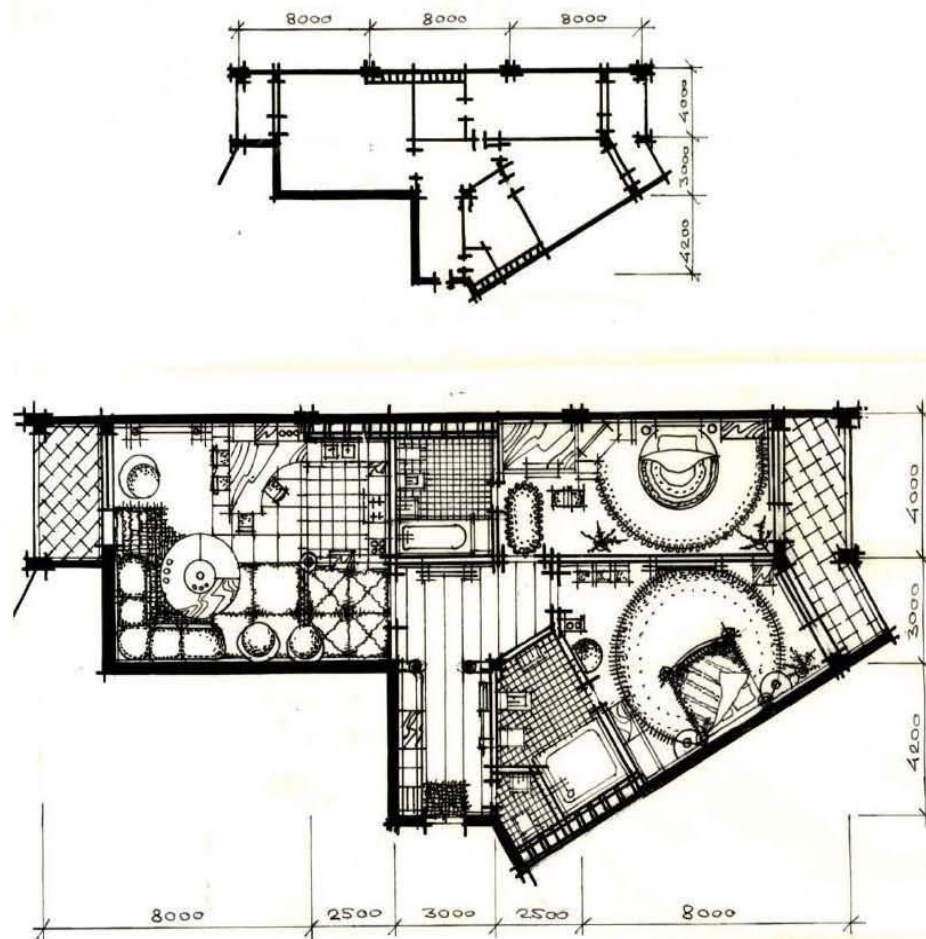

The «EUROPOLIS» residential complex, Almaty: a fantasy in Palladian style traditions

Ppt-Presentation by Dr. Konstantin I.Samoilov, 2016

60. The «EUROPOLIS» residential complex, J.Omarova str., Almaty city, Kazakhstan
(2006-2014, arch. Konstantin I.Samoilov, «Europolis») – Apartment plans (Buildings 6, 7, 8, 9, 10)

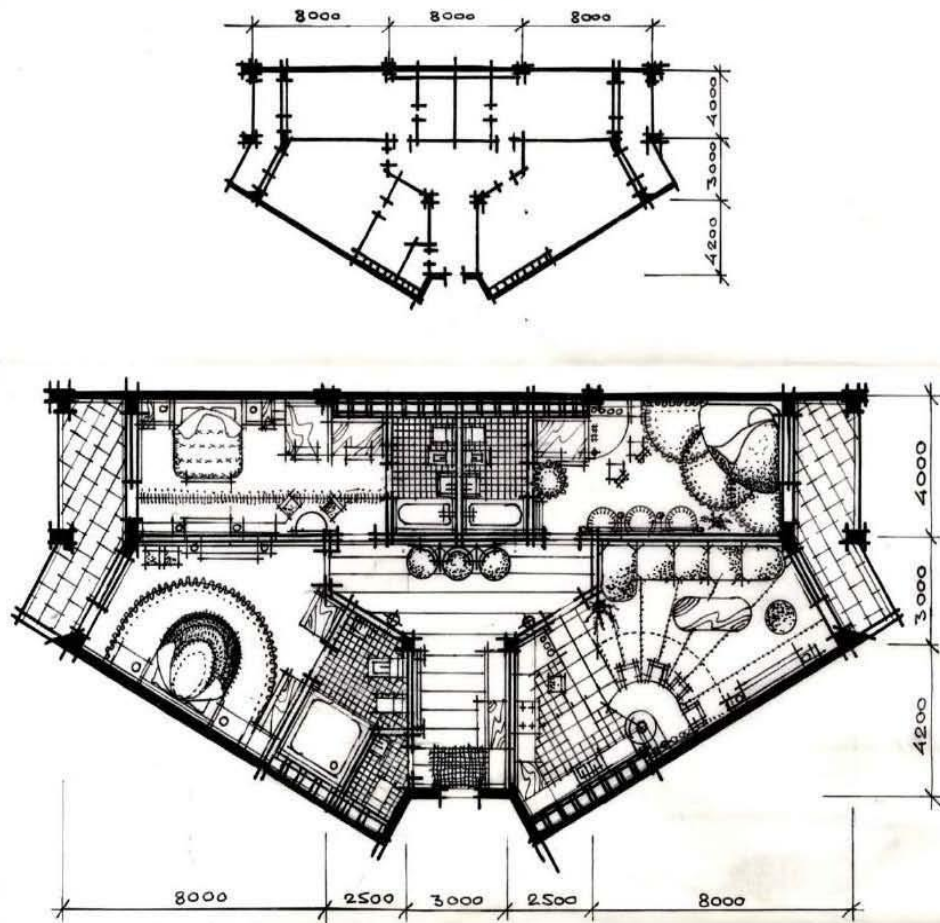

Source: Pre-project Sketches, 2005

The «EUROPOLIS» residential complex, Almaty: a fantasy in Palladian style traditions

Ppt-Presentation by Dr. Konstantin I.Samoilov, 2016

61. The «EUROPOLIS» residential complex, J.Omarova str., Almaty city, Kazakhstan (2006-2014, arch. Konstantin I.Samoilov, «Europolis») – Apartment plans (Buildings 6, 7, 8, 9, 10)

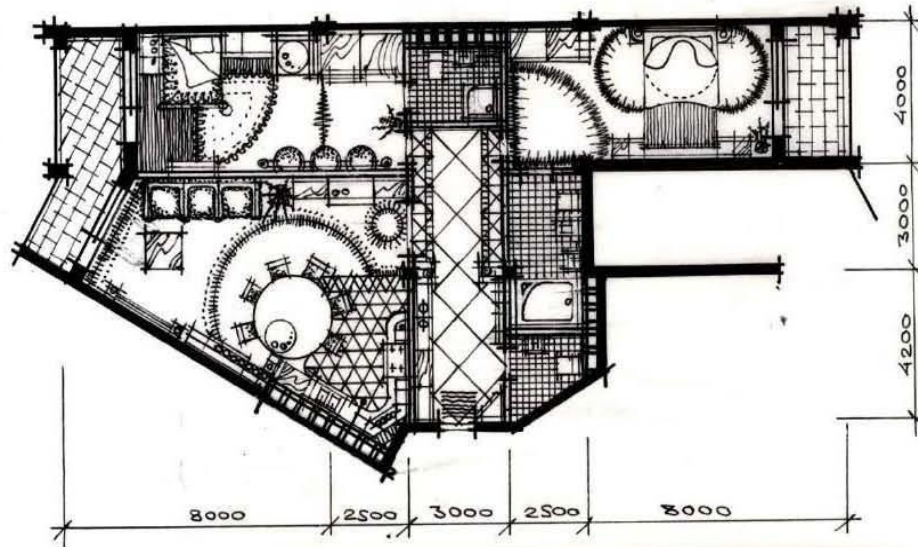
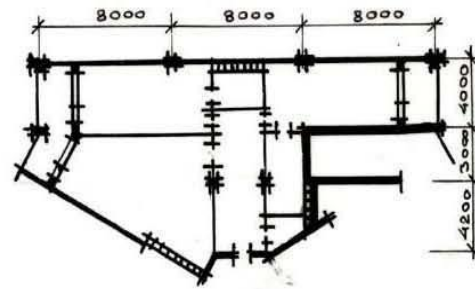

Source: Pre-project Sketches, 2005

The «EUROPOLIS» residential complex, Almaty: a fantasy in Palladian style traditions

Ppt-Presentation by Dr. Konstantin I.Samoilov, 2016

62. The «EUROPOLIS» residential complex, J.Omarova str., Almaty city, Kazakhstan (2006-2014, arch. Konstantin I.Samoilov, “Europolis”) – the Building main image (Buildings 6, 7, 8, 9, 10)

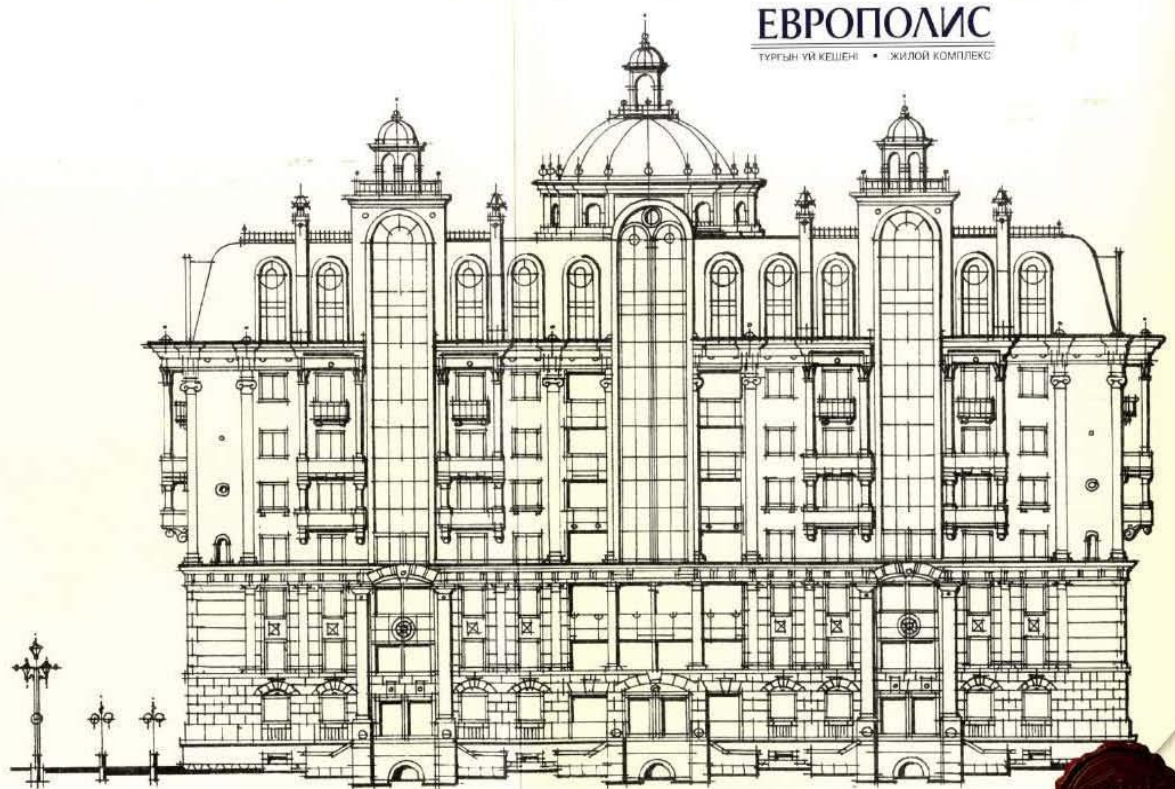

ЕВРОПОЛИС
ТУРГЫН ҮЙ КЕШЕНІ • ЖИЛЫЙ КОМПЛЕКС

ИМПЕРИУМ
ПЛАЦ



Казakhstan, 050100, г. Алматы
ул. Бөгенбай батыра, 117
e-mail: info@europolis.kz
site: www.europolis.kz

Телефоны отдела продаж:
32 72 / 726 - 999, 727 - 999, 728 - 999, 724 - 999
8-300 / 555-0069, 555-0089, 555-0096, 555-7081
8-333 / 260-1111, 260-2222, 261-2222, 262-0000

Source: the Cover of the Advertising brochure, 2005

The «EUROPOLIS» residential complex, Almaty: a fantasy in Palladian style traditions

Ppt-Presentation by Dr. Konstantin I.Samoilov, 2016

63. The «EUROPOLIS» residential complex, J.Omarova str., Almaty city, Kazakhstan
(2006-2014, arch. Konstantin I.Samoilov, «Europolis») – Main panoramic views (Buildings 6, 7, 8, 9, 10)

*Жилой дом
Империя*



*Панорама
комплекса*

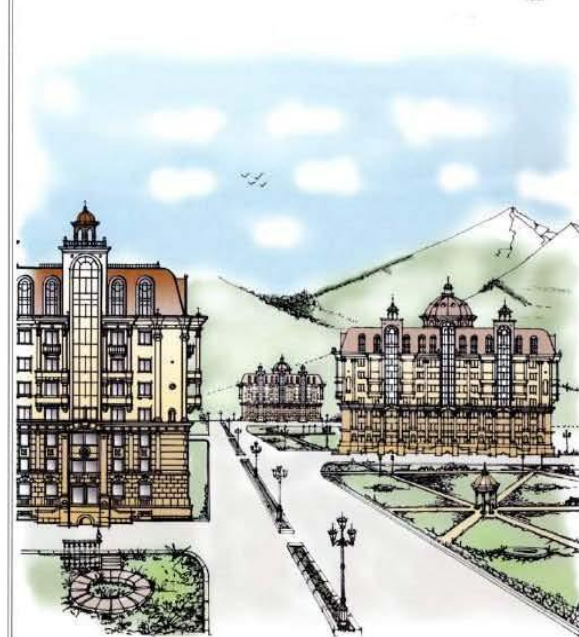

Source: Sketches from the Advertising brochure, 2005

The «EUROPOLIS» residential complex, Almaty: a fantasy in Palladian style traditions

Ppt-Presentation by Dr. Konstantin I.Samoilov, 2016

**64. The «EUROPOLIS» residential complex, J.Omarova str., Almaty city, Kazakhstan
(2006-2014, arch. Konstantin I.Samoilov, “Europolis”) – the Main street (Southern and Northern views)**



Source: Photos by K.I.Samoilov, 2016

The «EUROPOLIS» residential complex, Almaty: a fantasy in Palladian style traditions

Ppt-Presentation by Dr. Konstantin I.Samoilov, 2016

**65. The «EUROPOLIS» residential complex, J.Omarova str., Almaty city, Kazakhstan
(2006-2014, arch. Konstantin I.Samoilov, “Europolis”) – Buildings 7 and 5 (street №№ 33, 29)**



Source: Photo by K.I. Samoilov, 2016

The «EUROPOLIS» residential complex, Almaty: a fantasy in Palladian style traditions

Ppt-Presentation by Dr. Konstantin I.Samoilov, 2016

66. The «EUROPOLIS» residential complex, J.Omarova str., Almaty city, Kazakhstan
(2006-2014, arch. Konstantin I.Samoilov, “Europolis”) – Buildings 6, 7, 8, 9, 10 façades



Source: Project sketches, 2005

The «EUROPOLIS» residential complex, Almaty: a fantasy in Palladian style traditions

Ppt-Presentation by Dr. Konstantin I.Samoilov, 2016

67. The «EUROPOLIS» residential complex, J.Omarova str., Almaty city, Kazakhstan (2006-2014, arch. Konstantin I.Samoilov, “Europolis”) – the Building 7 panoramic view



Source: Presentation materials, 2005

The «EUROPOLIS» residential complex, Almaty: a fantasy in Palladian style traditions

Ppt-Presentation by Dr. Konstantin I.Samoilov, 2016

68. The «EUROPOLIS» residential complex, J.Omarova str., Almaty city, Kazakhstan
(2006-2014, arch. Konstantin I.Samoilov, “Europolis”) – the Building 7 model (street № 33)



Source: Presentation materials (the Model – 1:100), 2015

The «EUROPOLIS» residential complex, Almaty: a fantasy in Palladian style traditions

Ppt-Presentation by Dr. Konstantin I.Samoilov, 2016

69. The «EUROPOLIS» residential complex, J.Omarova str., Almaty city, Kazakhstan
(2006-2014, arch. Konstantin I.Samoilov, “Europolis”) – the Building 7 façade (street № 33)

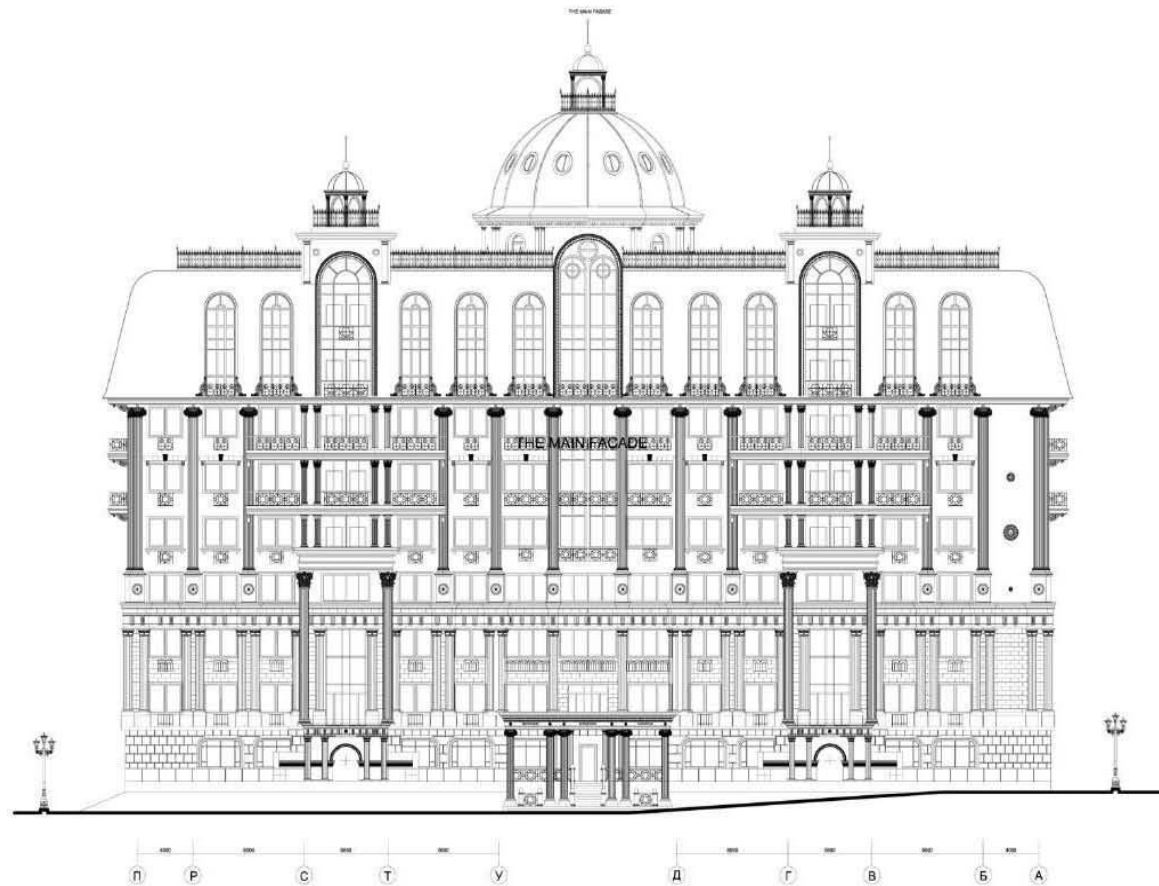

The 6-storey dwelling house (Building №7), Europolis complex, J.Omarova Str., ALMATY
Chief Architect of Project - Konstantin I.Samoilov, 2007

Source: the Project sketch, 2007

The «EUROPOLIS» residential complex, Almaty: a fantasy in Palladian style traditions

Ppt-Presentation by Dr. Konstantin I.Samoilov, 2016

70. The «EUROPOLIS» residential complex, J.Omarova str., Almaty city, Kazakhstan
(2006-2014, arch. Konstantin I.Samoilov, “Europolis”) – the Building 7 section view (street № 33)

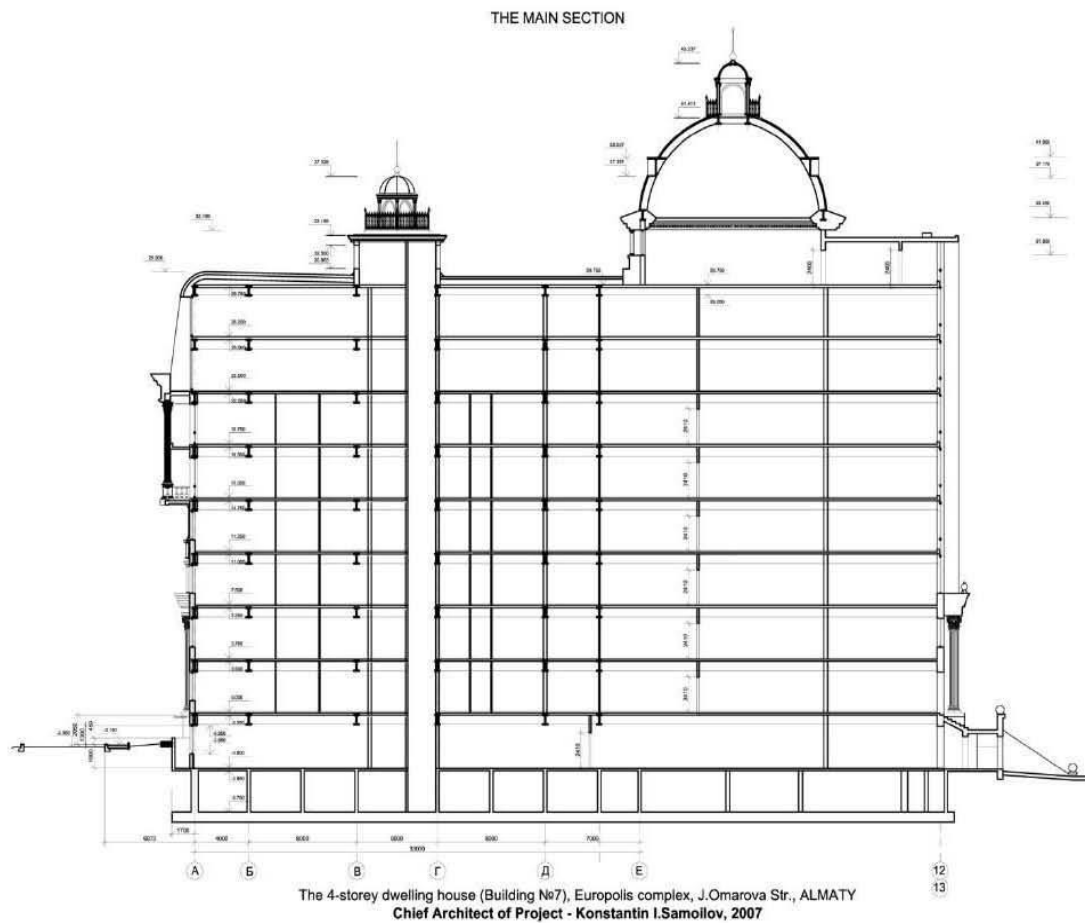

Source: the Project sketch, 2007

The «EUROPOLIS» residential complex, Almaty: a fantasy in Palladian style traditions

Ppt-Presentation by Dr. Konstantin I.Samoilov, 2016

71. The «EUROPOLIS» residential complex, J.Omarova str., Almaty city, Kazakhstan
(2006-2014, arch. Konstantin I.Samoilov, «Europolis») – the Building 8 under construction (street № 35)



Source: Photos by K.I.Samoilov, 2016

The «EUROPOLIS» residential complex, Almaty: a fantasy in Palladian style traditions

Ppt-Presentation by Dr. Konstantin I.Samoilov, 2016

72. The «EUROPOLIS» residential complex, J.Omarova str., Almaty city, Kazakhstan (2006-2014, arch. Konstantin I.Samoilov, “Europolis”) – the Section view (Buildings 6, 8, 10)

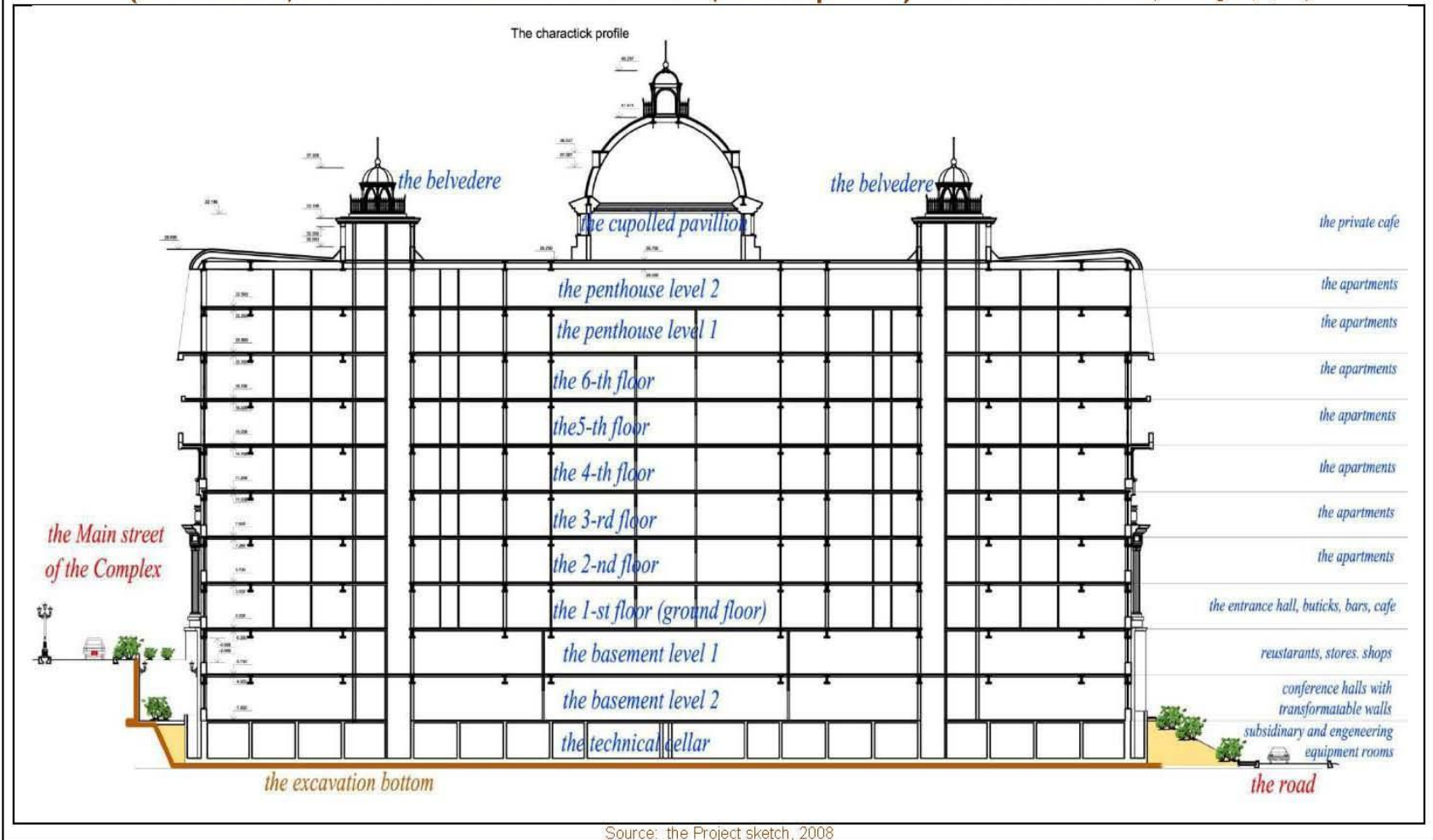

The «EUROPOLIS» residential complex, Almaty: a fantasy in Palladian style traditions

Ppt-Presentation by Dr. Konstantin I.Samoilov, 2016

73. The «EUROPOLIS» residential complex, J.Omarova str., Almaty city, Kazakhstan (2006-2014, arch. Konstantin I.Samoilov, “Europolis”) – the Building 10 under construction (street № 39)



Source: Photo by K.I. Samoilov, 2016

The «EUROPOLIS» residential complex, Almaty: a fantasy in Palladian style traditions

Ppt-Presentation by Dr. Konstantin I.Samoilov, 2016

**74. The «EUROPOLIS» residential complex, J.Omarova str., Almaty city, Kazakhstan
(2006-2014, arch. Konstantin I.Samoilov, “Europolis”) – the Building 8 under construction (street № 35)**



Source: Photo by K.I.Samoilov, 2016

The «EUROPOLIS» residential complex, Almaty: a fantasy in Palladian style traditions

Ppt-Presentation by Dr. Konstantin I.Samoilov, 2016

**75. The «EUROPOLIS» residential complex, J.Omarova str., Almaty city, Kazakhstan
(2006-2014, arch. Konstantin I.Samoilov, “Europolis”) – Buildings 7, 8, 6 (street №№ 33, 35, 31)**



Source: Photo by K.I.Samoilov, 2016

The «EUROPOLIS» residential complex, Almaty: a fantasy in Palladian style traditions

Ppt-Presentation by Dr. Konstantin I.Samoilov, 2016

76. The «EUROPOLIS» residential complex, J.Omarova str., Almaty city, Kazakhstan (2006-2014, arch. Konstantin I.Samoilov, “Europolis”) – the Apartments location (the Building 7)

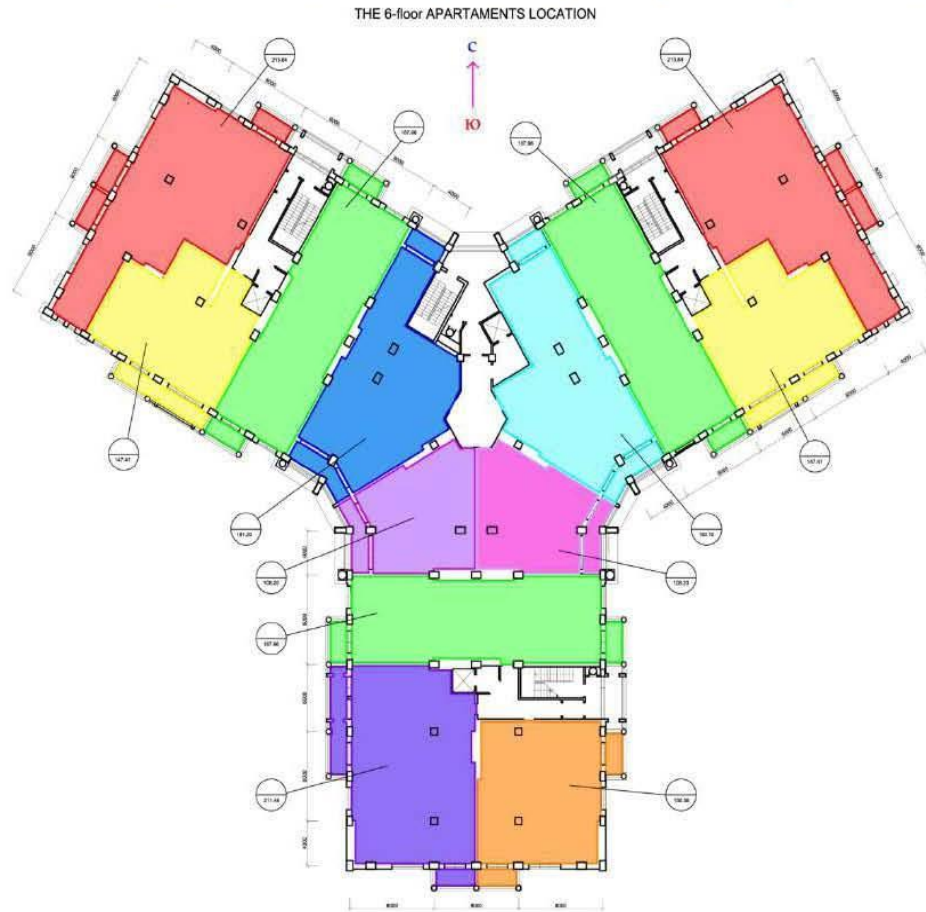

The 5-storey dwelling house (Building №7). Europolis complex, J.Omarova Str., ALMATY
Chief Architect of Project - Konstantin I.Samoilov, 2006

Source: the Project sketch, 2006

**77. The «EUROPOLIS» residential complex, J.Omarova str., Almaty city, Kazakhstan
(2006-2014, arch. Konstantin I.Samoilov, “Europolis”) – the Floor plan (the Building 7)**

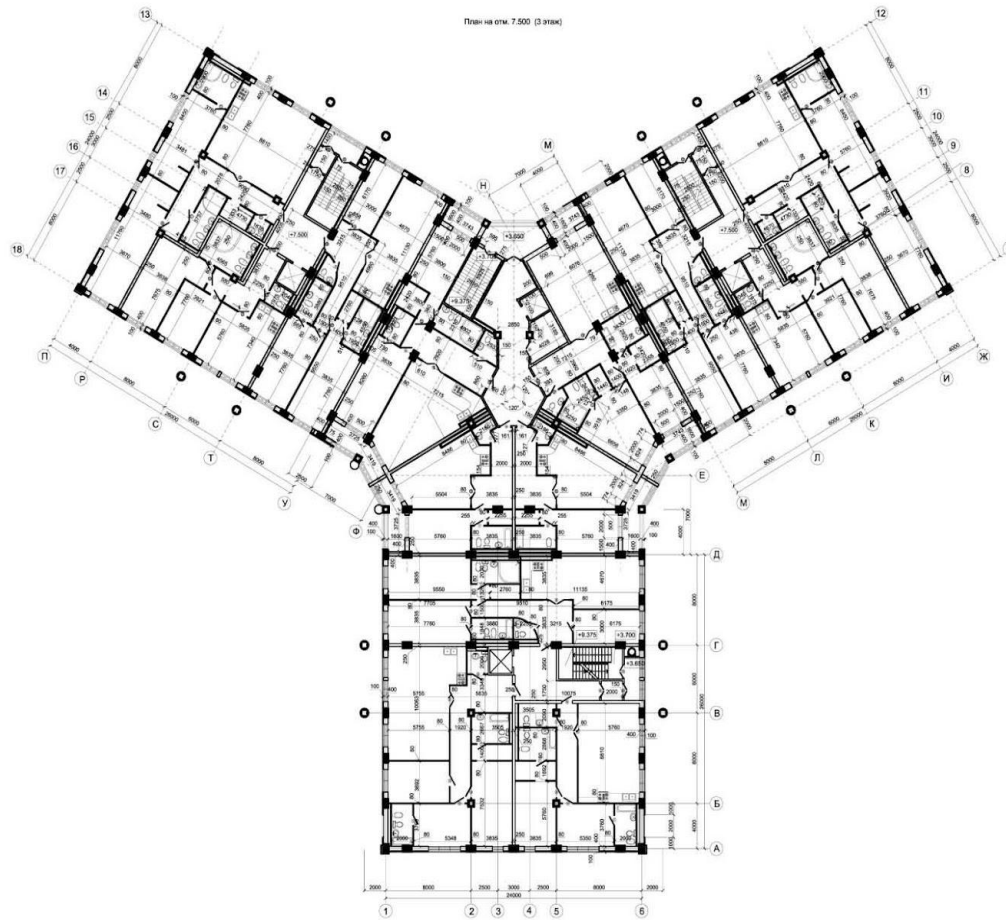

Source: the Project sketch, 2006

The «EUROPOLIS» residential complex, Almaty: a fantasy in Palladian style traditions

Ppt-Presentation by Dr. Konstantin I.Samoilov, 2016

**78. The «EUROPOLIS» residential complex, J.Omarova str., Almaty city, Kazakhstan
(2006-2014, arch. Konstantin I.Samoilov, “Europolis”) – the Building 7 (street № 33)**



Source: Photo by K.I.Samoilov, 2015

The «EUROPOLIS» residential complex, Almaty: a fantasy in Palladian style traditions

Ppt-Presentation by Dr. Konstantin I.Samoilov, 2016

79. The «EUROPOLIS» residential complex, J.Omarova str., Almaty city, Kazakhstan (2006-2014, arch. Konstantin I.Samoilov, «Europolis») – the Façade with the Grand dome (the Building 7)

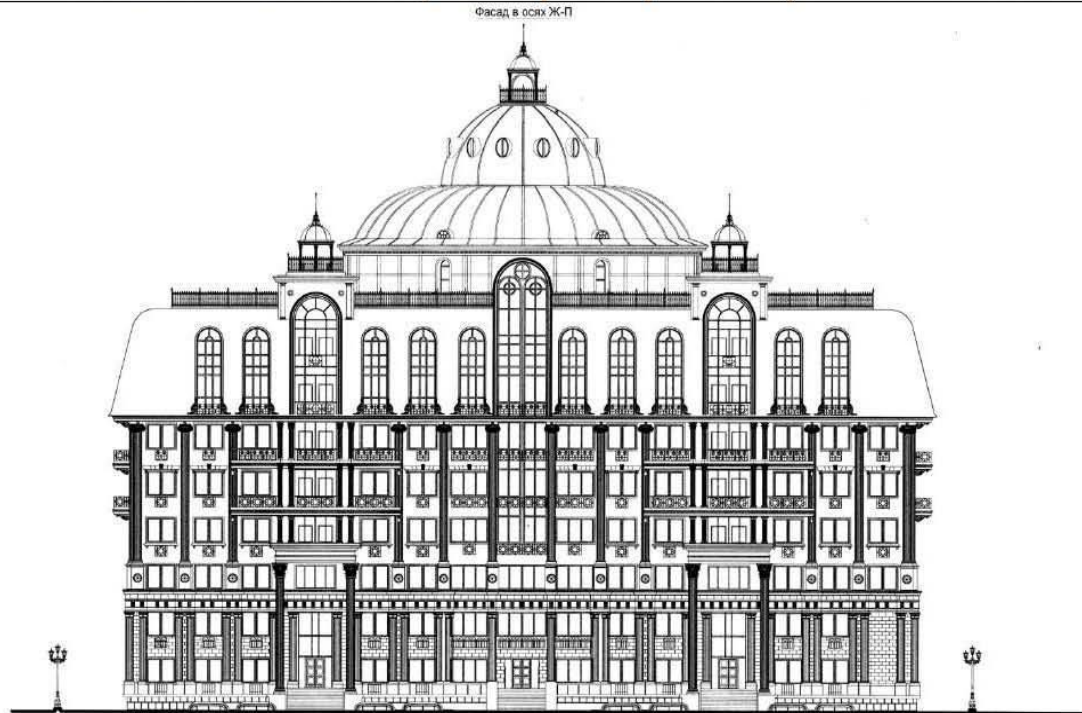

Сухово
30.03.07.

№ 10-07	
Информационный блок	
№ проекта	10-07
№ документа	Э
Дата	30.03.07.
Исполнитель	Сухово
Проверенный	Сухово
Утвержденный	Сухово
Дата утверждения	
Масштаб	1:100
Содержание	Фасад в осях Ж-П

Source: the Project sketch, 2007

The «EUROPOLIS» residential complex, Almaty: a fantasy in Palladian style traditions

Ppt-Presentation by Dr. Konstantin I.Samoilov, 2016

80. The «EUROPOLIS» residential complex, J.Omarova str., Almaty city, Kazakhstan
(2006-2014, arch. Konstantin I.Samoilov, «Europolis») – the Façade with the Grand dome (the Building 7)

Фасад в осях 1-6

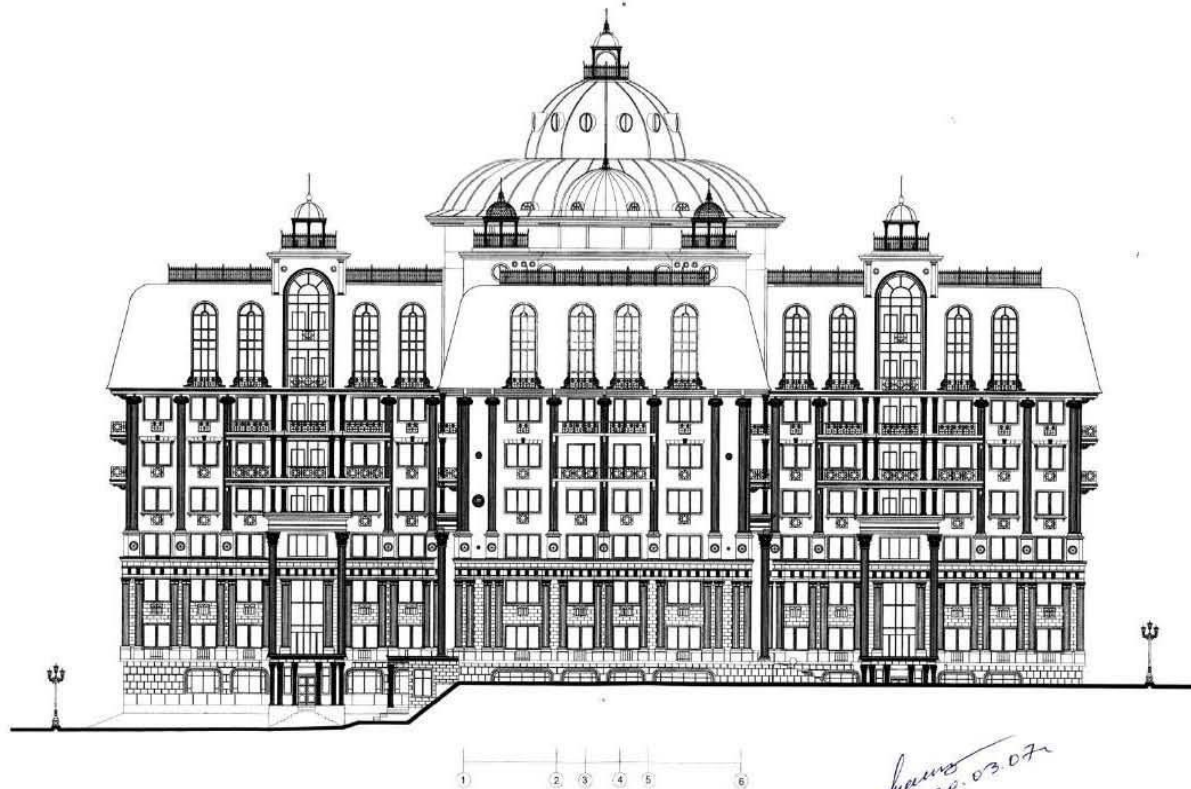

№	1	2	3	4	5	6
Имя						
Фамилия						
Дата						

Source: the Project sketch, 2007

The «EUROPOLIS» residential complex, Almaty: a fantasy in Palladian style traditions

Ppt-Presentation by Dr. Konstantin I. Samoilov, 2016

**81. The «EUROPOLIS» residential complex, J.Omarova str., Almaty city, Kazakhstan
(2006-2014, arch. Konstantin I.Samoilov, “Europolis”) – the Building 7 (street № 33)**



Source: Photo by K.I. Samoilov, 2015

The «EUROPOLIS» residential complex, Almaty: a fantasy in Palladian style traditions

Ppt-Presentation by Dr. Konstantin I.Samoilov, 2016

**82. The «EUROPOLIS» residential complex, J.Omarova str., Almaty city, Kazakhstan
(2006-2014, arch. Konstantin I.Samoilov, “Europolis”) – the Building 7 (street № 33)**



Source: Photo by K.I. Samoilov, 2015

The «EUROPOLIS» residential complex, Almaty: a fantasy in Palladian style traditions

Ppt-Presentation by Dr. Konstantin I.Samoilov, 2016

**84. The «EUROPOLIS» residential complex, J.Omarova str., Almaty city, Kazakhstan
(2006-2014, arch. Konstantin I.Samoilov, “Europolis”) – the Building 7 (street № 33)**



Source: Photo by K.I. Samoilov, 2015

The «EUROPOLIS» residential complex, Almaty: a fantasy in Palladian style traditions

Ppt-Presentation by Dr. Konstantin I.Samoilov, 2016

**85. The «EUROPOLIS» residential complex, J.Omarova str., Almaty city, Kazakhstan
(2006-2014, arch. Konstantin I.Samoilov, “Europolis”) – the Building 9 (street № 37)**



Source: Photo by K.I.Samoilov, 2016

The «EUROPOLIS» residential complex, Almaty: a fantasy in Palladian style traditions

Ppt-Presentation by Dr. Konstantin I.Samoilov, 2016

**86. The «EUROPOLIS» residential complex, J.Omarova str., Almaty city, Kazakhstan
(2006-2014, arch. Konstantin I.Samoilov, «Europolis») – Porches of offices (the Building 7)**



Source: Photo by K.I. Samoilov, 2015

The «EUROPOLIS» residential complex, Almaty: a fantasy in Palladian style traditions

Ppt-Presentation by Dr. Konstantin I.Samoilov, 2016

87. The «EUROPOLIS» residential complex, J.Omarova str., Almaty city, Kazakhstan (2006-2014, arch. Konstantin I.Samoilov, “Europolis”) – Gardening and landscaping (the Building 7)

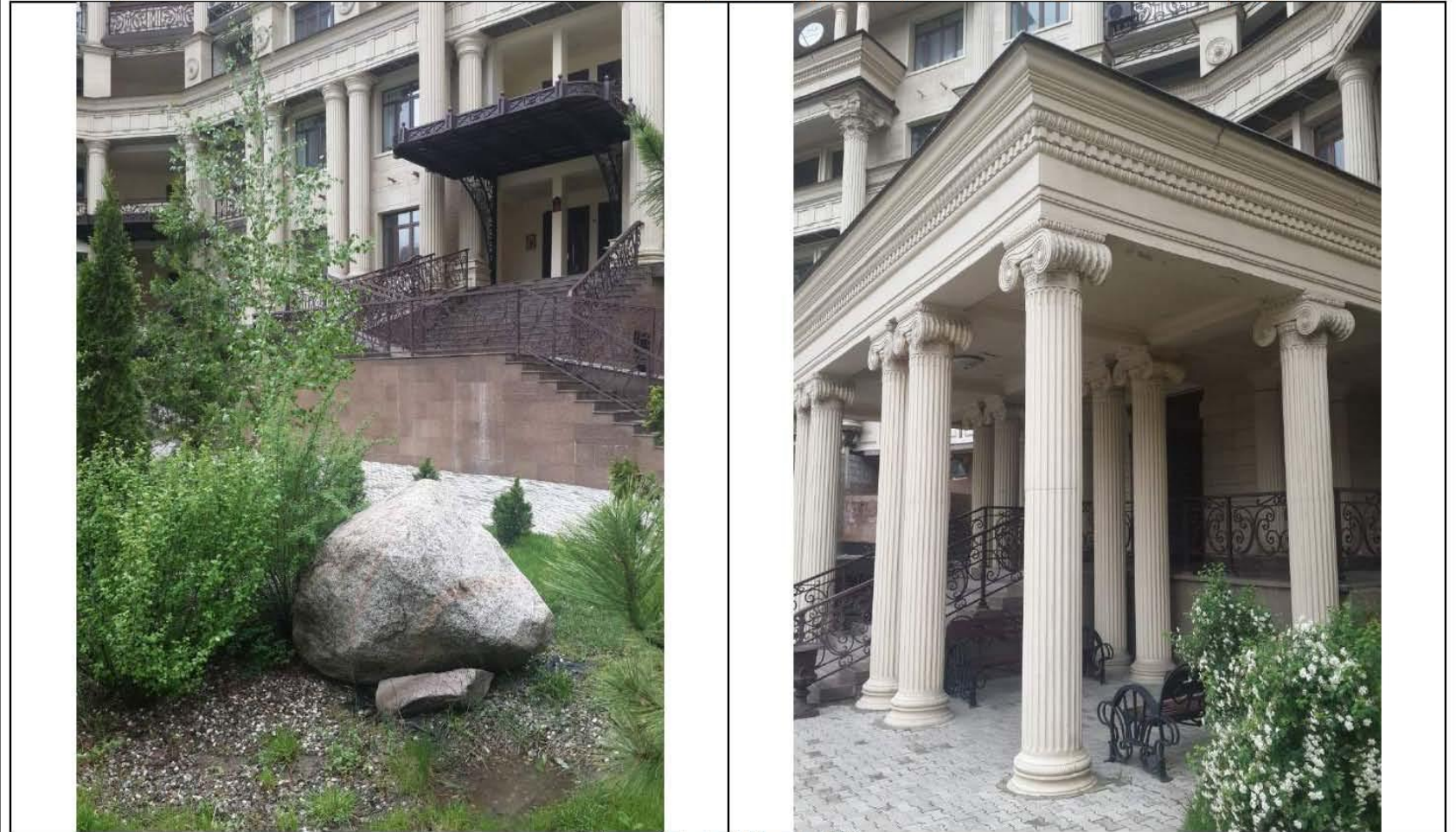

Source: Photos by K.I.Samoilov, 2016

The «EUROPOLIS» residential complex, Almaty: a fantasy in Palladian style traditions

Ppt-Presentation by Dr. Konstantin I.Samoilov, 2016

88. The «EUROPOLIS» residential complex, J.Omarova str., Almaty city, Kazakhstan
(2006-2014, arch. Konstantin I.Samoilov, «Europolis») – Gardening and landscaping (Buildings 9,7)



Source: Photos by K.I.Samoilov, 2016

The «EUROPOLIS» residential complex, Almaty: a fantasy in Palladian style traditions

Ppt-Presentation by Dr. Konstantin I.Samoilov, 2016

89. The «EUROPOLIS» residential complex, J.Omarova str., Almaty city, Kazakhstan (2006-2014, arch. Konstantin I.Samoilov, “Europolis”) – Apartments hall's porches (the Building 7)



Source: Photo by K.I.Samoilov, 2015

The «EUROPOLIS» residential complex, Almaty: a fantasy in Palladian style traditions

Ppt-Presentation by Dr. Konstantin I.Samoilov, 2016

90. The «EUROPOLIS» residential complex, J.Omarova str., Almaty city, Kazakhstan
(2006-2014, arch. Konstantin I.Samoilov, «Europolis») – Commercial aria's porches (the Building 9)



Source: Photo by K.I. Samoilov, 2015

The «EUROPOLIS» residential complex, Almaty: a fantasy in Palladian style traditions

Ppt-Presentation by Dr. Konstantin I.Samoilov, 2016

91. The «EUROPOLIS» residential complex, J.Omarova str., Almaty city, Kazakhstan (2006-2014, arch. Konstantin I.Samoilov, «Europolis») – Gardening and landscaping (the Building 7)



Source: Photos by K.I.Samoilov, 2016

The «EUROPOLIS» residential complex, Almaty: a fantasy in Palladian style traditions

Ppt-Presentation by Dr. Konstantin I. Samoilov, 2016

**92. The «EUROPOLIS» residential complex, J.Omarova str., Almaty city, Kazakhstan
(2006-2014, arch. Konstantin I.Samoilov, “Europolis”) – the Gallery porch (the Building 7)**



Source: Photo by K.I. Samoilov, 2016

The «EUROPOLIS» residential complex, Almaty: a fantasy in Palladian style traditions

Ppt-Presentation by Dr. Konstantin I.Samoilov, 2016

**93. The «EUROPOLIS» residential complex, J.Omarova str., Almaty city, Kazakhstan
(2006-2014, arch. Konstantin I.Samoilov, «Europolis») – Gardening and landscaping (the Building 9)**



Source: Photo by K.I.Samoilov, 2016

The «EUROPOLIS» residential complex, Almaty: a fantasy in Palladian style traditions

Ppt-Presentation by Dr. Konstantin I.Samoilov, 2016

**94. The «EUROPOLIS» residential complex, J.Omarova str., Almaty city, Kazakhstan
(2006-2014, arch. Konstantin I.Samoilov, “Europolis”) – Buildings 7, 9, 6 (street №№ 33, 37, 31)**

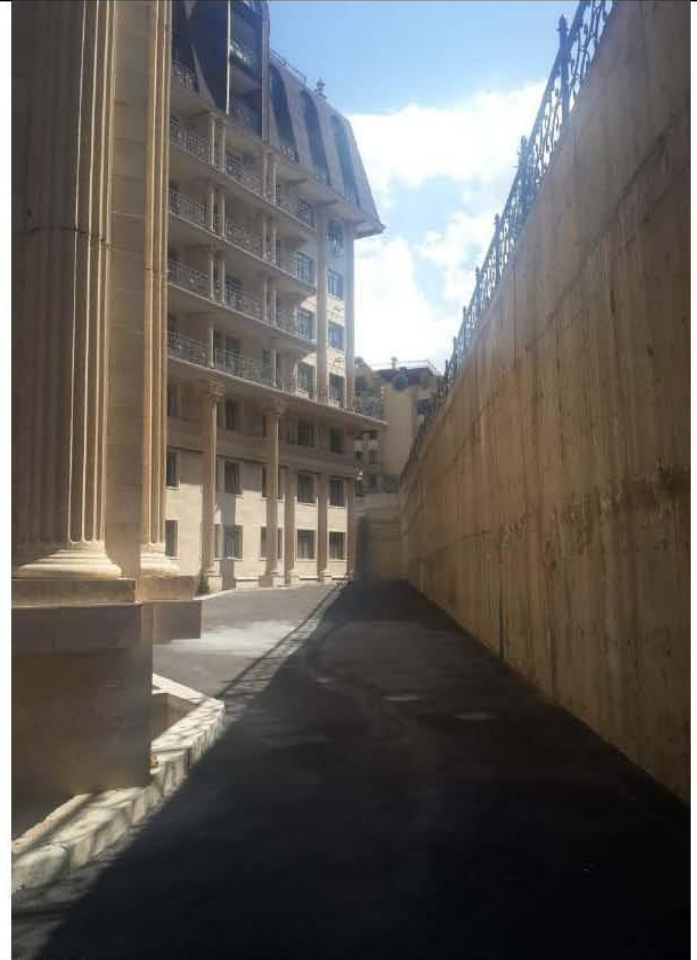
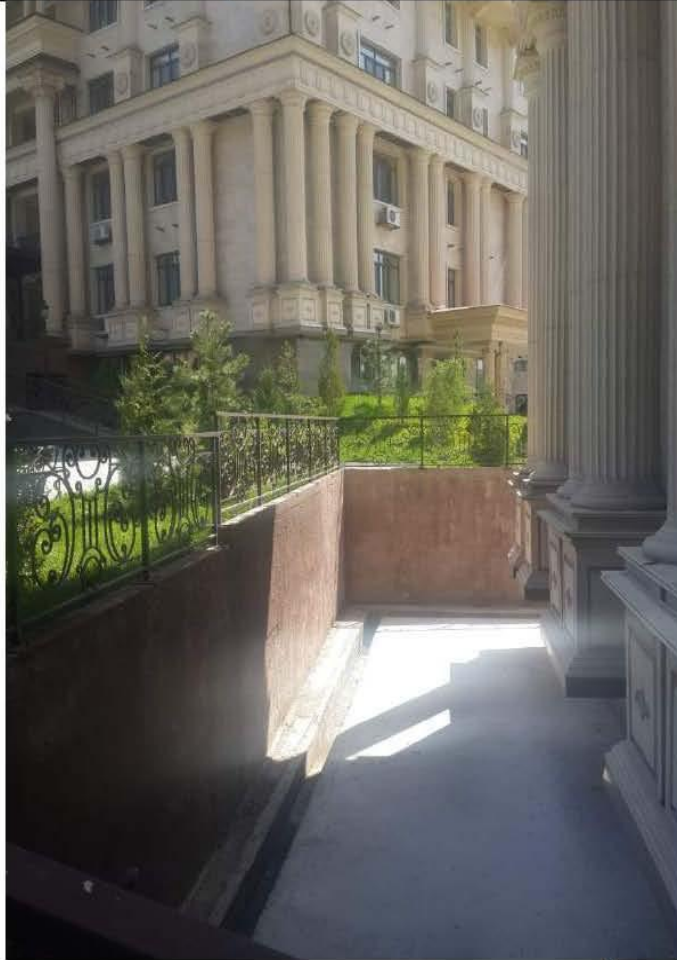

Source: Photos by K.I.Samoilov, 2016

The «EUROPOLIS» residential complex, Almaty: a fantasy in Palladian style traditions

Ppt-Presentation by Dr. Konstantin I.Samoilov, 2016

**95. The «EUROPOLIS» residential complex, J.Omarova str., Almaty city, Kazakhstan
(2006-2014, arch. Konstantin I.Samoilov, “Europolis”) – Buildings 9, 6 (street №№ 37, 31)**



Source: Photos by K.I.Samoilov, 2016

The «EUROPOLIS» residential complex, Almaty: a fantasy in Palladian style traditions

Ppt-Presentation by Dr. Konstantin I.Samoilov, 2016

96. The «EUROPOLIS» residential complex, J.Omarova str., Almaty city, Kazakhstan
(2006-2014, arch. Konstantin I.Samoilov, “Europolis”) – the Building 6 (street № 31)



Source: Photo by K.I.Samoilov, 2016

The «EUROPOLIS» residential complex, Almaty: a fantasy in Palladian style traditions

Ppt-Presentation by Dr. Konstantin I.Samoilov, 2016

97. The «EUROPOLIS» residential complex, J.Omarova str., Almaty city, Kazakhstan
(2006-2014, arch. Konstantin I.Samoilov, «Europolis») – the Office porch (the Building 7)



Source: Photo by K.I. Samoilov, 2015

The «EUROPOLIS» residential complex, Almaty: a fantasy in Palladian style traditions

Ppt-Presentation by Dr. Konstantin I.Samoilov, 2016

98. The «EUROPOLIS» residential complex, J.Omarova str., Almaty city, Kazakhstan
(2006-2014, arch. Konstantin I.Samoilov, “Europolis”) – Office halls (the Building 7)



Source: Photos by K.I.Samoilov, 2016

The «EUROPOLIS» residential complex, Almaty: a fantasy in Palladian style traditions

Ppt-Presentation by Dr. Konstantin I.Samoilov, 2016

99. The «EUROPOLIS» residential complex, J.Omarova str., Almaty city, Kazakhstan (2006-2014, arch. Konstantin I.Samoilov, “Europolis”) – Office halls (the Building 7)



Source: Photos by K.I.Samoilov, 2016

The «EUROPOLIS» residential complex, Almaty: a fantasy in Palladian style traditions

Ppt-Presentation by Dr. Konstantin I.Samoilov, 2016

**100. The «EUROPOLIS» residential complex, J.Omarova str., Almaty city, Kazakhstan
(2006-2014, arch. Konstantin I.Samoilov, “Europolis”) – the Pre-apartments hall (the Building 9)**



Source: Photos by K.I.Samoilov, 2016

The «EUROPOLIS» residential complex, Almaty: a fantasy in Palladian style traditions

Ppt-Presentation by Dr. Konstantin I.Samoilov, 2016

101. The «EUROPOLIS» residential complex, J.Omarova str., Almaty city, Kazakhstan (2006-2014, arch. Konstantin I.Samoilov, “Europolis”) – the Pre-apartments hall (the Building 9)



Source: Photo by K.I.Samoilov, 2016

The «EUROPOLIS» residential complex, Almaty: a fantasy in Palladian style traditions

Ppt-Presentation by Dr. Konstantin I.Samoilov, 2016

**102. The «EUROPOLIS» residential complex, J.Omarova str., Almaty city, Kazakhstan
(2006-2014, arch. Konstantin I.Samoilov, “Europolis”) – the Building 6 (street № 31)**



Source: Photo by K.I.Samoilov, 2016

The «EUROPOLIS» residential complex, Almaty: a fantasy in Palladian style traditions

Ppt-Presentation by Dr. Konstantin I.Samoilov, 2016

103. The «EUROPOLIS» residential complex, J.Omarova str., Almaty city, Kazakhstan
(2006-2014, arch. Konstantin I.Samoilov, “Europolis”) – the Restaurant porch



Source: Photo by K.I.Samoilov, 2016

The «EUROPOLIS» residential complex, Almaty: a fantasy in Palladian style traditions

Ppt-Presentation by Dr. Konstantin I.Samoilov, 2016

104. The «EUROPOLIS» residential complex, J.Omarova str., Almaty city, Kazakhstan (2006-2014, arch. Konstantin I.Samoilov, “Europolis”) – the Restaurant porch



Source: Photo by K.I.Samoilov, 2016

The «EUROPOLIS» residential complex, Almaty: a fantasy in Palladian style traditions

Ppt-Presentation by Dr. Konstantin I.Samoilov, 2016

105. The «EUROPOLIS» residential complex, J.Omarova str., Almaty city, Kazakhstan (2006-2014, arch. Konstantin I.Samoilov, «Europolis») – the Restaurant porch



Source: Photo by K.I.Samoilov, 2016

The «EUROPOLIS» residential complex, Almaty: a fantasy in Palladian style traditions

Ppt-Presentation by Dr. Konstantin I.Samoilov, 2016

**106. The «EUROPOLIS» residential complex, J.Omarova str., Almaty city, Kazakhstan
(2006-2014, arch. Konstantin I.Samoilov, “Europolis”) – the Carwash box**



Source: Photo by K.I.Samoilov, 2016

**107. The «EUROPOLIS» residential complex, J.Omarova str., Almaty city, Kazakhstan
(2006-2014, arch. Konstantin I.Samoilov, «Europolis») – the Lion macaron (the Service building)**



Source: Photo by K.I.Samoilov, 2016

108. The «EUROPOLIS» residential complex, J.Omarova str., Almaty city, Kazakhstan (2006-2014, arch. Konstantin I.Samoilov, “Europolis”) – References

1. Palladio, A. 1989 'Four Books on the Architecture'. = Палладио А. Четыре книги по архитектуре. // Пер. с итал. И.В.Жолтовского; Под ред. А.Г.Габричевского. – Факс. Изд. – Москва: Стройиздат, 1989. – 352 с.
2. Europolis Complex Almaty, Kazakhstan. - <http://architizer.com/projects/europolis-complex/>
3. Комплекс «Европолис». – www.europolis.kz
4. Photo of Europolis residential complex, Almaty - the Main Gate. - <http://www.free-photos.biz/temp/8fab823b5355162d77c76105e0c12170>
5. Photo of Europolis residential complex, Almaty - the Main Street. - <http://www.free-photos.biz/temp/780e4a94e4c1cfaa51638bd942e7267a>
6. Photo of Europolis residential complex, Almaty - the Office Block. - <http://www.free-photos.biz/temp/8526d8e43e109139b12214471832515f>
7. Photo of Europolis residential complex, Almaty - the Main Office porch. - <http://www.free-photos.biz/temp/96f99f44755f7223f513cbd584af9044>
8. Photo of Europolis residential complex, Almaty - Porches of offices. - <http://www.free-photos.biz/temp/2a354192cb06a6ec50dcfd590ba4d009>
9. Photo of Europolis residential complex, Almaty – the Building 2. - <http://www.free-photos.biz/temp/5c5addbb49a2641ea8871cc6e56d3365>
10. Photo of Europolis residential complex, Almaty – the Building 7. - <http://www.free-photos.biz/temp/498a0dd9f21cc3cbbc9cd562be695055>
11. Photo of Europolis residential complex, Almaty – the Building 5. - <http://www.free-photos.biz/temp/35a6168a82f06c7252432f23802f7d5b>
12. Photo of Europolis residential complex, Almaty – the Building 5, one-volute twin capitals. - <http://www.free-photos.biz/temp/d4635d56d1e389c498ac10b06e426893>
13. Photo of Europolis residential complex, Almaty – the Building 3. - <http://www.free-photos.biz/temp/b7a36605e9bca9b507acf6b6bbf4029b>

109. The «EUROPOLIS» residential complex, J.Omarova str., Almaty city, Kazakhstan (2006-2014, arch. Konstantin I.Samoilov, “Europolis”) – References

14. The Kazakhstan's Architecture of the 21st century in the World Architectural context. - The Album of typical examples by Dr. Konstantin I.Samoilov, 2016. - <http://www.slideshare.net/KonstantinIvanovichS/the-kazakhstans-architecture-of-the-21st-century-in-the-world-architectural-context-the-album-of-typical-examples-by-dr-konstantin-isamoilov-2016> ; <http://www.twirpx.com/file/1923398/>
15. The Kazakhstan's Architecture of the 21st century (2000-2009) in the World Architectural context. - The Album of typical examples by Dr. Konstantin I.Samoilov, 2016. - <https://ru.scribd.com/doc/305854412/THE-KAZAKHSTAN-S-ARCHITECTURE-OF-THE-21st-CENTURY-2000-2009-IN-THE-WORLD-ARCHITECTURAL-CONTEXT-The-Album-of-typical-examples-by-Dr-Konstantin-I-S>
16. The Kazakhstan's Architecture of the 21st century (2000-2009) in the World Architectural context / Typical examples by Dr. Konstantin I.Samoilov. – Almaty, 2016. – ppt-Presentation. - 80 p. - <http://uslide.ru/mhk/33805-te-kazakstans-arcitecture-of-te-st-century-in-te-o.html> ; <http://ppt4web.ru/mkhk/te-kazakstans-arcitecture-of-te-st-century-in-te-orld-arcitectural-contet-typical-eamples-by-dr-konstantin-isamoilov-almaty-pptpresentation-p.html> ; <http://infourok.ru/te-kazakstans-arcitecture-of-te-st-century-in-te-orld-arcitectural-contet-typical-eamples-by-dr-konstantin-isamoilov-almaty-pptp-1020821.html> ; <http://bigslide.ru/mhk/24722-te-kazakstans-arcitecture-of-te-st-century-in-te-o.html> ; <http://slideplayer.com/slide/10152063/> ; <http://www.slideserve.com/samconiv/the-kazakhstan-s-architecture-of-the-21st-century-2000-2009-in-the-world-architectural-context-typical-examples-by-d>
17. The Kazakhstan's Architecture of the 21st century Beginning (Trends of Forms Evolution) - The Album of typical examples by Dr. Konstantin I.Samoilov, 2016. – 104 p. - <http://www.slideshare.net/KonstantinIvanovichS/kazakhstans-architecture-of-the-21st-century-beginning-trends-of-forms-evolution-the-album-of-typical-examples-by-dr-konstantin-isamoilov-2016> ; <http://www.twirpx.com/file/1923405/> ; <https://ru.scribd.com/doc/305853936/KAZAKHSTAN-s-ARCHITECTURE-OF-THE-21st-CENTURY-BEGINNING-TRENDS-OF-FORMS-EVOLUTION-The-Album-of-typical-examples-by-Dr-Konstantin-I-Samoilov-2016>
18. The Kazakhstan's Architecture of the 21st century Beginning (Trends of Forms Evolution) / Typical examples by Dr. Konstantin I.Samoilov. – Almaty, 2016. – ppt-Presentation. - 89 p. – <http://uslide.ru/mhk/33803-te-kazakstans-arcitecture-of-te-st-century-beginni.html> ; <http://ppt4web.ru/mkhk/te-kazakstans-arcitecture-of-te-st-century-beginning-trends-of-forms-evolution-typical-eamples-by-dr-konstantin-isamoilov-almaty-pptpresentation-p.html> ; <http://infourok.ru/te-kazakstans-arcitecture-of-te-st-century-beginning-trends-of-forms-evolution-typical-eamples-by-dr-konstantin-isamoilov-almaty-1019771.html> ; <http://bigslide.ru/mhk/24718-te-kazakstans-arcitecture-of-te-st-century-beginni.html> ; <http://slideplayer.com/slide/10152066/>

Briefly about the Author



Konstantin I.SAMOILOV

High Doctorate (Arch) – 2008,
Doctor of Sciences (Arch) – 2004,
Candidate of Sciences / eq. PhD(Arch) – 1990,
Dipl.Arch. / eq. MArch – 1983,
Dipl.Tech.Arch. / eq. BArch – 1977

Associate Professor of the Architectural Faculty –
Kazakh Leading Academy of Architecture and Civil Engineering –
www.kazgasa.kz

Head of the Project Department, Chief Architect of projects –
“Europolis” LLP –
www.europolis.kz

E: samconiv@yahoo.com , samconiv@mail.ru





**The “EUROPOLIS” Residential Complex:
a fantasy in Palladian style traditions**
ppt-Presentation by Dr. Konstantin I.Samoilov.

Almaty, 2016. – 111 p.