

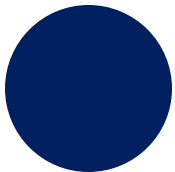

ЗДРАВСТВУЙТЕ



Учитель



Ученики

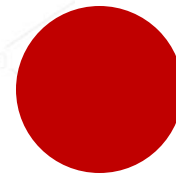

**Колокольчик нам поёт,
Всех на музыку зовёт,
Слышишь тонкий голосок,
Нам пора начать урок**



**Дин-дон.
Дин-дон.
Здравствуйт**



Здравствуйте.











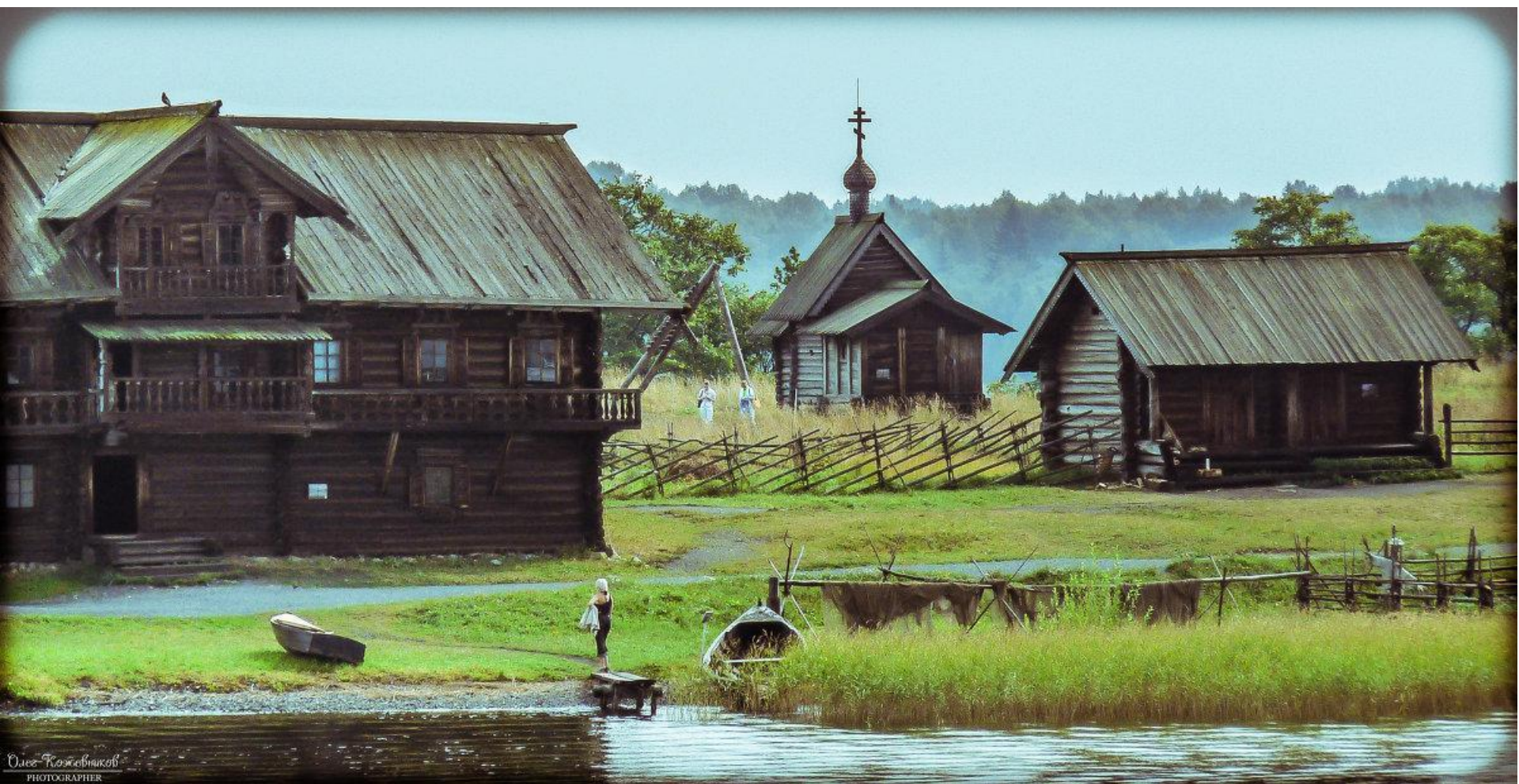





КИЖИ
KIZHI

Музей-заповедник «Кижский полог»

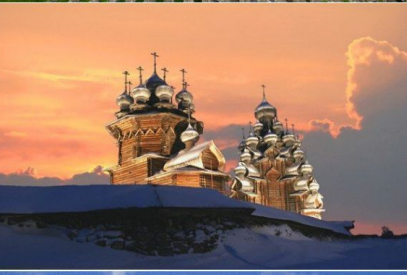

**Кижы, Кижы, Кижы –
Быль, а может, небыль.
Кижы, Кижы, Кижы –
Купола до неба.**

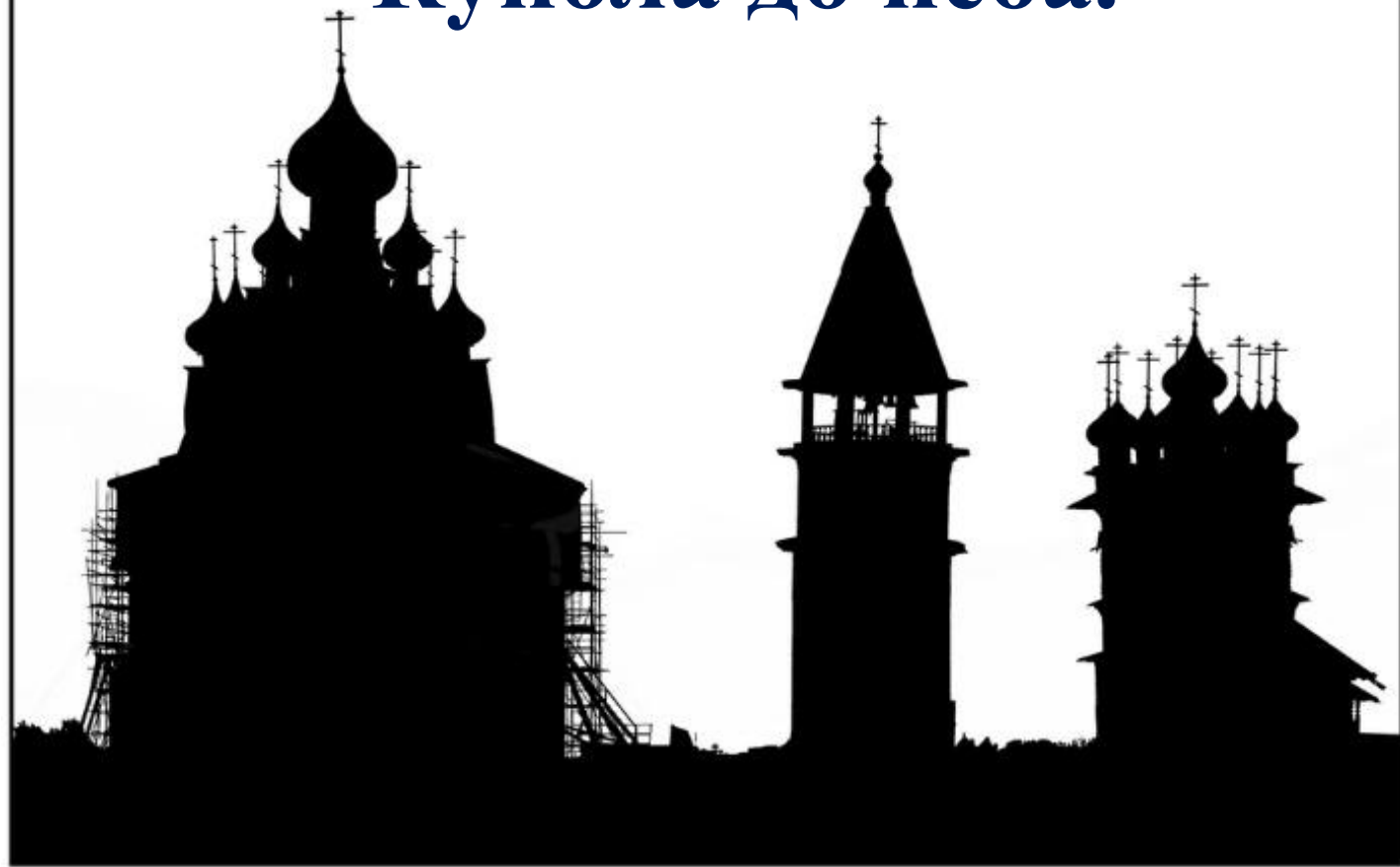

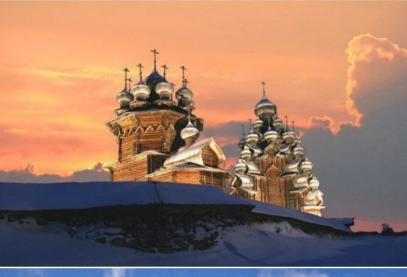

**Кижы, Кижы, Кижы –
Всё нам расскажите,
Красотой своею
Душу озарите!**



**Кижы, Кижы, Кижы –
Быль, а может, небыль.
Кижы, Кижы, Кижы –
Купола до неба.**



**Кижы, Кижы, Кижы –
её нам расскажите,
Красотой своею
Душу озарите!**





Кижский архитектурный ансамбль

КОЛОКОЛЬНЯ

Башня

Верхний ярус

ЗВОННИЦА



**Шатровая колокольня
Построена в 1863г.**





БОРОНЕЖ 1993





БОМ... БОМ...

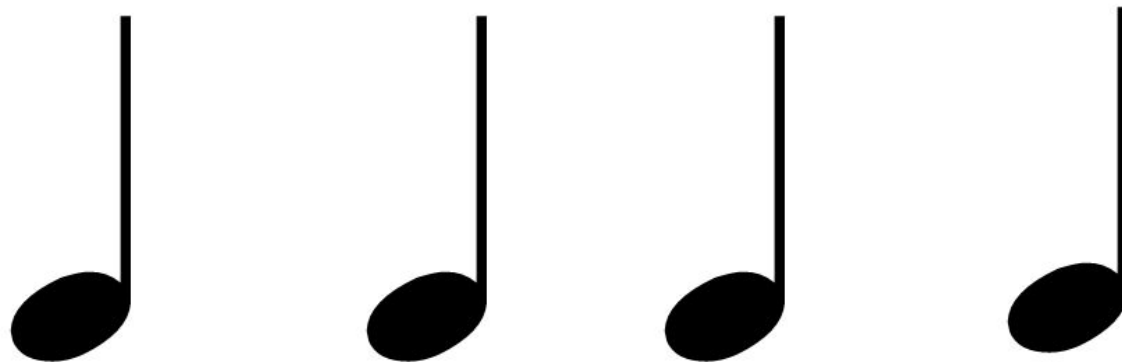

Дин - дон, дин — дон

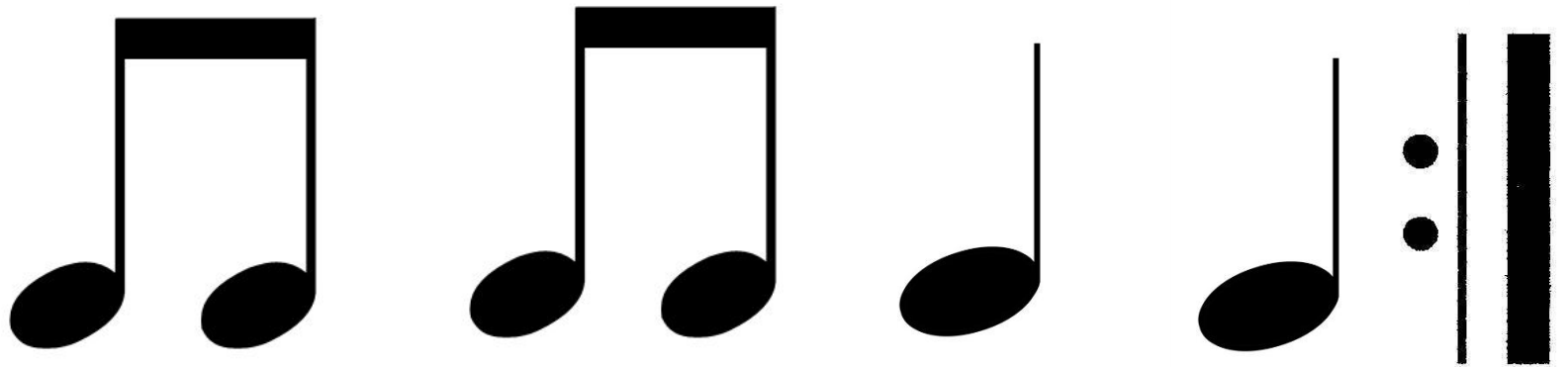

Дили - дили - дон-дон

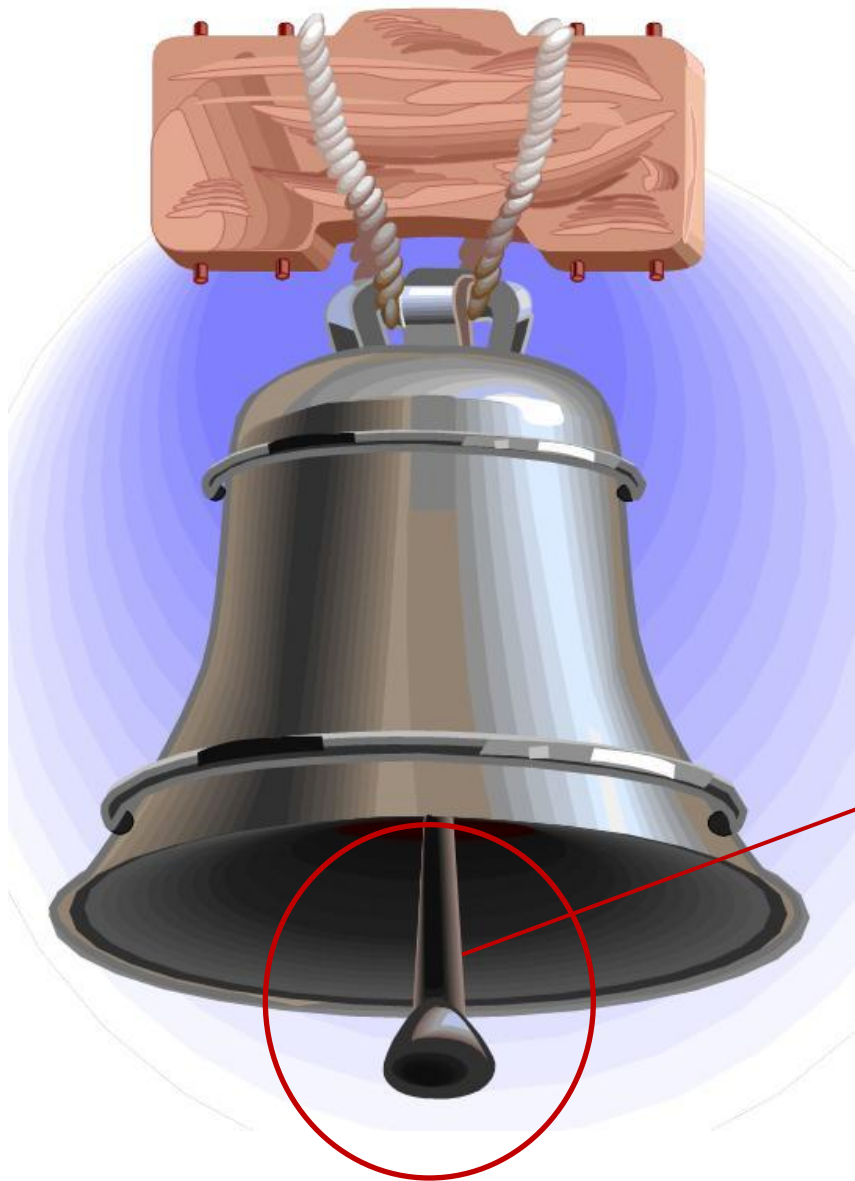

ЯЗЫК

**металлический
стержень
в колоколе или
колокольчике**

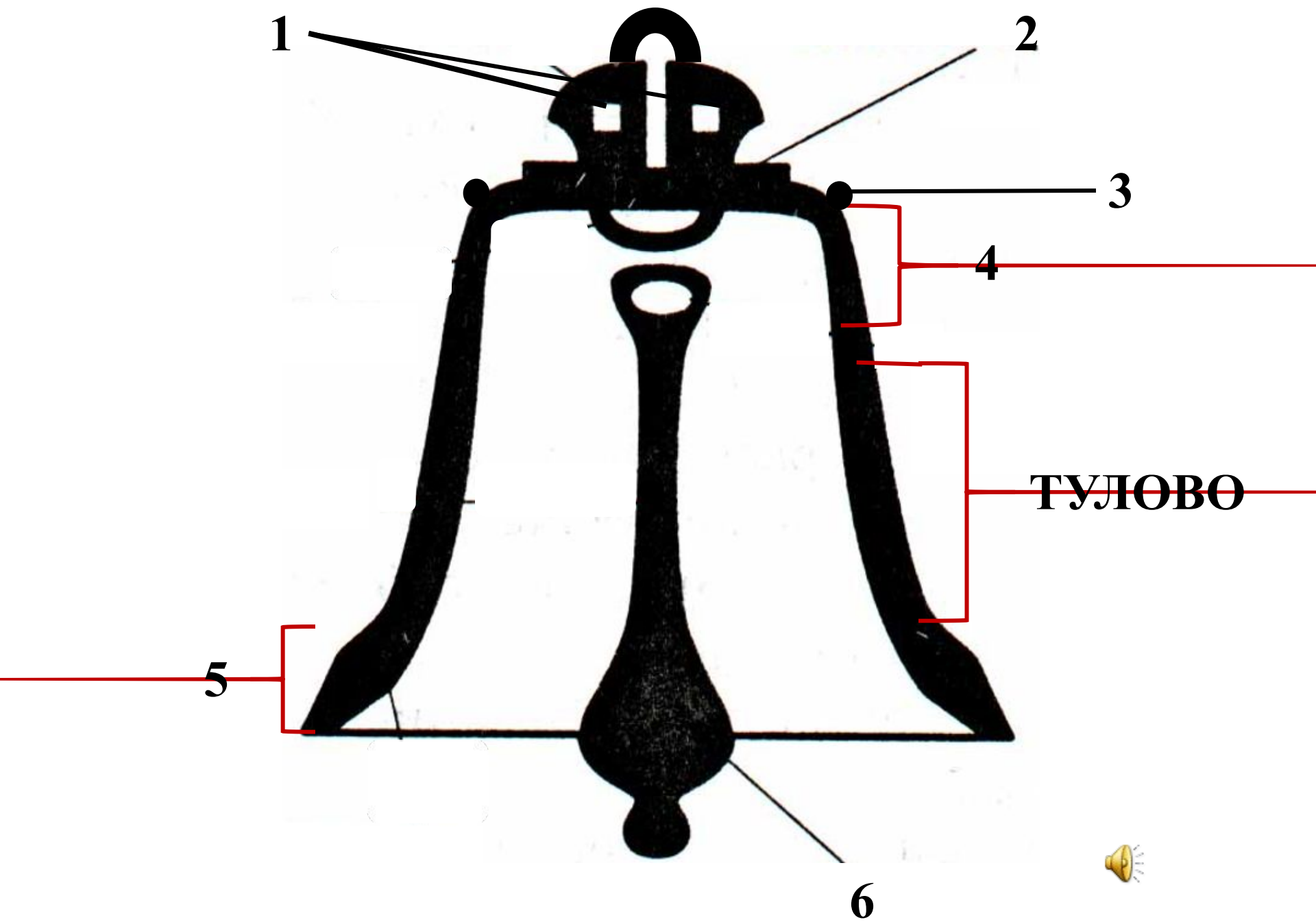

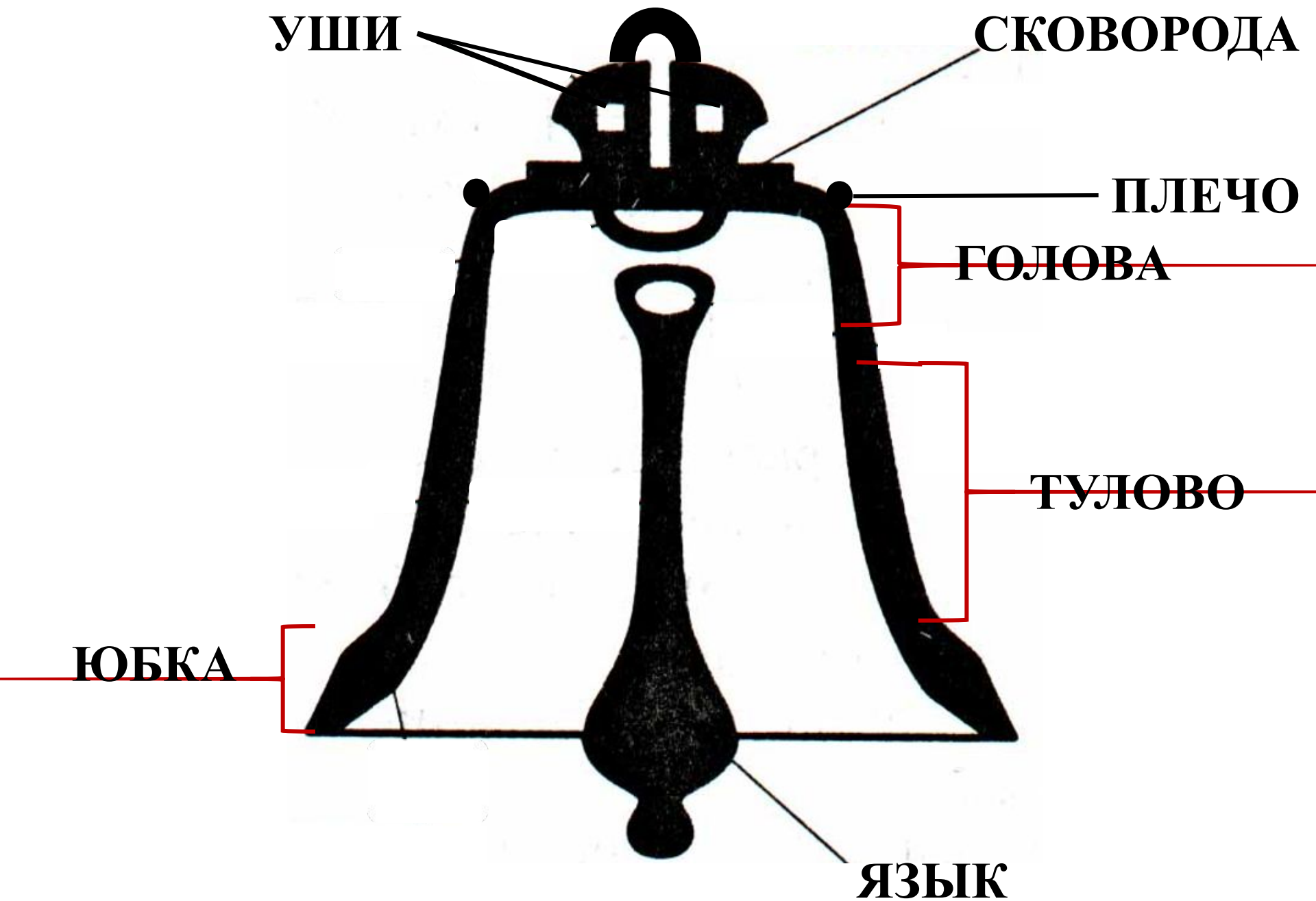





В	А	Ь	З	Н	Р	О
----------	----------	----------	----------	----------	----------	----------



З	В	О	Н	А	Р	Ь
----------	----------	----------	----------	----------	----------	----------

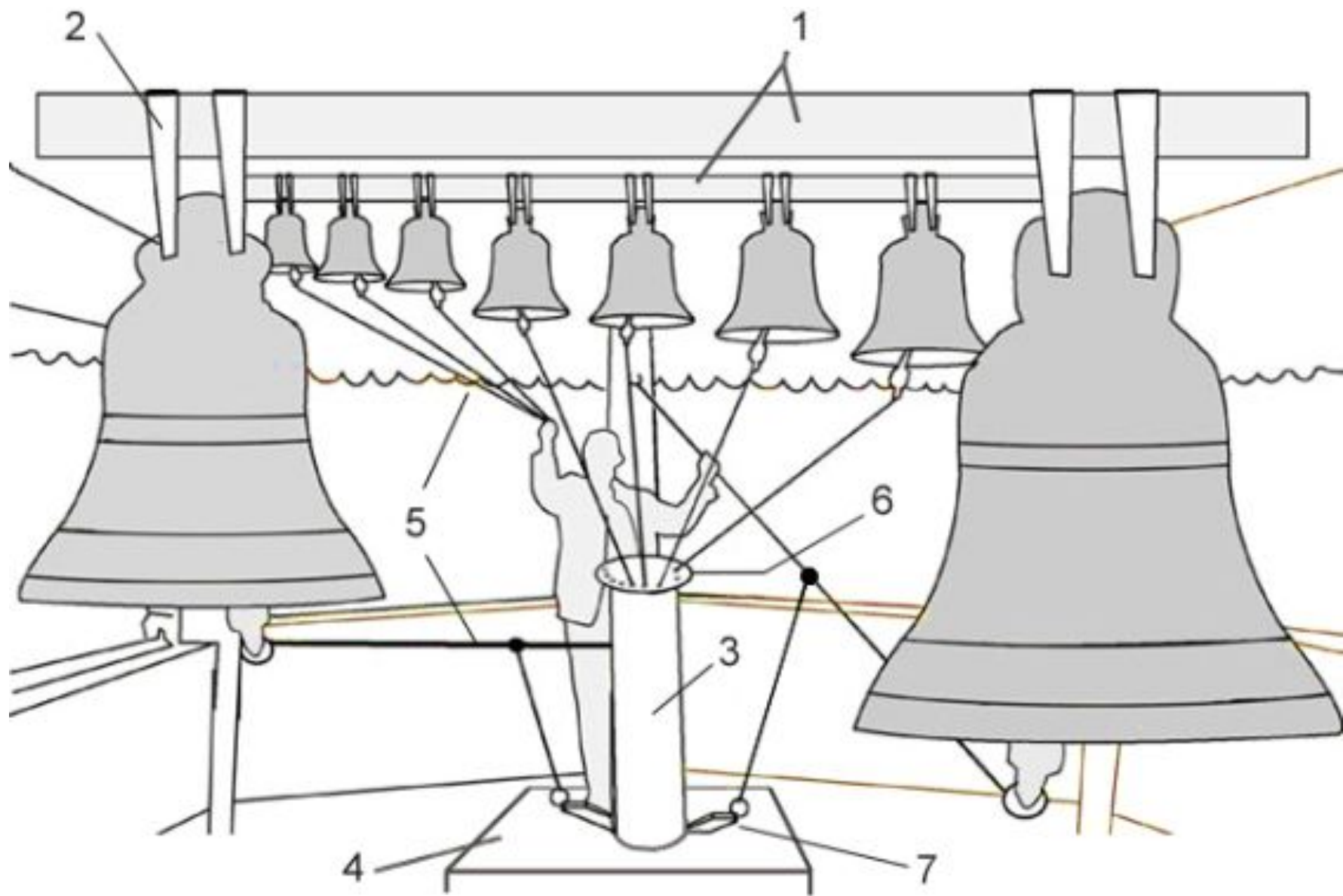



- Что нам сегодня удалось посетить на острове Кижии?

- Что нового вы узнали в путешествии?

- Что особенно вам сегодня запомнилось?

- Что вы можете рассказать своим родителям о нашем путешествии?



Ребята, выразите свое впечатление от путешествия

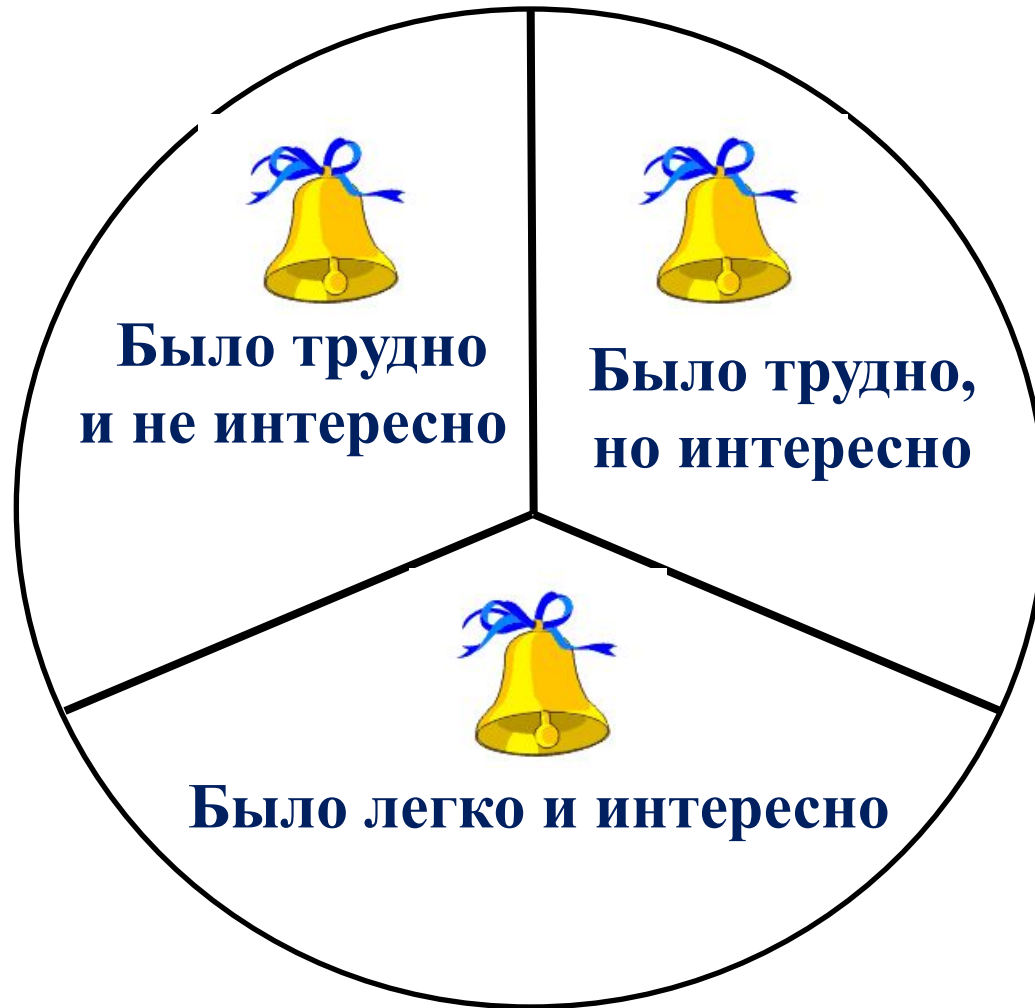



КИЖИ – чудо-остров

**Кто хоть раз здесь побывает,
Неприменно возвратится,
Чтобы кижским куполам
За красу их поклониться.**



**Кижы, Кижы, Кижы –
Быль, а может, небыль.
Кижы, Кижы, Кижы –
Купола до неба.**



**Кижы, Кижы, Кижы –
её нам расскажите,
Красотой своею
Душу озарите!**





A large, golden, curved swoosh that starts on the left and curves upwards and then downwards, framing the text.

ДО СВИДАНЬЯ!

