

«ARTEC BLOCKS»

ЛОГИЧЕСКИЙ

МИНИ-КВЕСТ

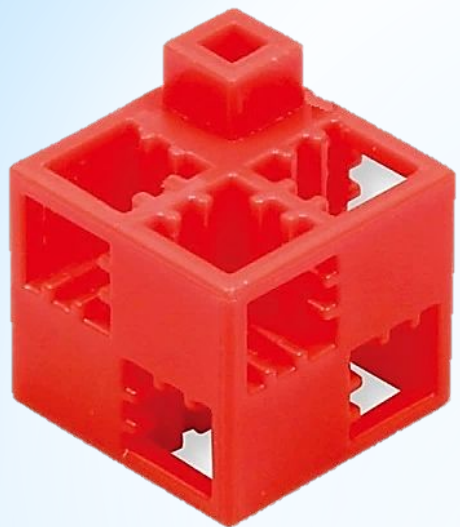



Горизонтальное соединение

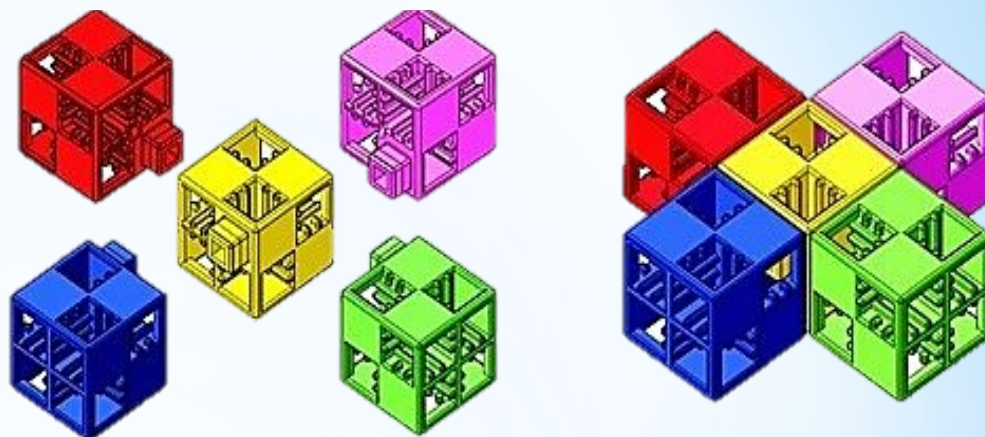

Вертикальное соединение

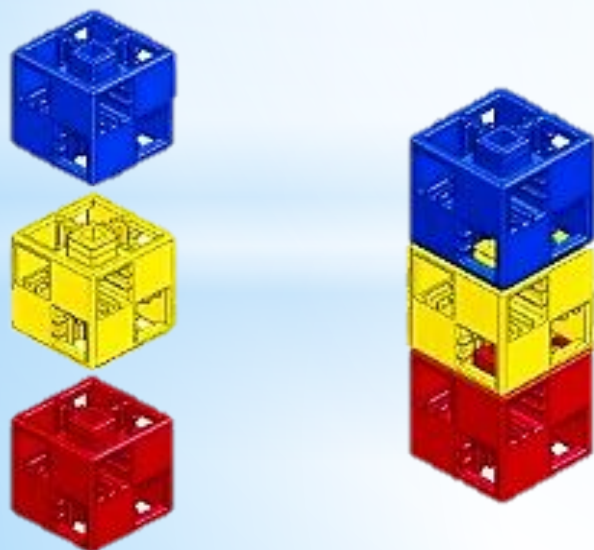

Диагональное соединение

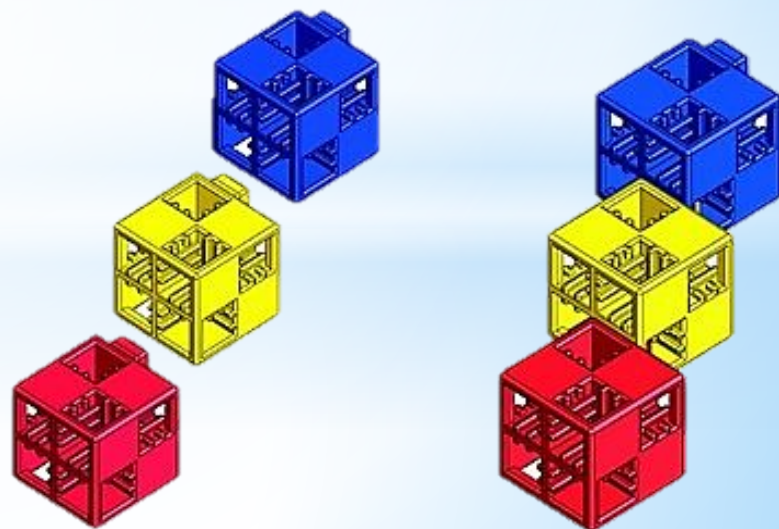

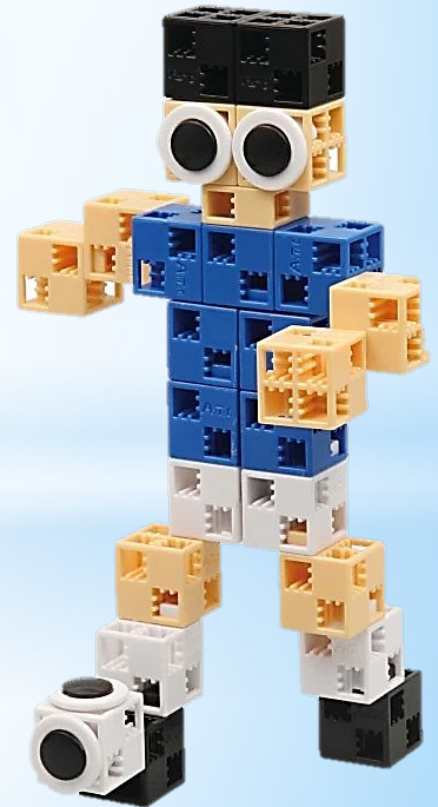
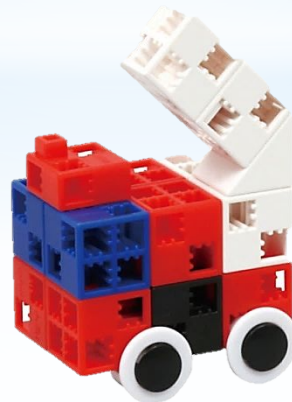
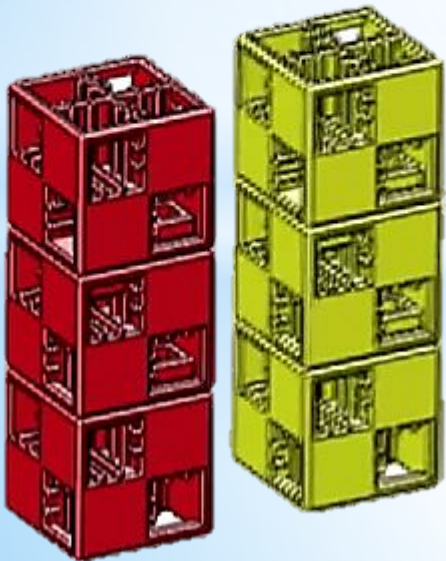
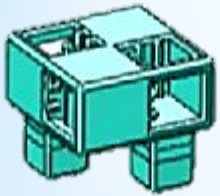
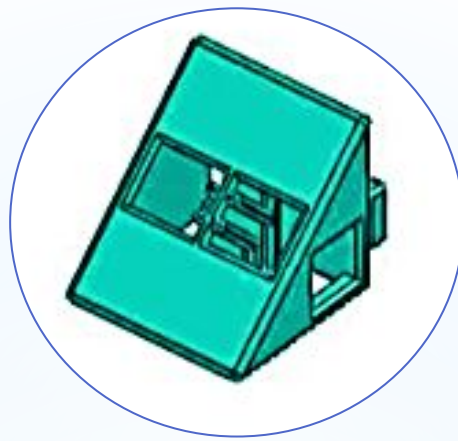
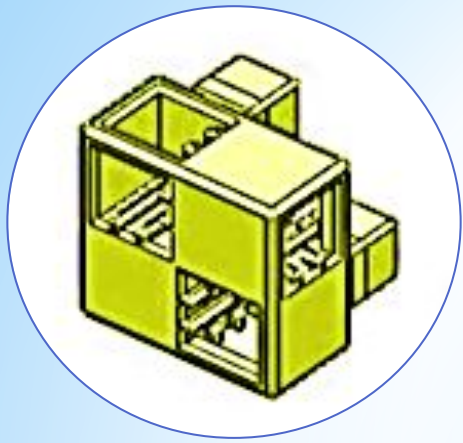

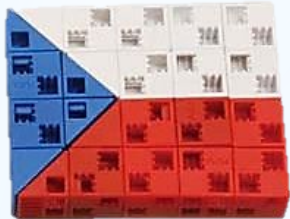
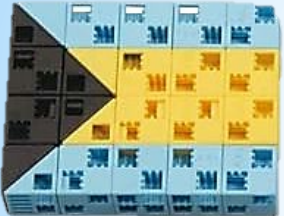

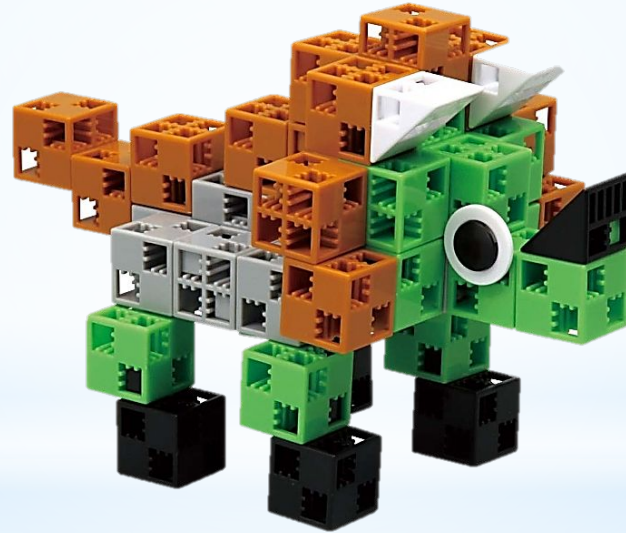
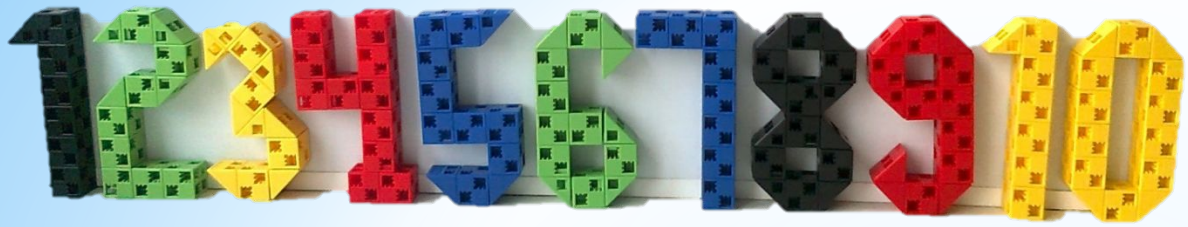

«ТРИМИНО»

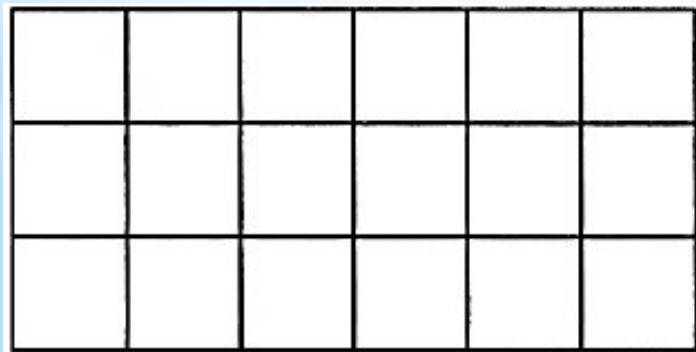
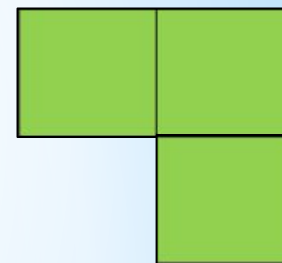
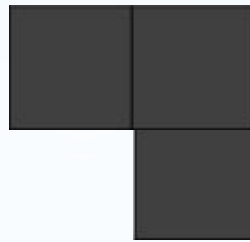
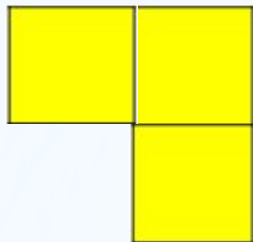
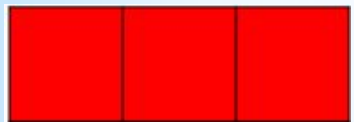
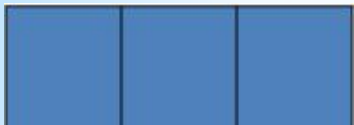

«МИНИ-ТАНГРАМ»

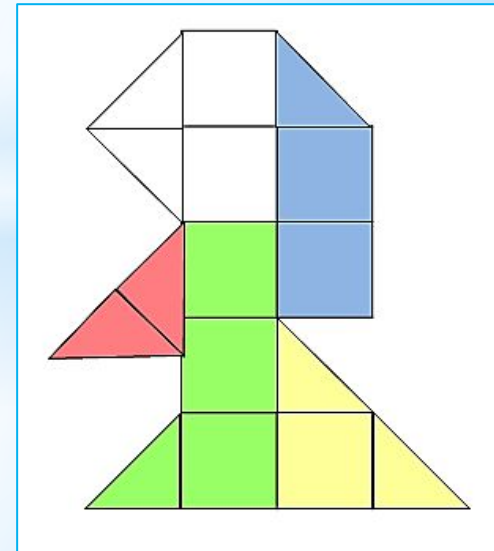
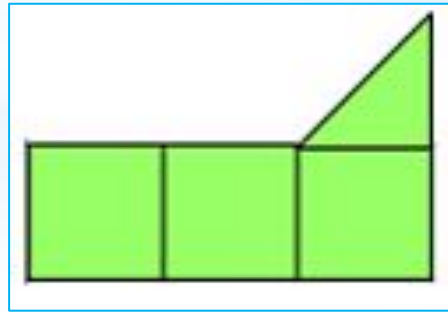
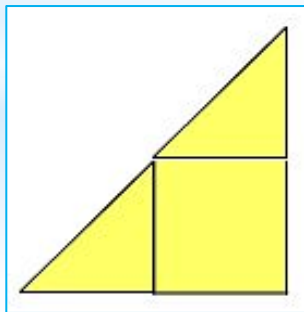
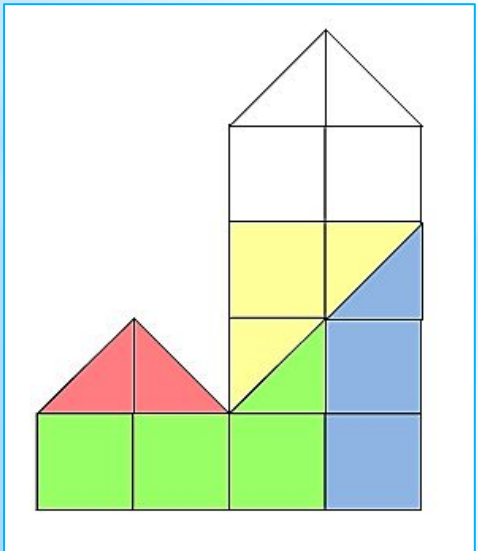
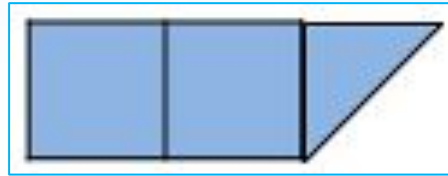
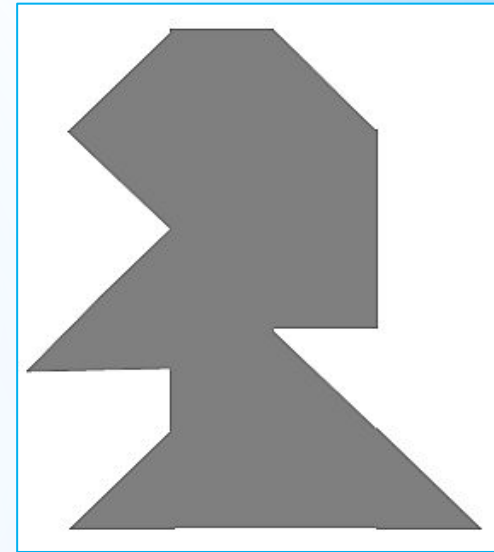
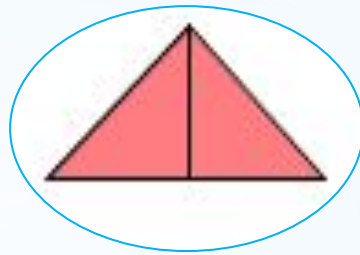
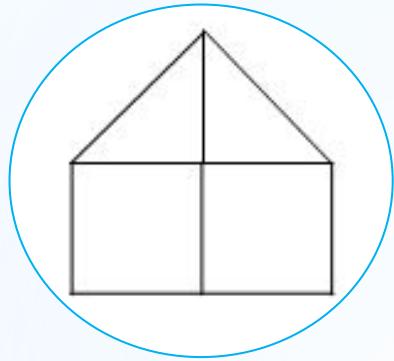
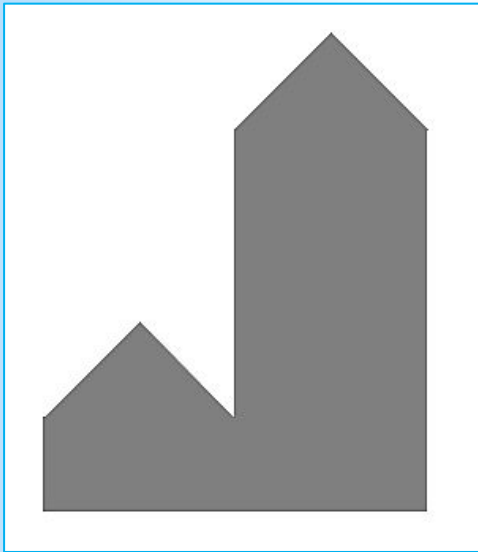

МОЛОДЦЫ!

