

# Геометрия – 7 класс

## Признаки равенства треугольников

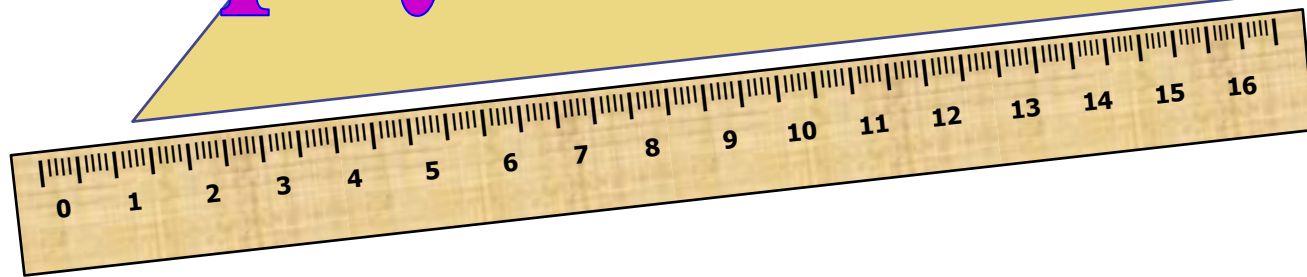

 **ABC**

**A**

**B**

**C**

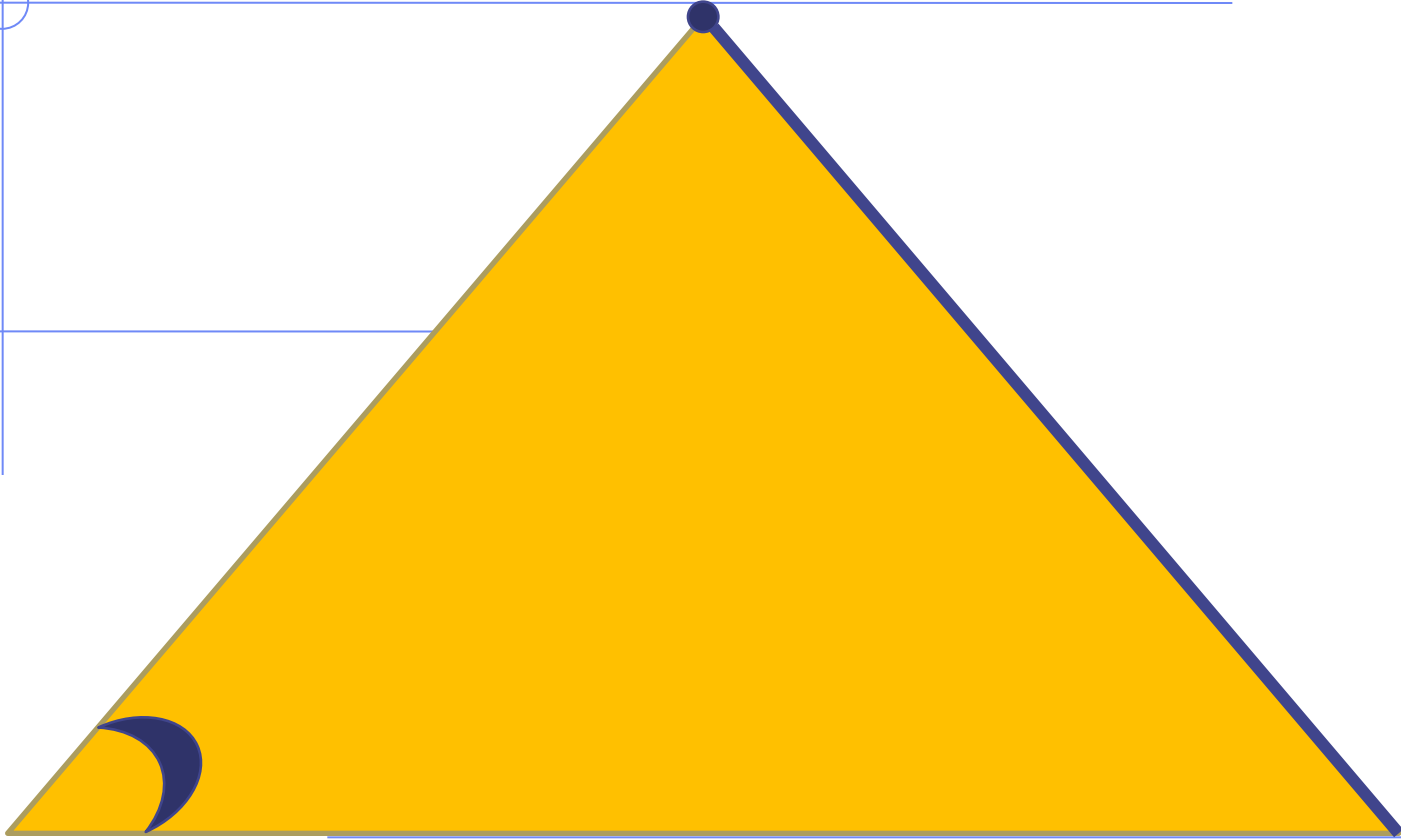

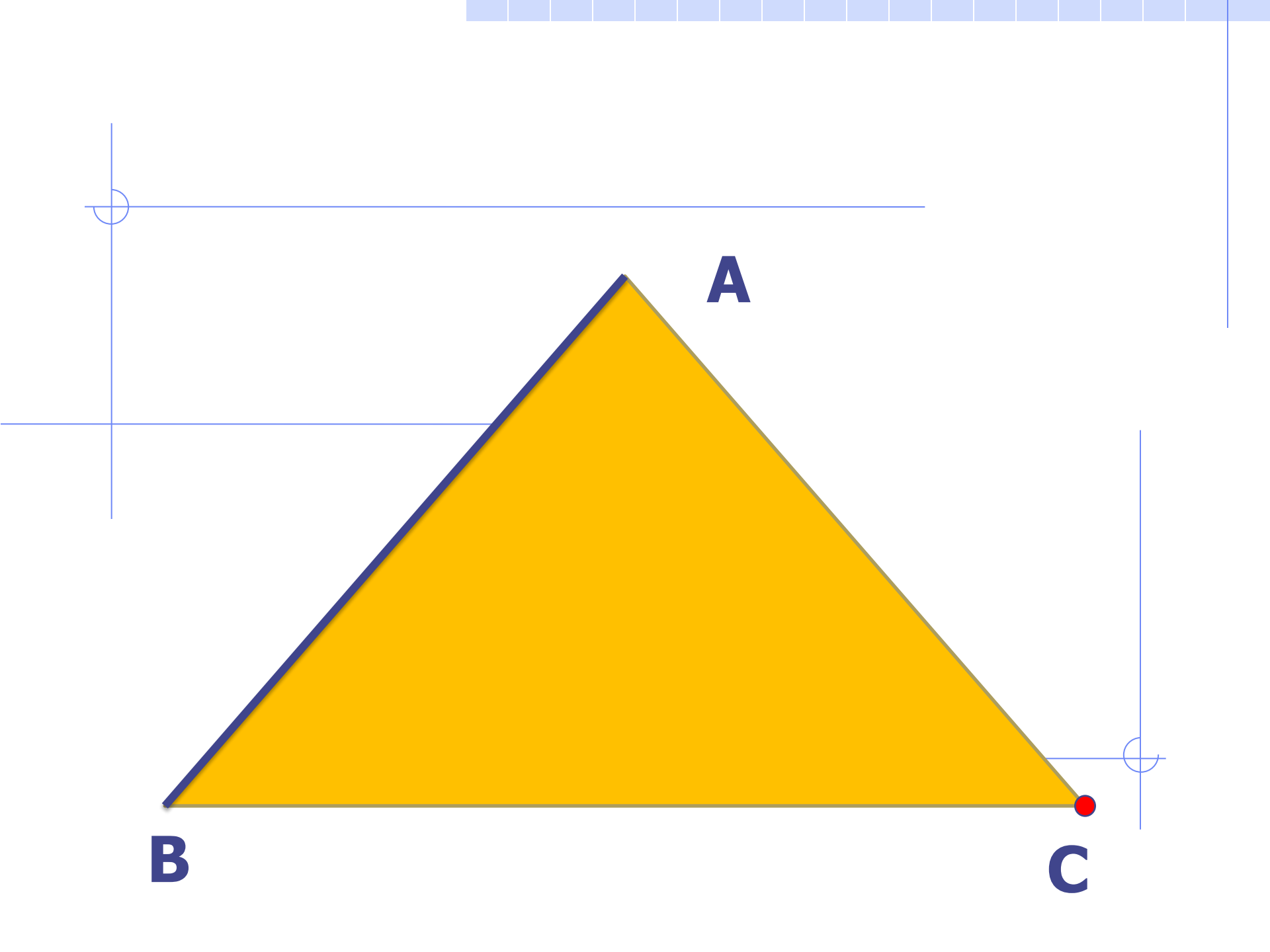

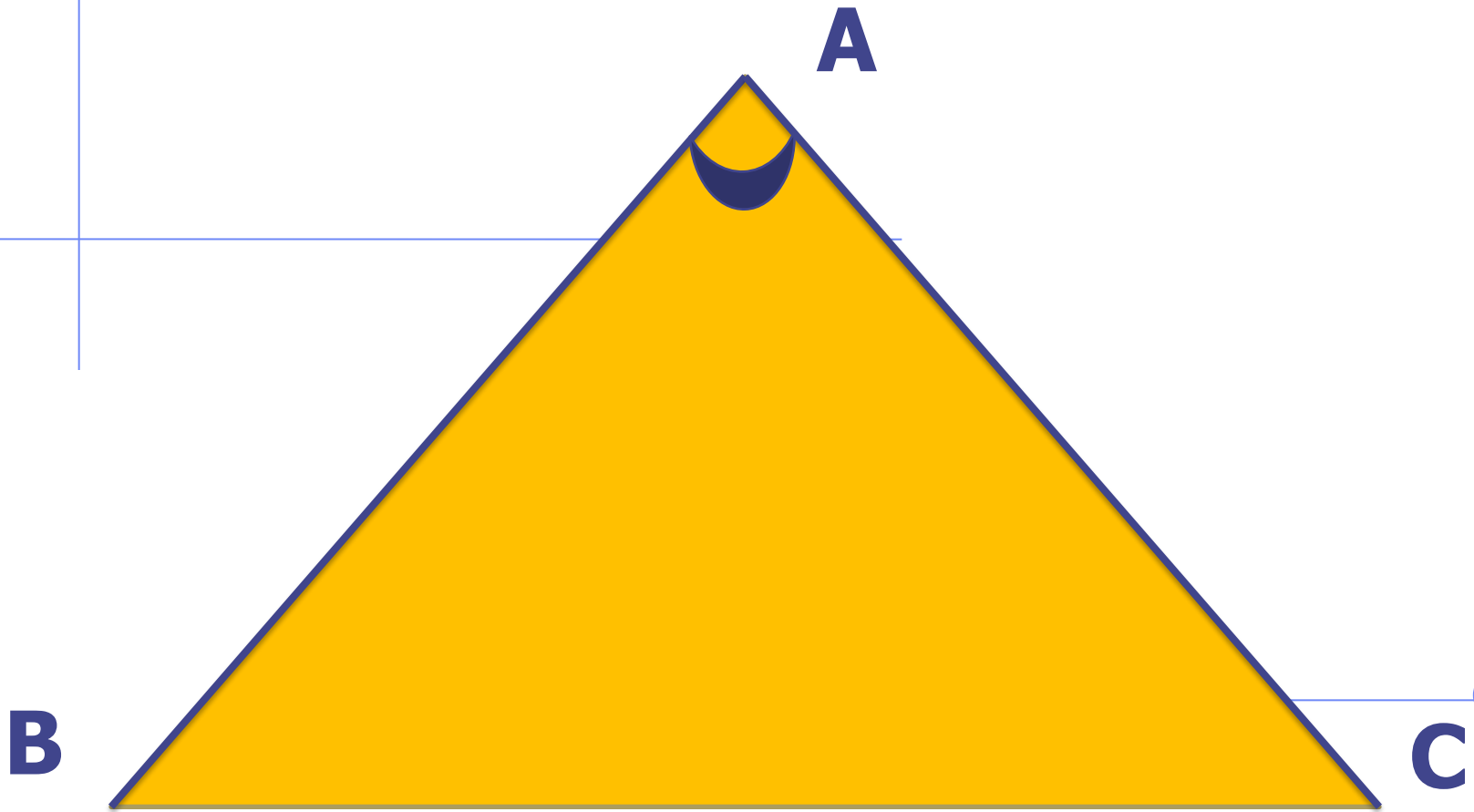

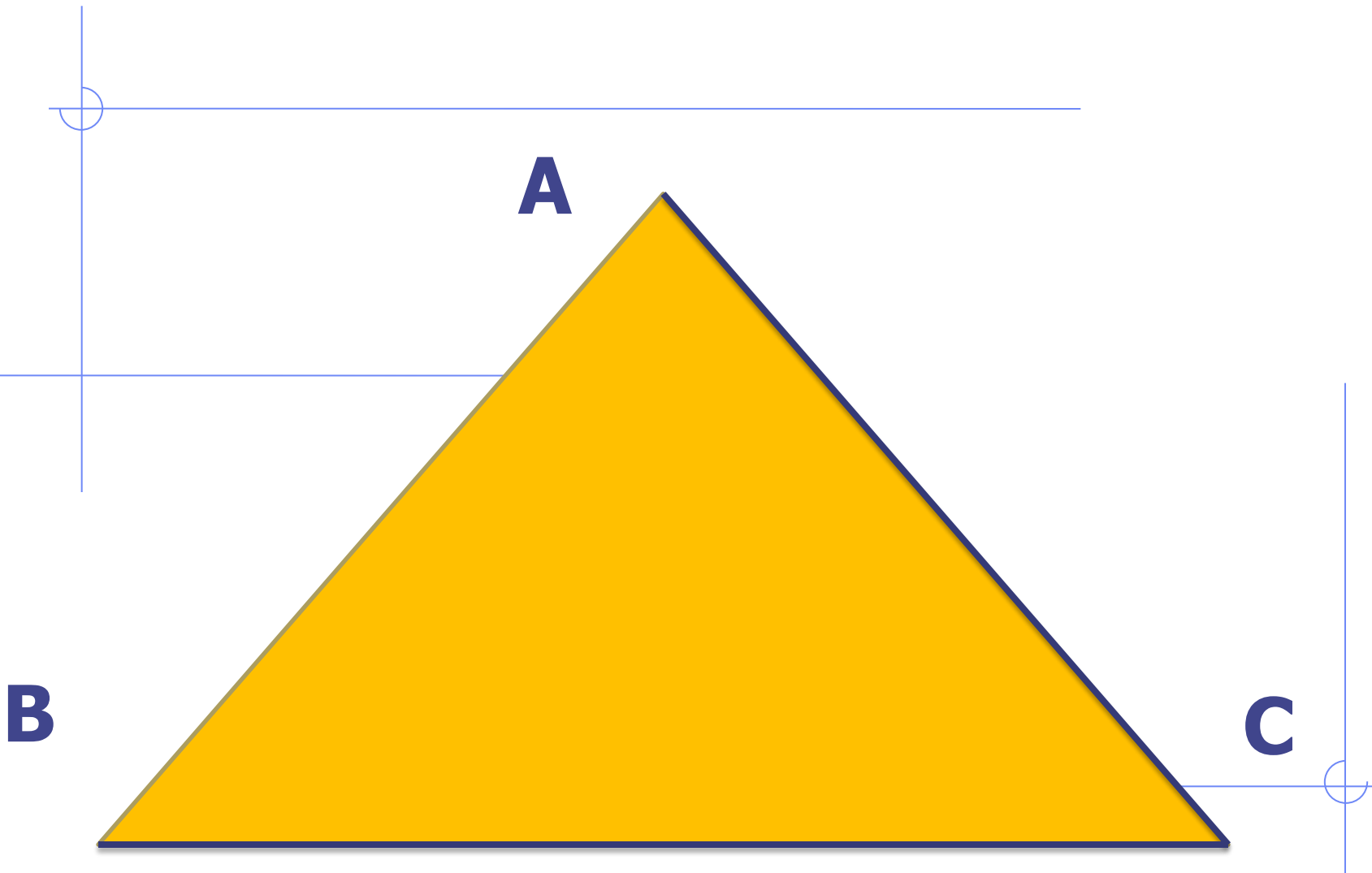

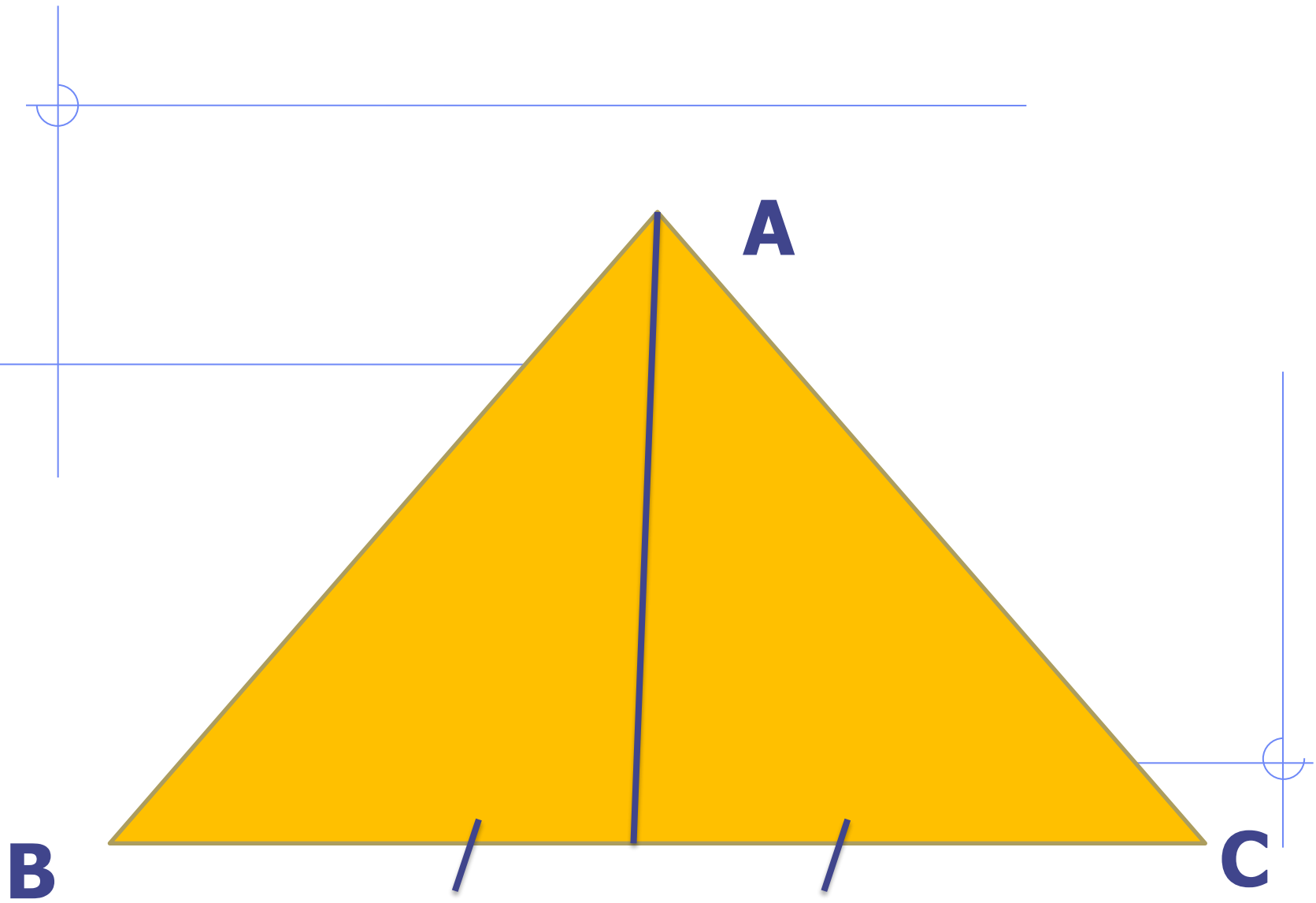

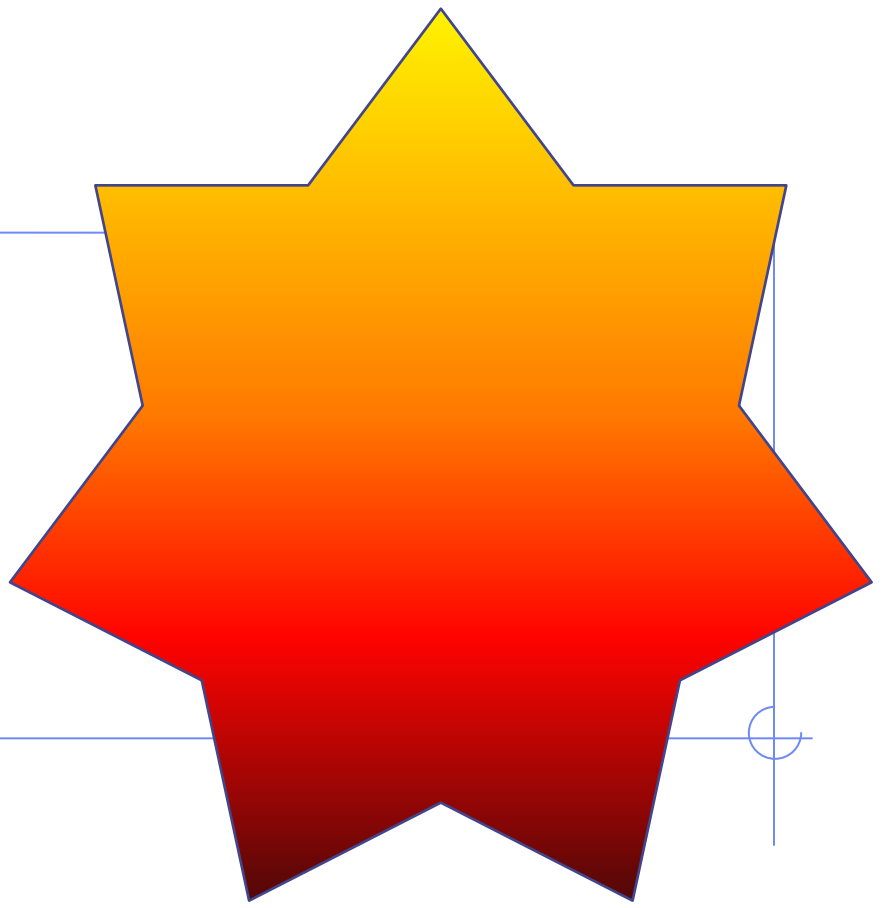
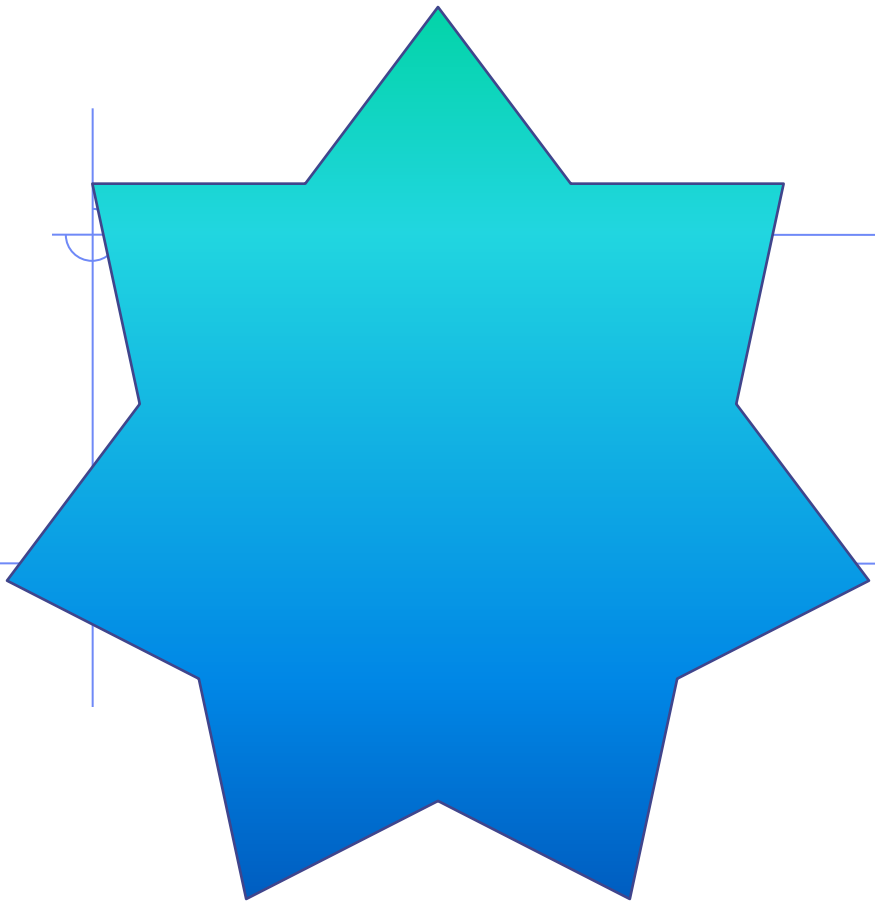

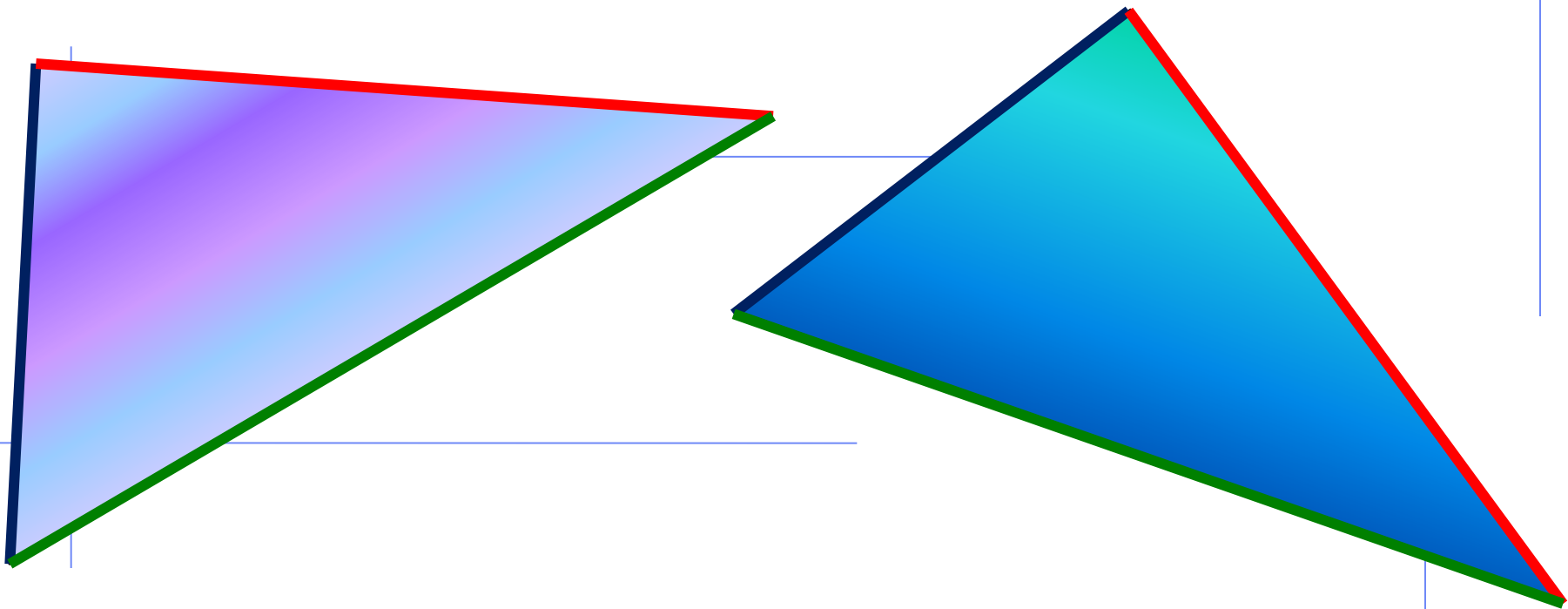



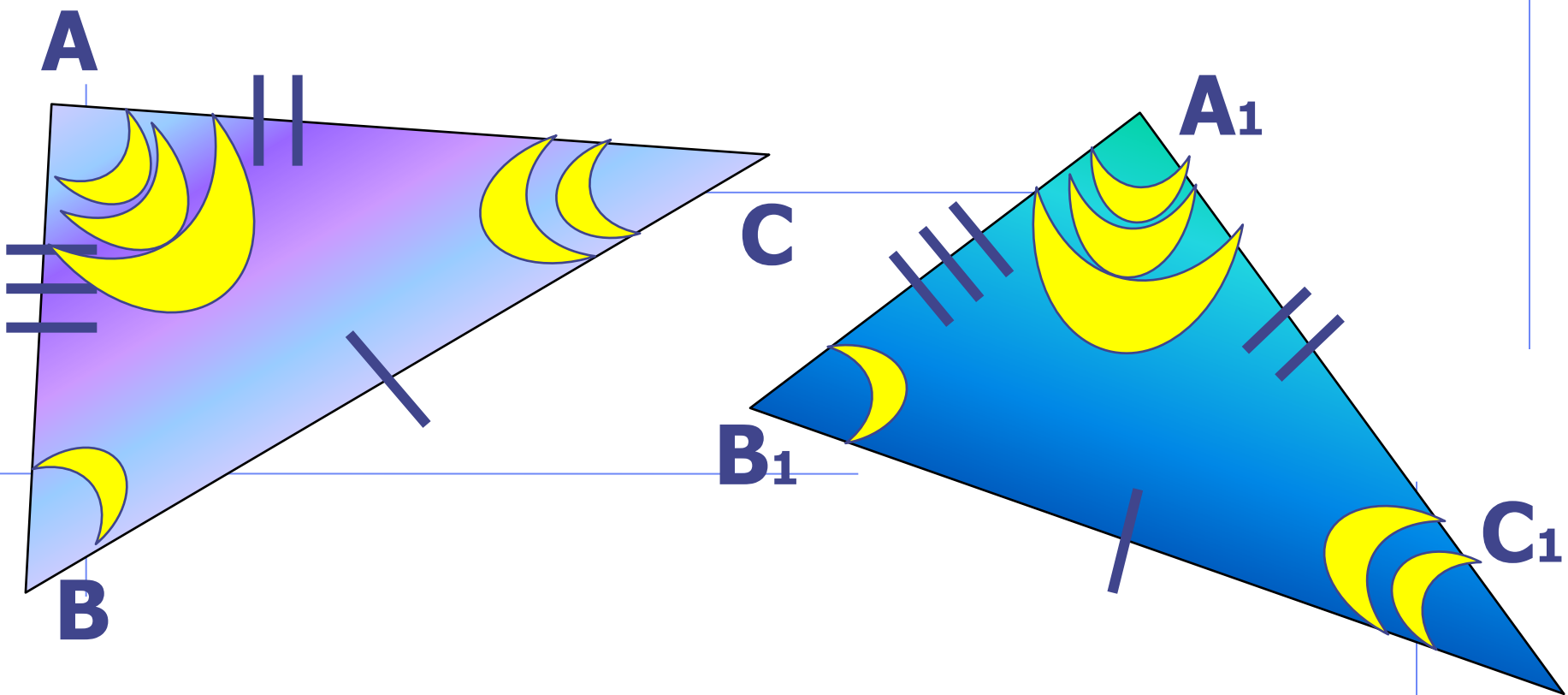

# Геометрия – 7 класс

## Первый признак равенства треугольников

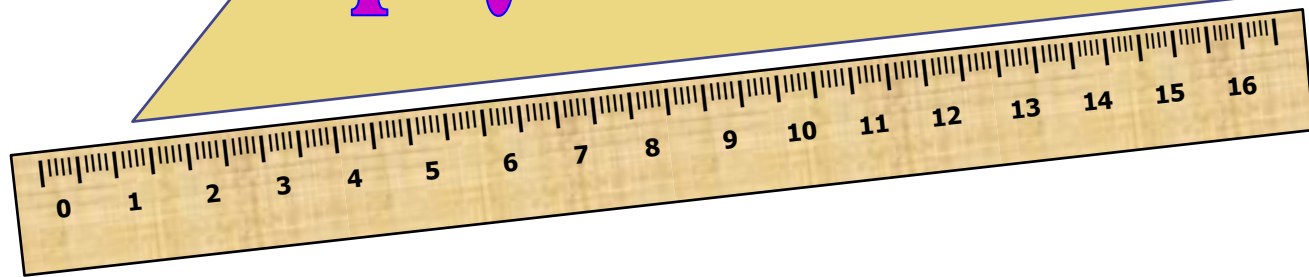

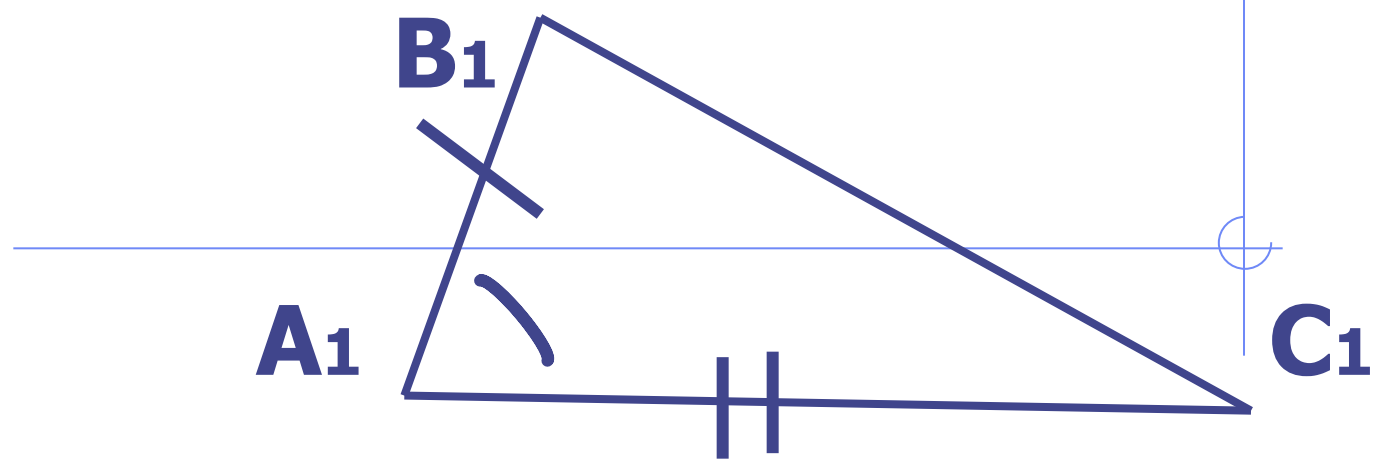
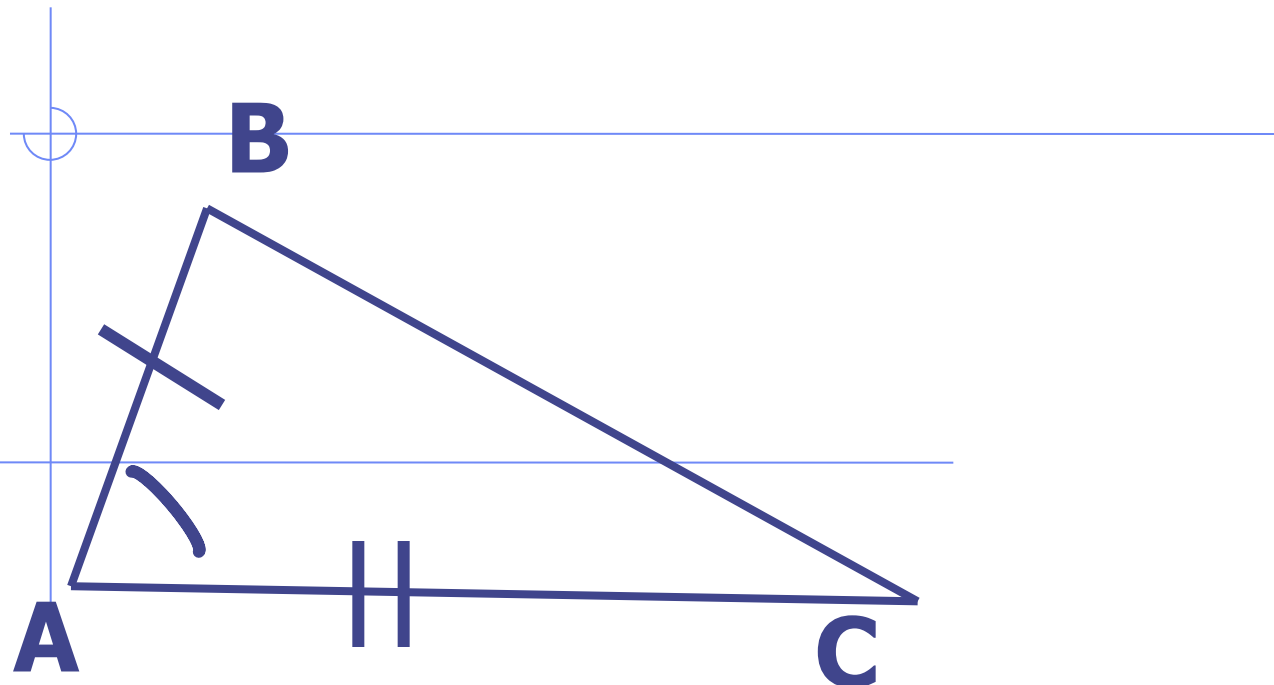

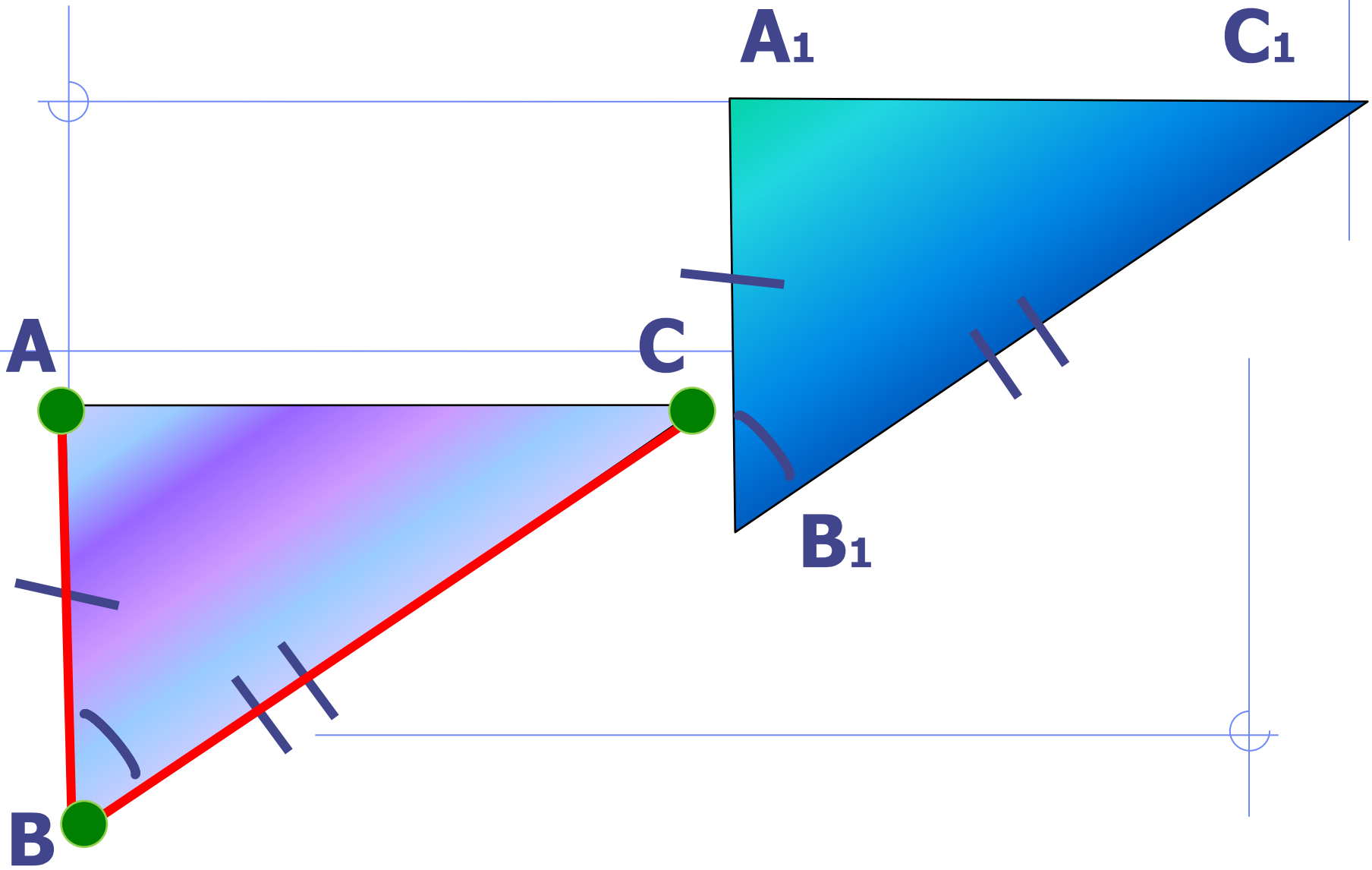

# Геометрия – 7 класс

## Второй признак равенства треугольников

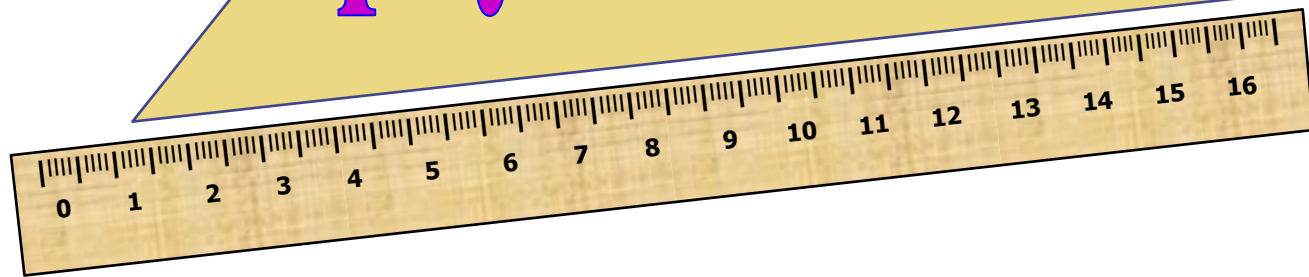

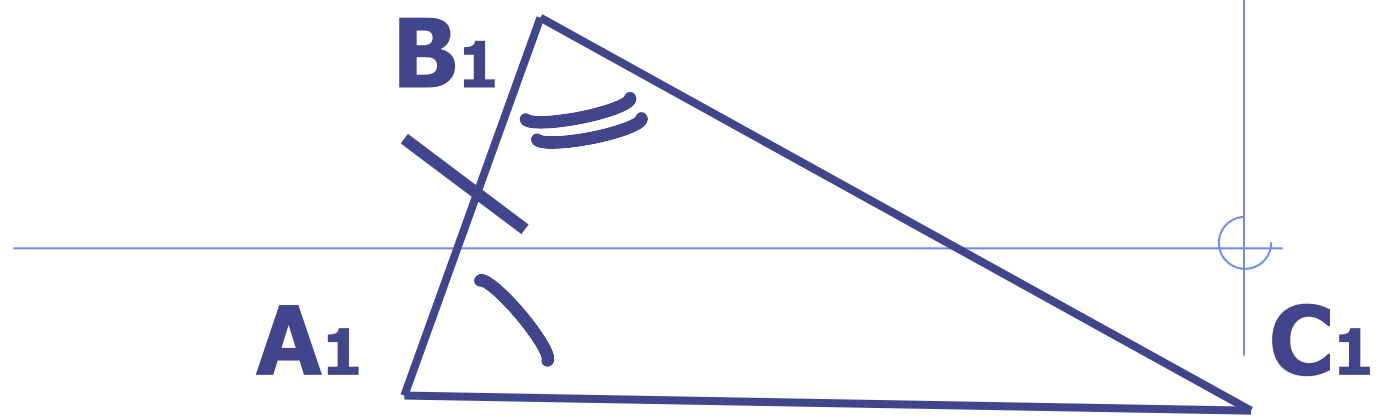
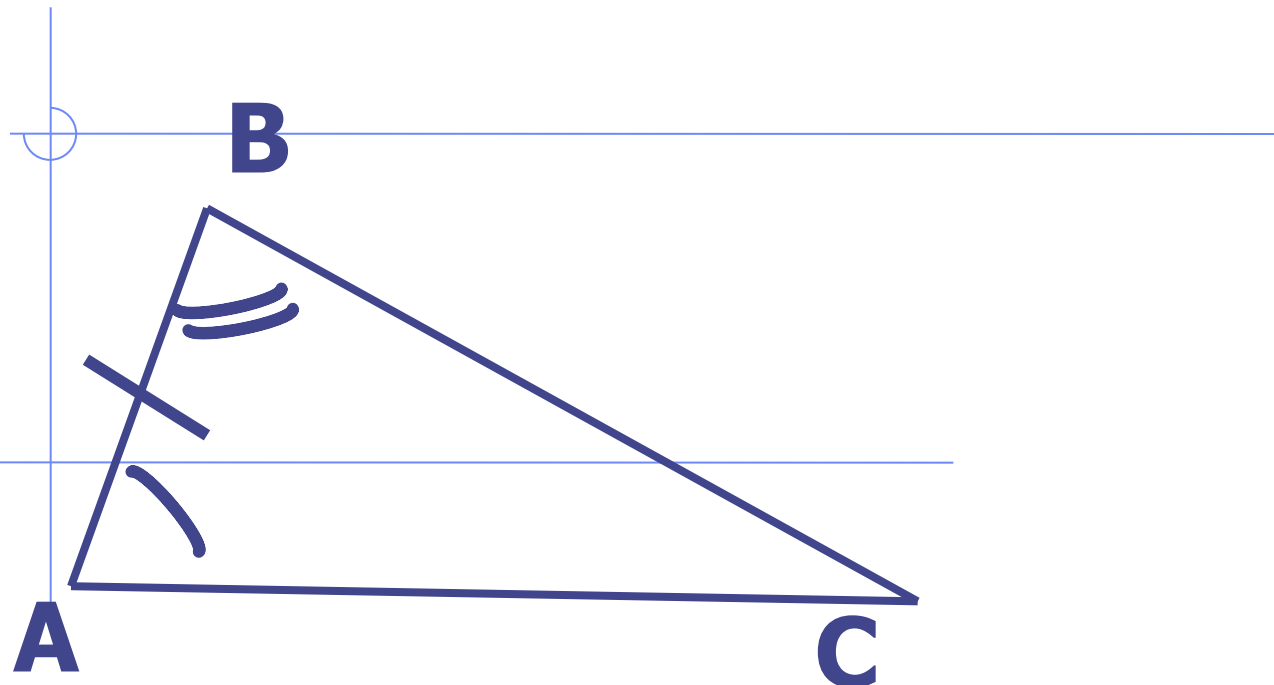

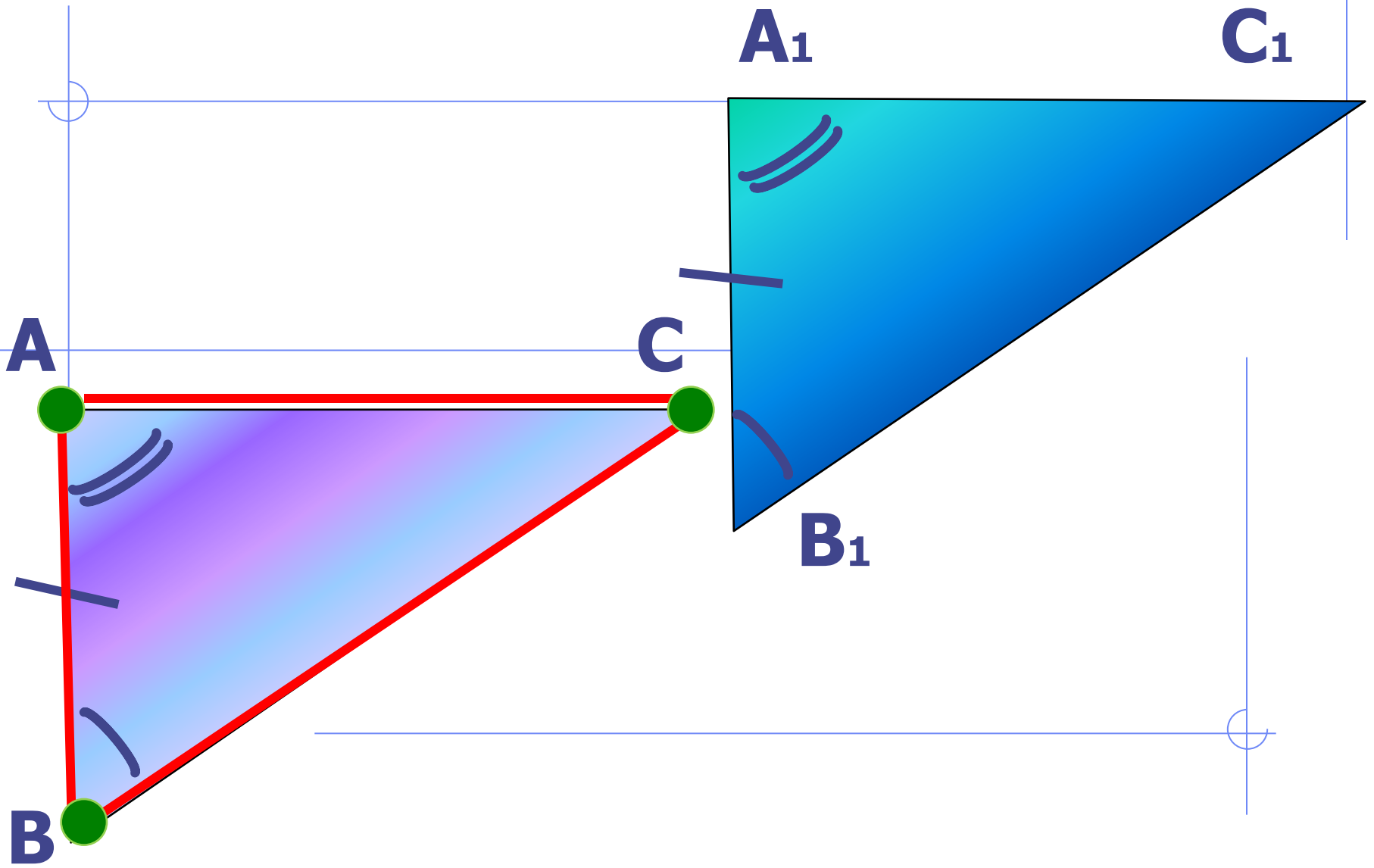

# Геометрия – 7 класс

## Третий признак равенства

## треугольников

