

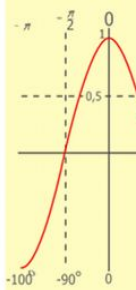

# Наука и образование в 1-й половине XIX века

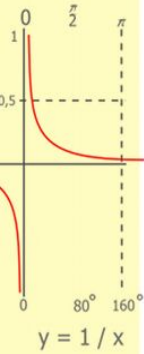

$$\begin{array}{r} 2500 \\ \times 42 \\ \hline 210 \\ + 84 \\ \hline 105000 \end{array}$$

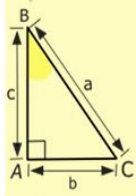
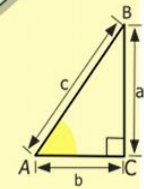

- 2 x 2 = 4
- 3 x 3 = 9
- 4 x 4 = 16
- 5 x 5 = 25
- 6 x 6 = 36
- 7 x 7 = 49
- 8 x 8 = 64
- 9 x 9 = 81

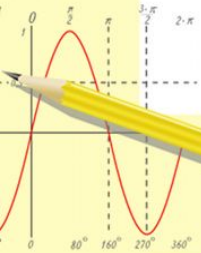

$$\frac{a}{\sin A} = \frac{b}{\sin B} = \frac{c}{\sin C}$$

$$\frac{a}{c} + \frac{b}{c} = \frac{a+b}{c}$$

$$\sin 90^\circ = 1$$



$$\begin{cases} y = \sin 90 \\ x = 25y + 45 \end{cases}$$

$$\begin{cases} y = 1 \\ x = 25 + 45 \\ \hline x = 70 \end{cases}$$

$$(x+y)(x-y) = x^2 - y^2$$

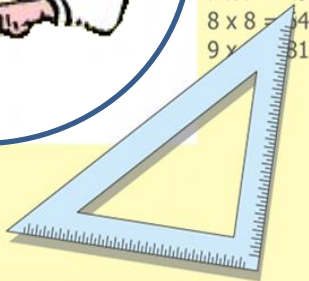

# Общеобразовательные учреждения

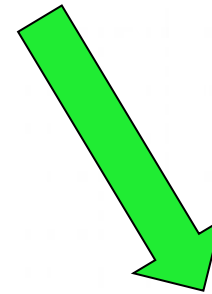
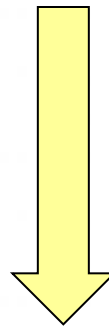
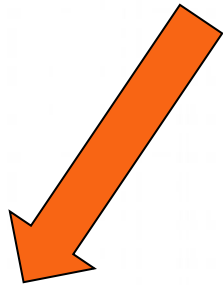

Приходские  
школы

Уездные  
училища

Гимназии

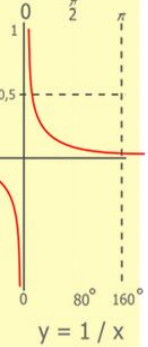
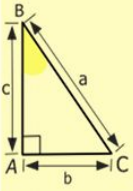
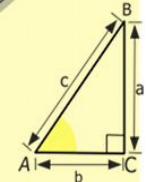
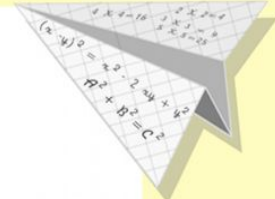
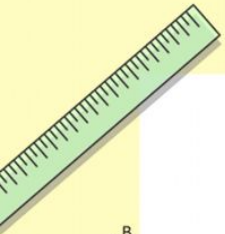

$$\begin{array}{r} 2500 \\ \times 42 \\ \hline 210 \\ + 84 \\ \hline 105000 \end{array}$$

- $2 \times 2 = 4$
- $3 \times 3 = 9$
- $4 \times 4 = 16$
- $5 \times 5 = 25$
- $6 \times 6 = 36$
- $7 \times 7 = 49$
- $8 \times 8 = 64$
- $9 \times 9 = 81$



$$\frac{a}{\sin A} = \frac{b}{\sin B} = \frac{c}{\sin C}$$

$$\frac{a}{c} + \frac{b}{c} = \frac{a+b}{c}$$

$$\sin 90^\circ = 1$$



$$\begin{cases} y = \sin 90 \\ x = 25y + 45 \end{cases}$$

$$\begin{cases} y = 1 \\ x = 25 + 45 \\ \hline x = 70 \end{cases}$$

$$(x+y)(x-y) = x^2 - y^2$$

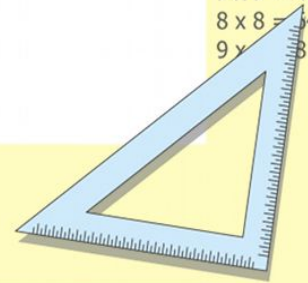

# Предметы:

- 1) география; 2) Закон Божий;
- 3) математика; 4) арифметика; 5) история;
- 6) музыка; 7) грамота;
- 8) гимнастика; 9) физика; 10) биология;
- 11) иностранные языки; 12) геометрия

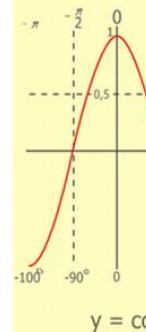
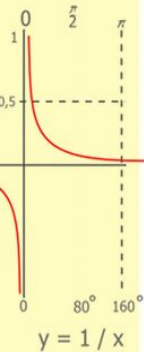
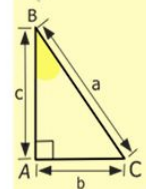
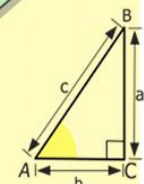
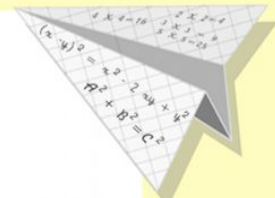
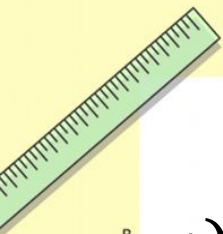

$$\begin{array}{r} 1 \\ \times 42 \\ \hline 210 \\ + 84 \\ \hline 10500 \end{array}$$

$$\begin{array}{l} 2 \times 2 = 4 \\ 3 \times 3 = 9 \\ 4 \times 4 = 16 \\ 5 \times 5 = 25 \\ 6 \times 6 = 36 \\ 7 \times 7 = 49 \\ 8 \times 8 = 64 \\ 9 \times 9 = 81 \end{array}$$



$$\frac{a}{\sin A} = \frac{b}{\sin B} = \frac{c}{\sin C}$$

$$\frac{a}{c} + \frac{b}{c} = \frac{a+b}{c}$$

$$\sin 90^\circ = 1$$



$$\begin{cases} y = \sin 90 \\ x = 25y + 45 \end{cases}$$

$$\begin{cases} y = 1 \\ x = 25 + 45 \\ \hline x = 70 \end{cases}$$

$$(x+y)(x-y) = x^2 - y^2$$

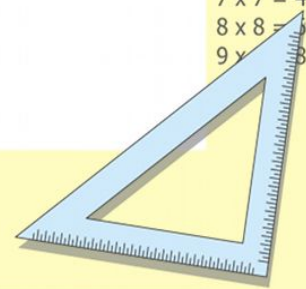

# Расписание уроков. XIX век.

1. Арифметика

2. Закон Божий

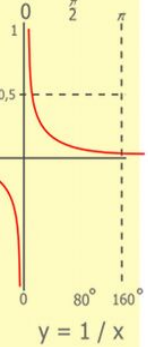
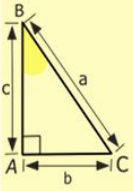
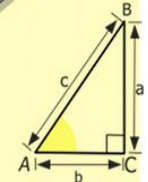
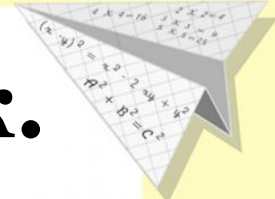
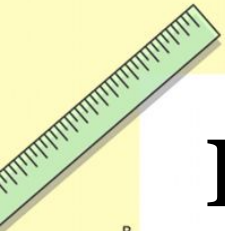

$$\begin{array}{r} 1 \\ 2500 \\ \times 42 \\ \hline 210 \\ + 84 \\ \hline 105000 \end{array}$$

$$\begin{array}{l} 2 \times 2 = 4 \\ 3 \times 3 = 9 \\ 4 \times 4 = 16 \\ 5 \times 5 = 25 \\ 6 \times 6 = 36 \\ 7 \times 7 = 49 \\ 8 \times 8 = 64 \\ 9 \times 9 = 81 \end{array}$$

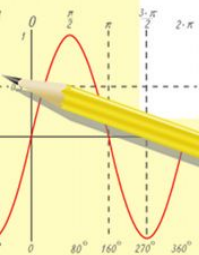

$$\frac{a}{\sin A} = \frac{b}{\sin B} = \frac{c}{\sin C}$$

$$\frac{a}{c} + \frac{b}{c} = \frac{a+b}{c}$$

$$\sin 90^\circ = 1$$



$$\begin{cases} y = \sin 90 \\ x = 25y + 45 \end{cases}$$

$$\begin{cases} y = 1 \\ x = 25 + 45 \\ \hline x = 70 \end{cases}$$

$$(x+y)(x-y) = x^2 - y^2$$

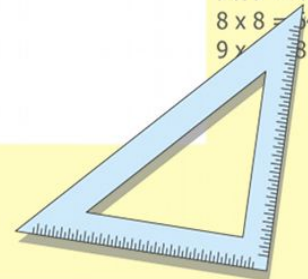

Решите задачу

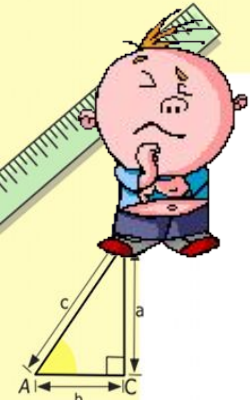

Высота одной стены терема равна трём косым саженьям.

За покраску одной косой сажени берут 2 рубля.

Сколько денег надо заплатить за покраску 4 стен терема?

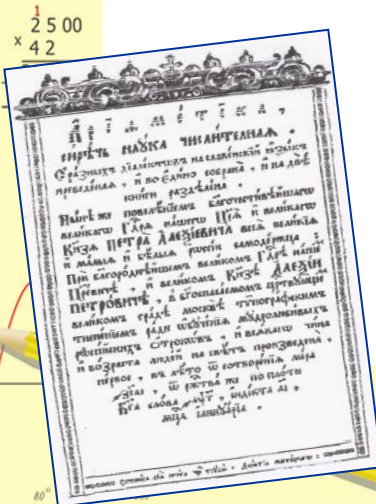
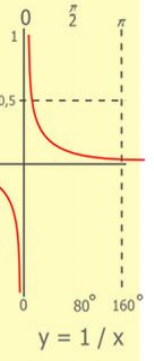
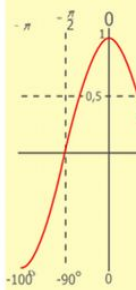
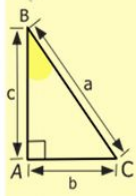

$$\frac{c}{\sin C} \quad \frac{a}{c} + \frac{b}{c} = \frac{a+b}{c}$$

$$\sin 90^\circ = 1$$



$$\begin{cases} y = \sin 90 \\ x = 25y + 45 \end{cases}$$

$$\begin{cases} y = 1 \\ x = 25 + 45 \end{cases}$$

$$x = 70$$

$$(x+y)(x-y) = x^2 - y^2$$

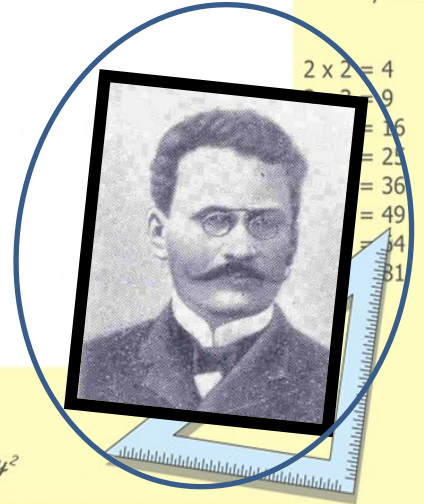

- 2 x 2 = 4
- 3 x 3 = 9
- 4 x 4 = 16
- 5 x 5 = 25
- 6 x 6 = 36
- 7 x 7 = 49
- 8 x 8 = 64
- 9 x 9 = 81

# Идёт урок.

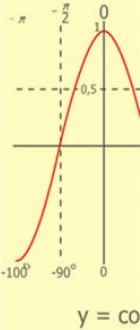
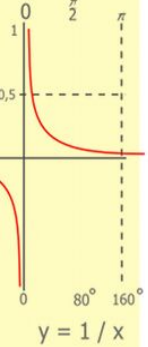
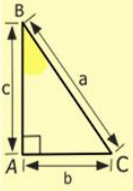
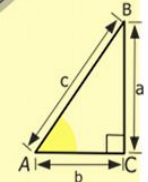
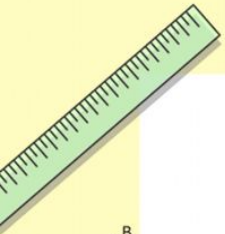

$$\begin{array}{r} 1 \\ 2500 \\ \times 42 \\ \hline 210 \\ + 84 \\ \hline 10500 \end{array}$$

- $2 \times 2 = 4$
- $3 \times 3 = 9$
- $4 \times 4 = 16$
- $5 \times 5 = 25$
- $6 \times 6 = 36$
- $7 \times 7 = 49$
- $8 \times 8 = 64$
- $9 \times 9 = 81$



$$\frac{a}{\sin A} = \frac{b}{\sin B} = \frac{c}{\sin C}$$

$$\frac{a}{c} + \frac{b}{c} = \frac{a+b}{c}$$

$$\sin 90^\circ = 1$$



$$\begin{cases} y = \sin 90 \\ x = 25y + 45 \end{cases}$$

$$\begin{cases} y = 1 \\ x = 25 + 45 \\ \hline x = 70 \end{cases}$$

$$(x+y)(x-y) = x^2 - y^2$$

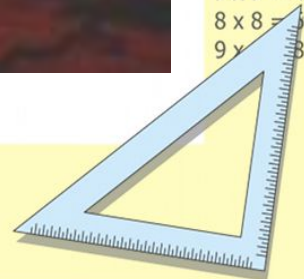

«Казни сына своего от юности, и покоит тя на старость твою, и даст красоту душе твоей, и не ослабляй, бия младенца: аще бо жезлом биеша его, не умрет, но здравие будет; ты бия его по телу, а душу его избавляеши от смерти.

Дщерь ли имаша: положи на них грозу свою, соблюдеши я от телесных: да не посрамиши лица своего, да в послушании ходит, аще бо отдаси дщерь свою без порока, то яко велико дело совершиши и посреди собора похвалишися, при концы не постонеси на ню».

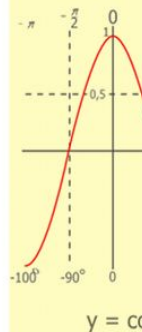
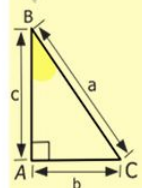
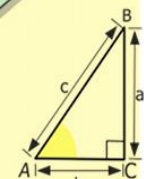
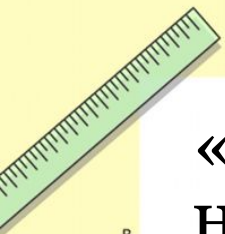

$$\begin{array}{r} 2500 \\ \times 42 \\ \hline 2100 \\ + 8400 \\ \hline 105000 \end{array}$$

- 2 x 2 = 4
- 3 x 3 = 9
- 4 x 4 = 16
- 5 x 5 = 25
- 6 x 6 = 36
- 7 x 7 = 49
- 8 x 8 = 64
- 9 x 9 = 81



$$\frac{a}{\sin A} = \frac{b}{\sin B} = \frac{c}{\sin C}$$

$$\frac{a}{c} + \frac{b}{c} = \frac{a+b}{c}$$

$$\sin 90^\circ = 1$$



$$\begin{cases} y = \sin 90 \\ x = 25y + 45 \end{cases}$$

$$\begin{cases} y = 1 \\ x = 25 + 45 \\ \hline x = 70 \end{cases}$$

$$(x+y)(x-y) = x^2 - y^2$$

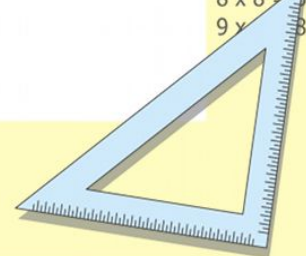



**Н.И.Лобачевский**



**К.М.Бэр.**

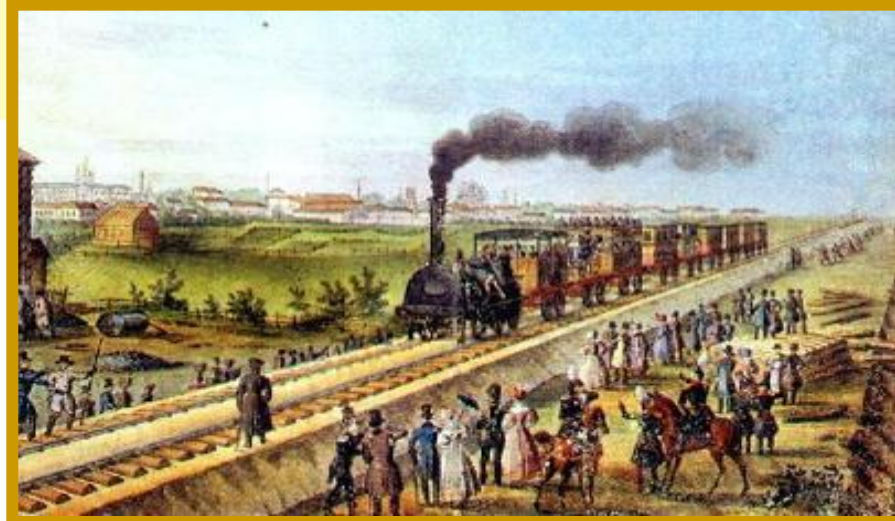

**Н.Н.Зинин**

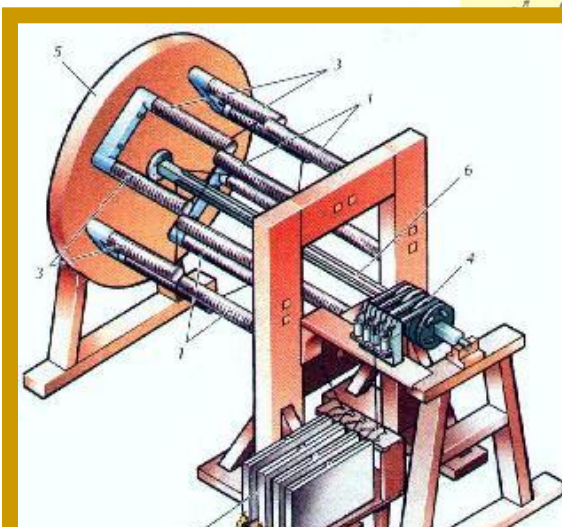

**Электрический  
двигатель  
Б.С.Якоби**

$$\frac{c}{n \cdot c} \quad \frac{a}{c} + \frac{b}{c} = \frac{a+b}{c}$$

$$\begin{aligned} 90 \\ + 45 \\ \hline x = 25 + 45 \\ x = 70 \end{aligned}$$



# Найди ошибки

При Николае II сохранились все типы школ. В церковно-приходских школах изучали: Закон Божий, арифметику и грамоту. Число высших учебных заведений резко сократилось. Правительство уделяло внимание развитию науки. Крупнейшие предприниматели России вкладывали деньги в развитие зарубежной науки.

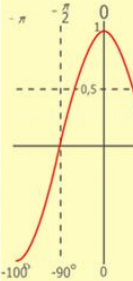
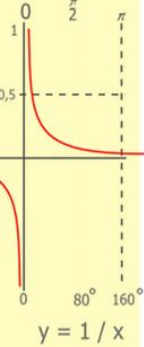
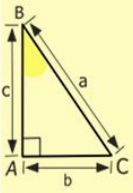
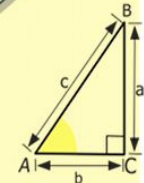
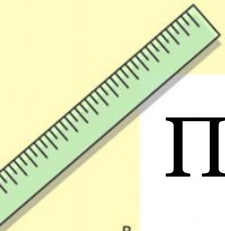

$$\begin{array}{r} 2500 \\ \times 42 \\ \hline 2100 \\ + 8400 \\ \hline 105000 \end{array}$$

- $2 \times 2 = 4$
- $3 \times 3 = 9$
- $4 \times 4 = 16$
- $5 \times 5 = 25$
- $6 \times 6 = 36$
- $7 \times 7 = 49$
- $8 \times 8 = 64$
- $9 \times 9 = 81$



$$\frac{a}{\sin A} = \frac{b}{\sin B} = \frac{c}{\sin C}$$

$$\frac{a}{c} + \frac{b}{c} = \frac{a+b}{c}$$

$$\sin 90^\circ = 1$$



$$\begin{cases} y = \sin 90 \\ x = 25y + 45 \end{cases}$$

$$\begin{cases} y = 1 \\ x = 25 + 45 \end{cases}$$

$$x = 70$$

$$(x+y)(x-y) = x^2 - y^2$$

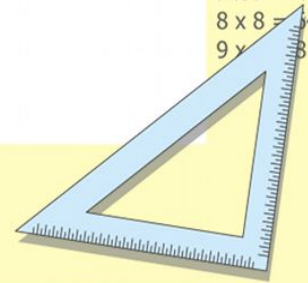

# Рефлексивный анализ урока.

Сегодня на занятии :

- Я узнал(а).....
- Было интересно.....
- Было трудно.....
- Самооценка работы на уроке (по пятибальной системе).....

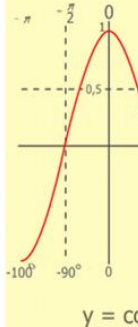
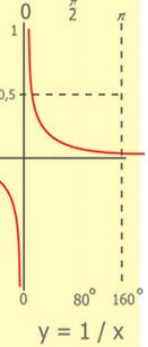
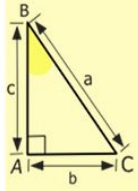
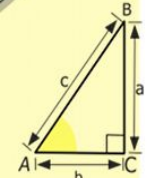
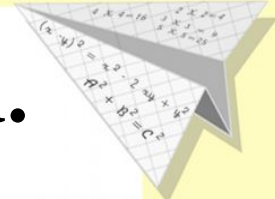

$$\begin{array}{r} 1 \\ 2500 \\ \times 42 \\ \hline 210 \\ + 84 \\ \hline 105000 \end{array}$$

$$\begin{array}{l} 2 \times 2 = 4 \\ 3 \times 3 = 9 \\ 4 \times 4 = 16 \\ 5 \times 5 = 25 \\ 6 \times 6 = 36 \\ 7 \times 7 = 49 \\ 8 \times 8 = 64 \\ 9 \times 9 = 81 \end{array}$$

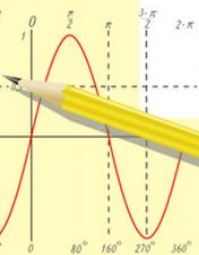

$$\frac{a}{\sin A} = \frac{b}{\sin B} = \frac{c}{\sin C}$$

$$\frac{a}{c} + \frac{b}{c} = \frac{a+b}{c}$$

$$\sin 90^\circ = 1$$



$$\begin{cases} y = \sin 90 \\ x = 25y + 45 \end{cases}$$

$$\begin{cases} y = 1 \\ x = 25 + 45 \\ \hline x = 70 \end{cases}$$

$$(x+y)(x-y) = x^2 - y^2$$

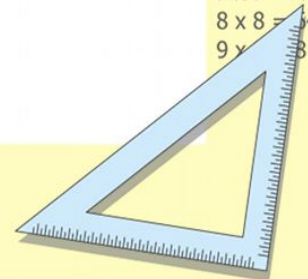



# Наука и образование в 1-й половине XIX века

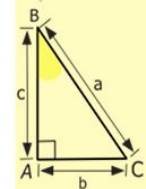
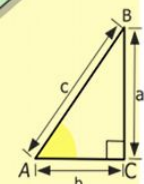

$$\begin{array}{r} 2500 \\ \times 42 \\ \hline 2100 \\ + 840 \\ \hline 105000 \end{array}$$



- 2 x 2 = 4
- 3 x 3 = 9
- 4 x 4 = 16
- 5 x 5 = 25
- 6 x 6 = 36
- 7 x 7 = 49
- 8 x 8 = 64
- 9 x 9 = 81



$$\frac{a}{\sin A} = \frac{b}{\sin B} = \frac{c}{\sin C}$$

$$\frac{a}{c} + \frac{b}{c} = \frac{a+b}{c}$$

$$\sin 90^\circ = 1$$



$$\begin{cases} y = \sin 90 \\ x = 25y + 45 \end{cases}$$

$$\begin{cases} y = 1 \\ x = 25 + 45 \\ \hline x = 70 \end{cases}$$

$$(x+y)(x-y) = x^2 - y^2$$

