



*Мир вещей*

*Мир людей*

*Окружающий мир*

*Живая природа*

*Неживая природа*

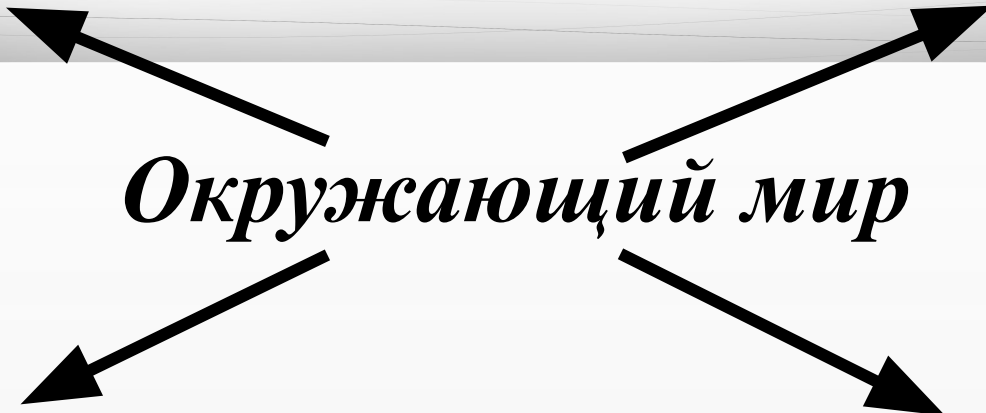

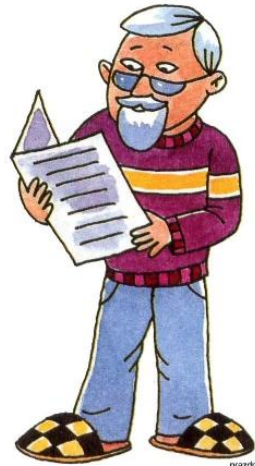

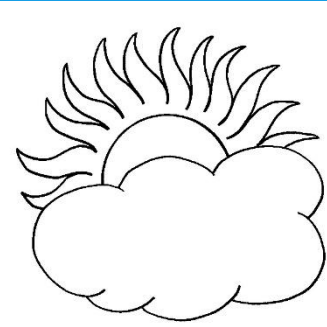
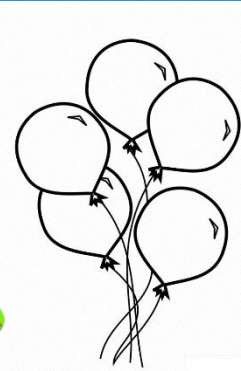
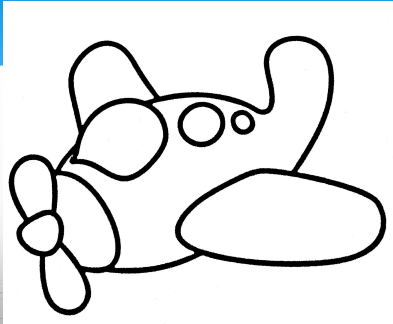



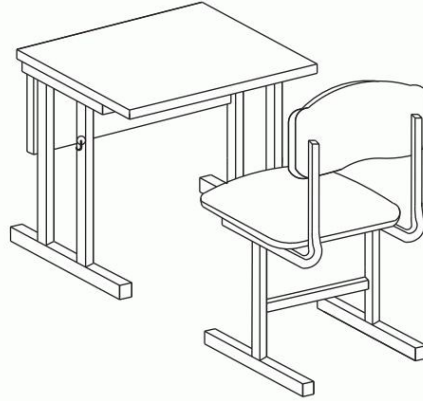
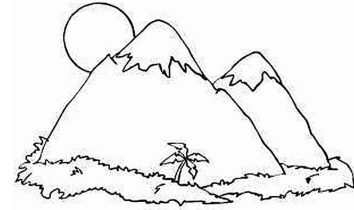

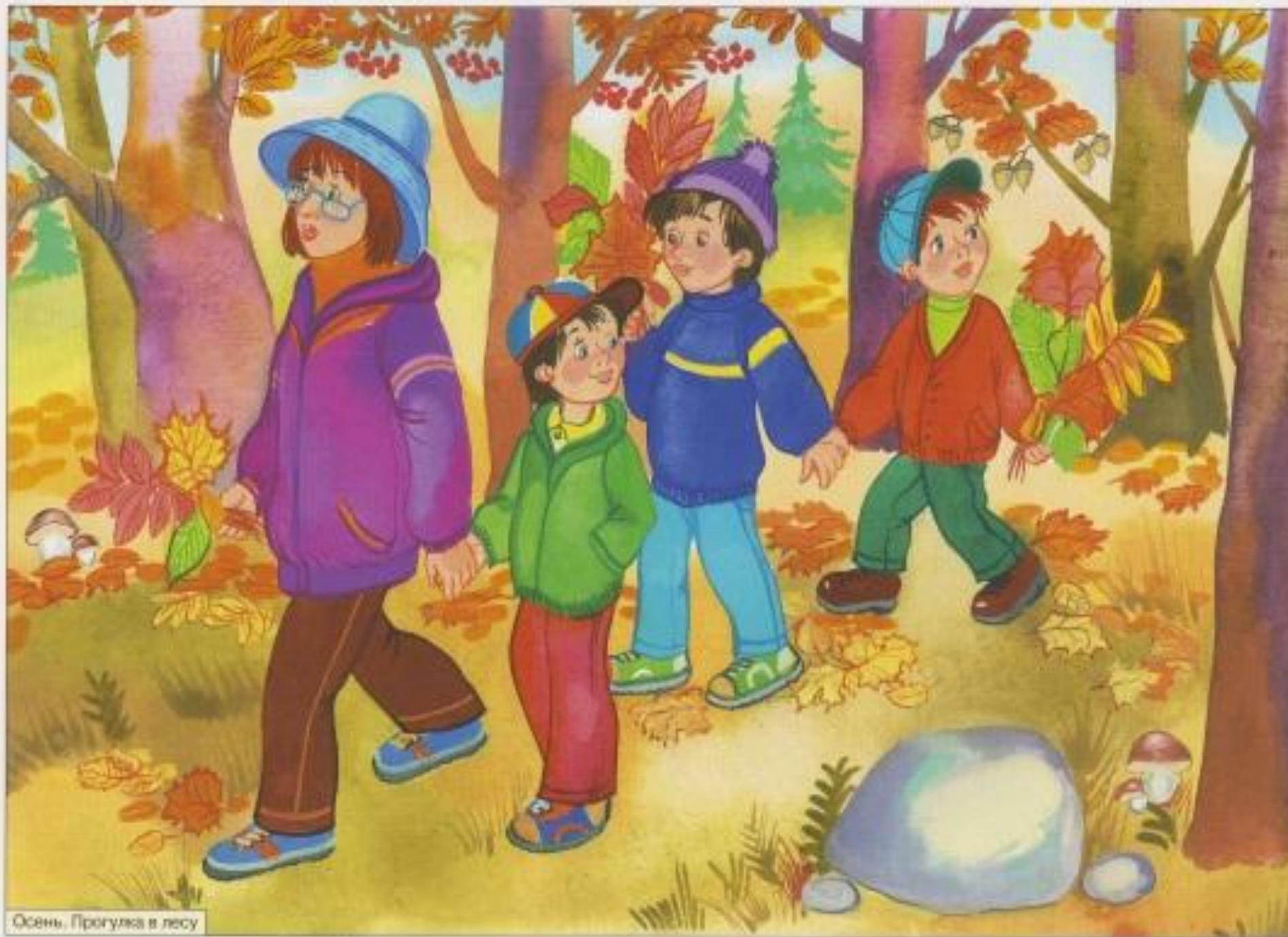

Осень. Прогулка в лесу

**ЧТО НАМ ОСЕНЬ  
ПОДАРИЛА**







5 1 8 3 6 2 4 7

Л И С Т О

П а д

***Сентябрь***

***холоден, да сытен***



«Доскажи словечко».

Листьям время

*опадать*

Птицам время

*улетать*

Грибникам блуждать в

*тумане*

Ветру в трубах

*завывать*

Солнцу

*стынуть*

Тучам –

*литься*

А ребятам всем –

*учиться*





*Что нам*

*осень*

*подарила*

# огород сад





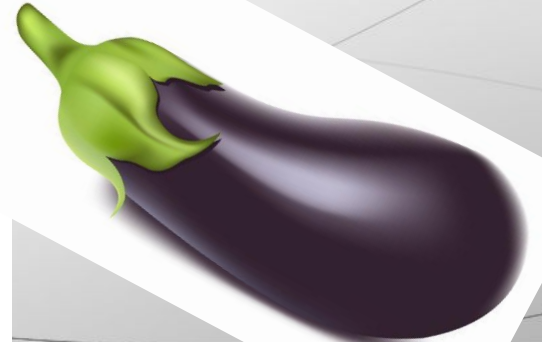

# Назови ласково



ЯБЛОКО



БАНАН



АПЕЛЬСИН



МАНДАРИН



ПЕРСИК



ГРУША



КИВИ



АРБУЗ



ВИНОГРАД



СЛИВА



ЛИМОН



# «Весёлый агроном»

- \* Капудор (Капуста+помидор)
- \* Яблосвёк (Яблоко+свёкла)
- \* Бакларец (Баклажан+огурец)



A scenic autumn landscape featuring a calm pond in the foreground. The water reflects the surrounding trees and foliage, which are in various stages of autumn color, including bright yellows, oranges, and some hints of red. The sky is visible through the branches, appearing bright and slightly overcast. The overall atmosphere is peaceful and serene.

*Спасибо за  
урок!*