



# Морское путешествие

- Кулешова Галина Ивановна
- БМОУ ПСОШ № 1 г. Погар
- Учитель начальных классов





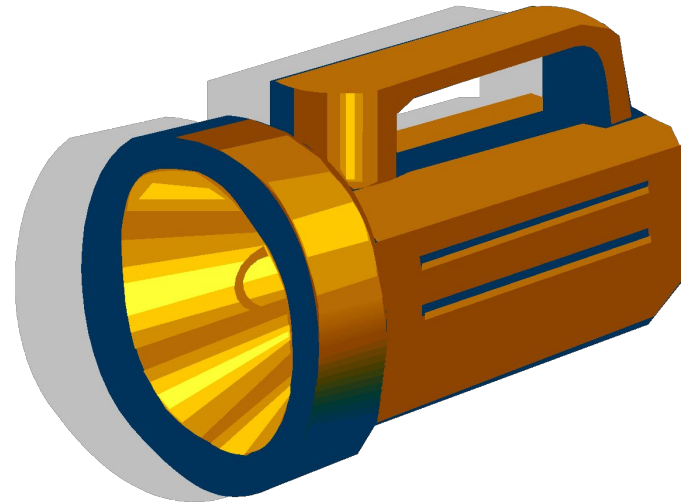
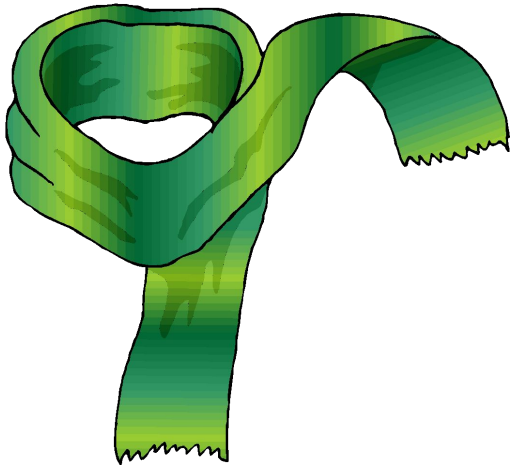



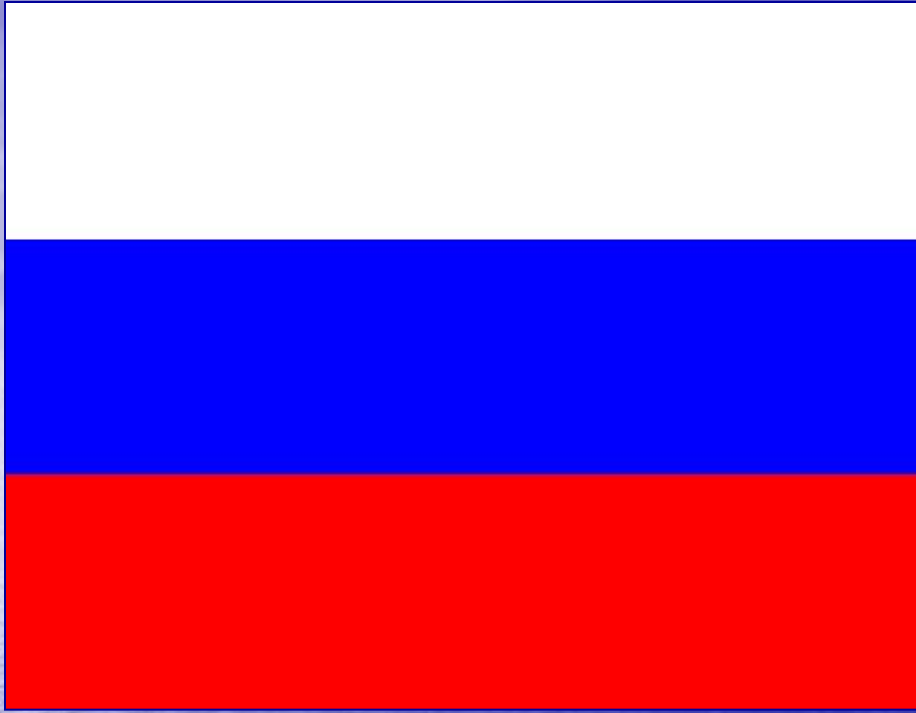

**ФЛАГ**











Ф ф

Федя ходит руки в боки,  
Значит, выучил уроки.





Ф ф

Филин, в книжку залетев,  
Превратился в букву Ф.



# Ф ф

Всем известно без подсказки,  
Буква Ф, как ключ из сказки,  
Никогда его у нас  
Не отнимет Карабас.





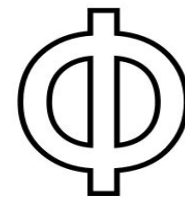
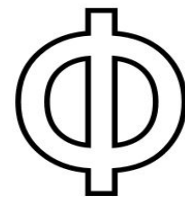
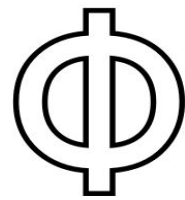
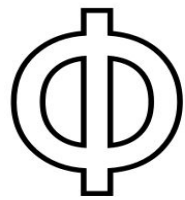
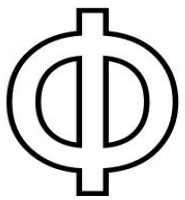
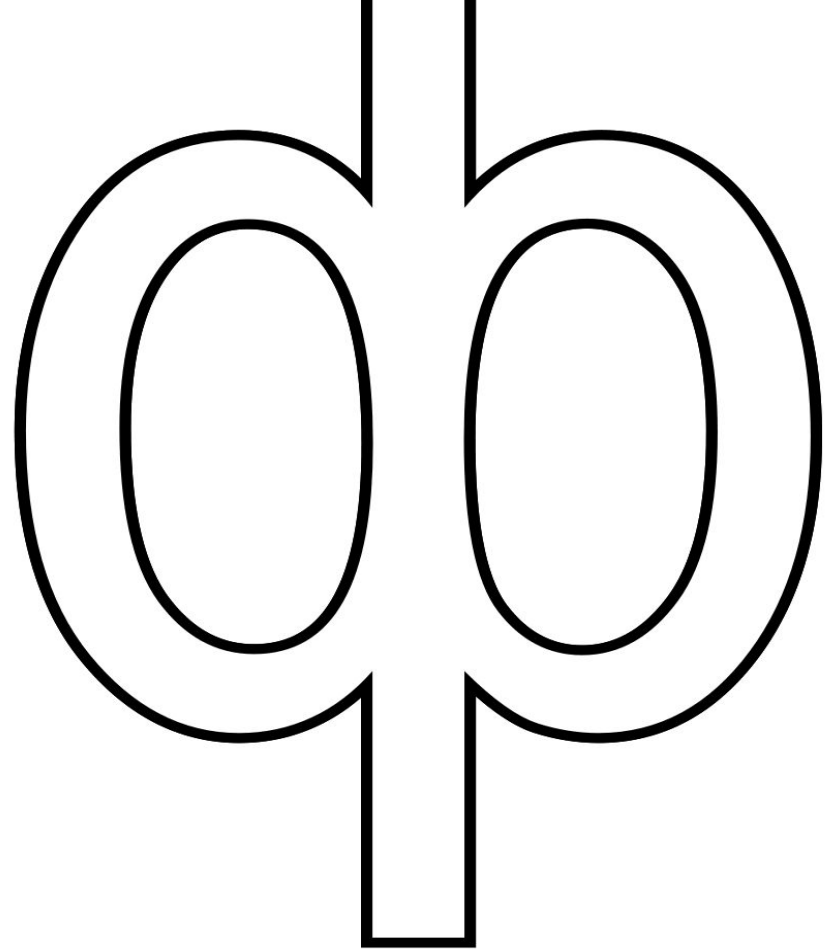
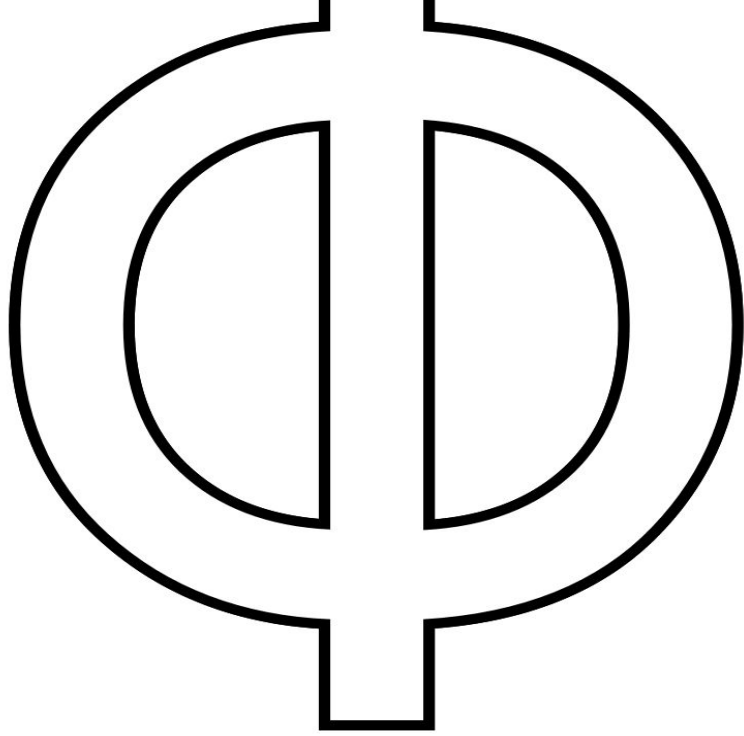



Ф ф

ФА ФО ФУ

ФЕ ФИ ФЫ



# Роза ветров - компас

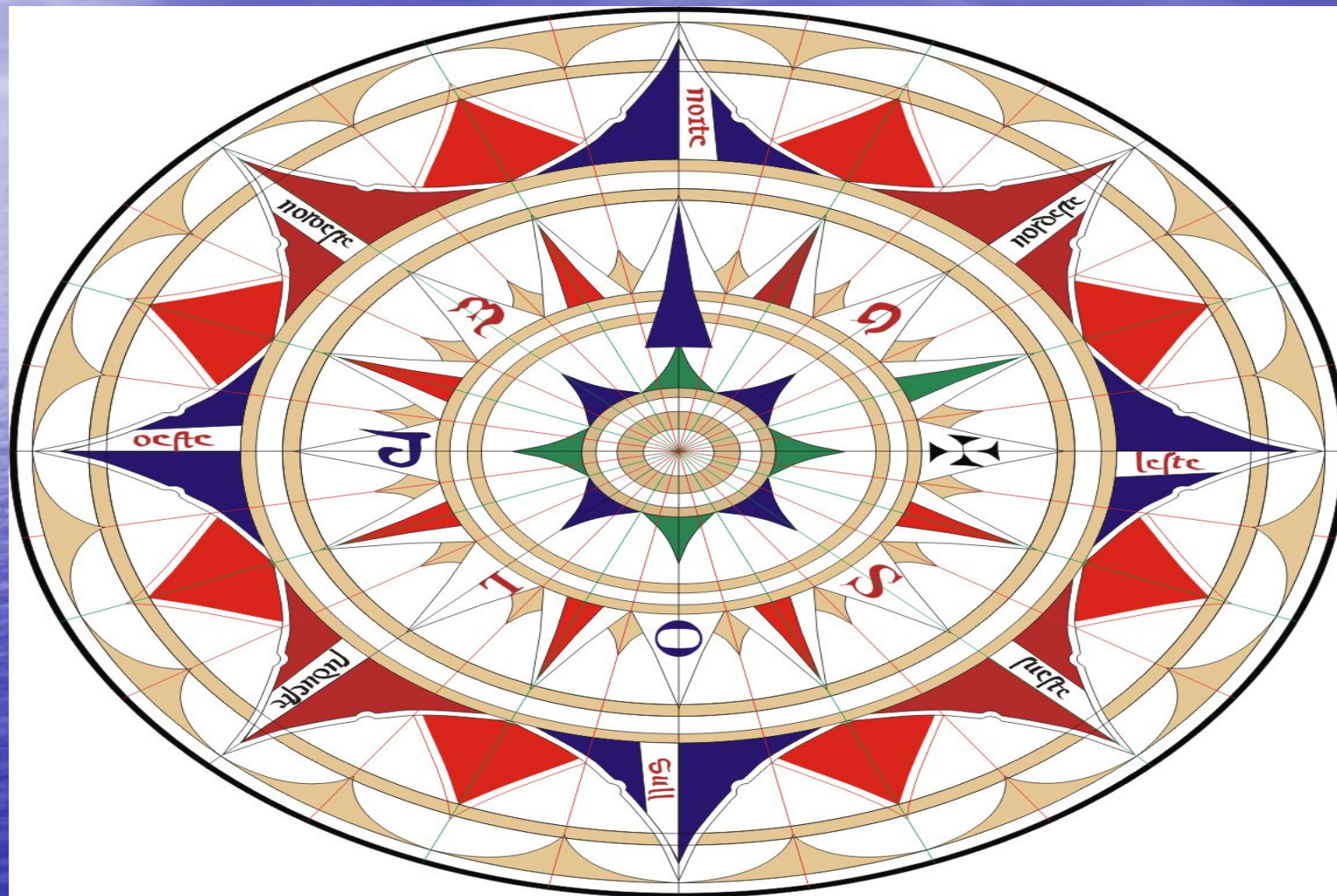

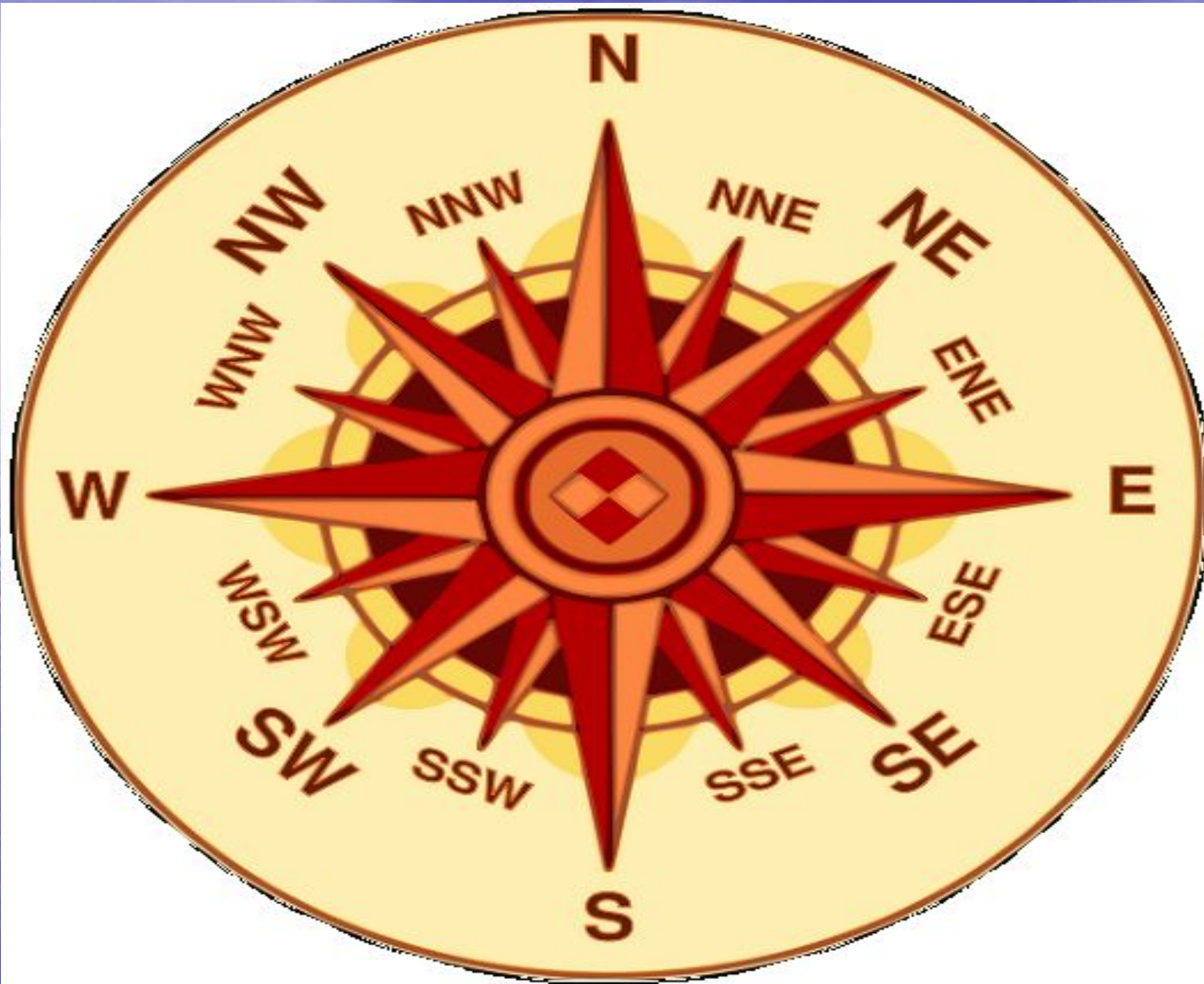



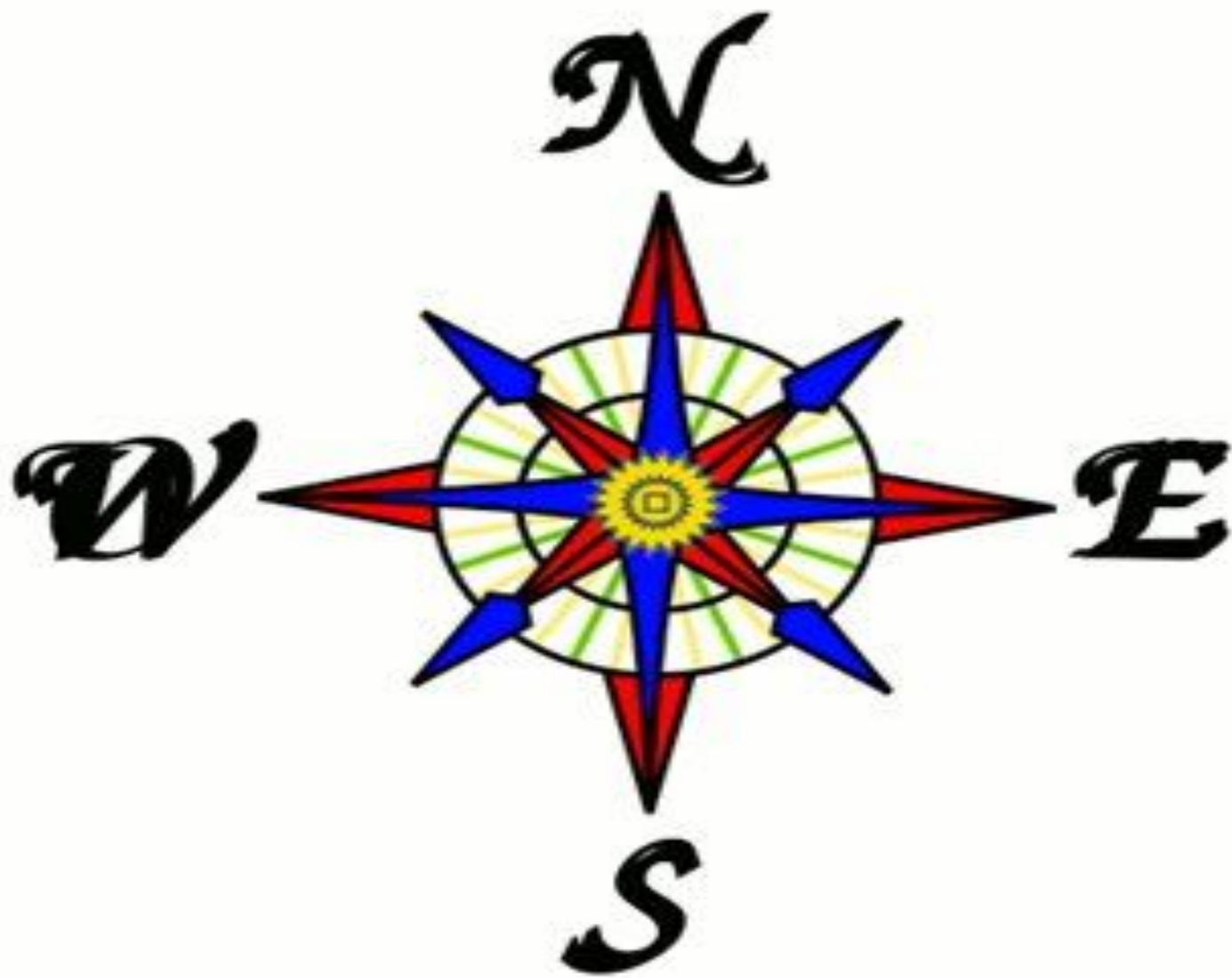



# Андреевский флаг



[www.garb.bal.ru](http://www.garb.bal.ru)

Андреевский флаг 1699/1700 гг.





# Петр I – первый русский флотоводец









А.С. Пушкин





# Санкт-Петербург

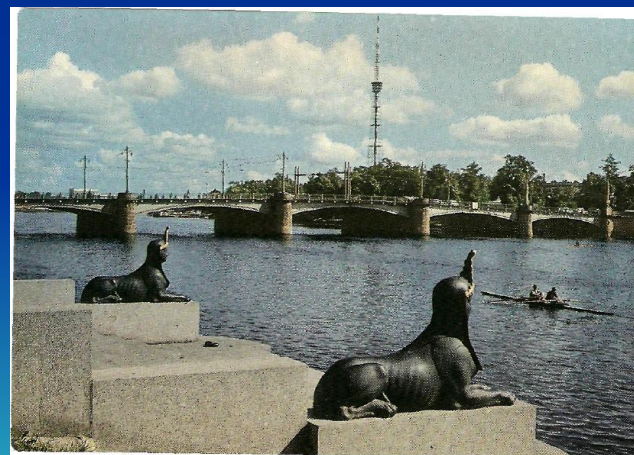
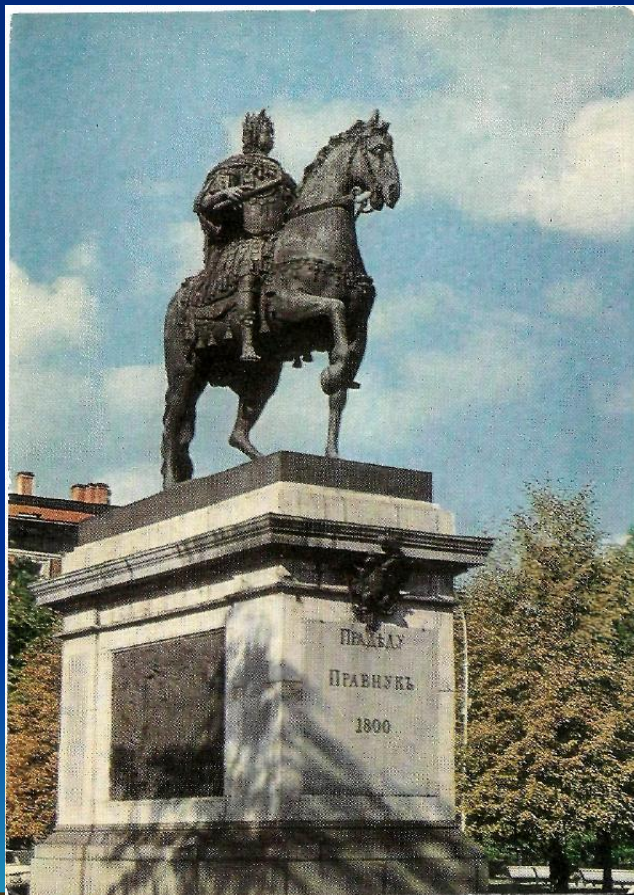

**.....ВЕТЕР НА  
МОРЕ ГУЛЯЕТ  
И КОРАБЛИК  
ПОДГОНЯЕТ;  
ОН БЕЖИТ СЕБЕ  
В ВОЛНАХ  
НА РАЗДУТЫХ  
ПАРУСАХ.**





«Сказка о царе Салтане,  
о сыне его славном и  
могучем богатыре  
Гвидоне Салтановиче и  
о прекрасной царевне  
лебеди»





Финики    вафли    фисташки

Кефир    конфеты

Зефир    фрукты





фла фор фы  
жок ма шар





# Спасибо за урок!



Прозвени-ка,  
дружок,  
Голосистый  
звонок.

Перемену ждут  
ребята.

Поиграть,  
попрыгать надо!



