



Alternative energy sources

Presented by
Vlad Buhnyak
Student group
21-E



Hydropower Energy



Solar Energy



Wind Energy

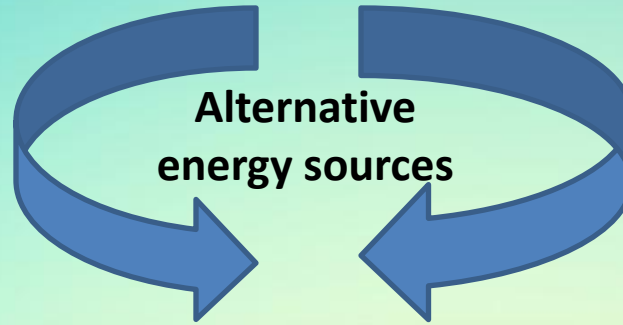

Geothermal Energy



Biomass Energy

Solar Energy



Wind Energy

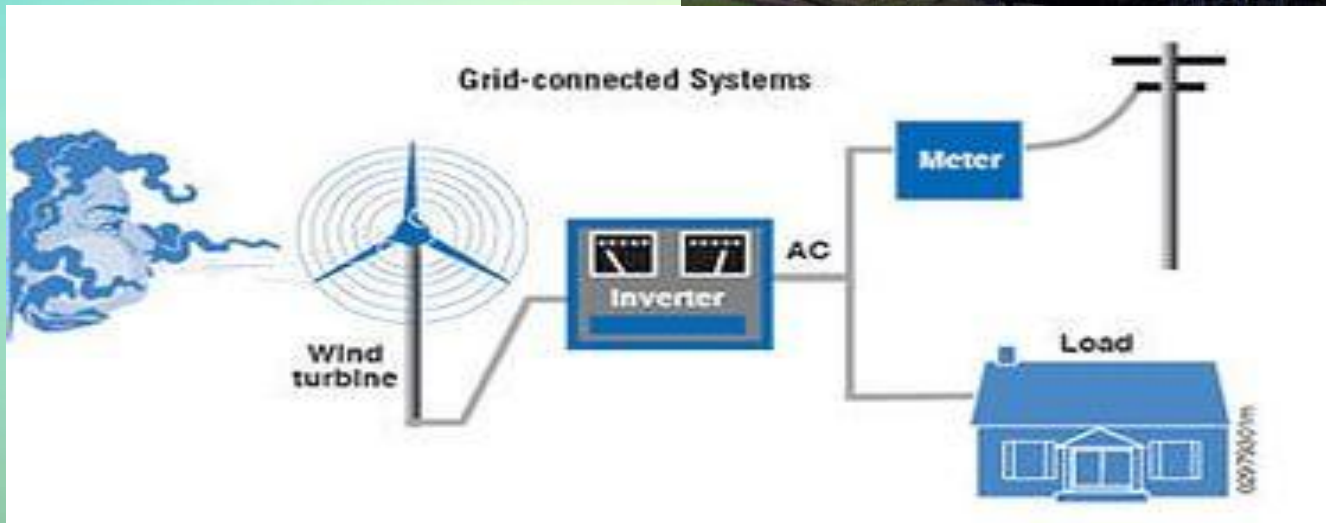

Geothermal Energy

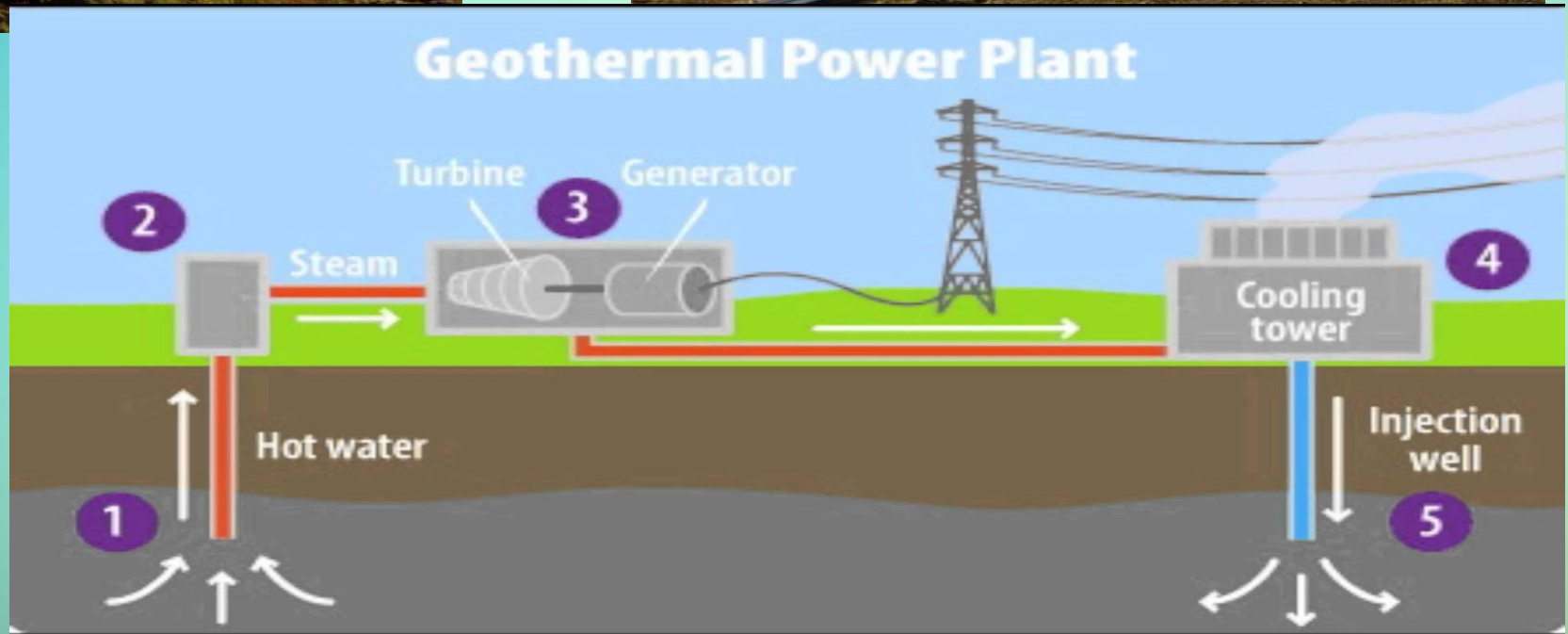
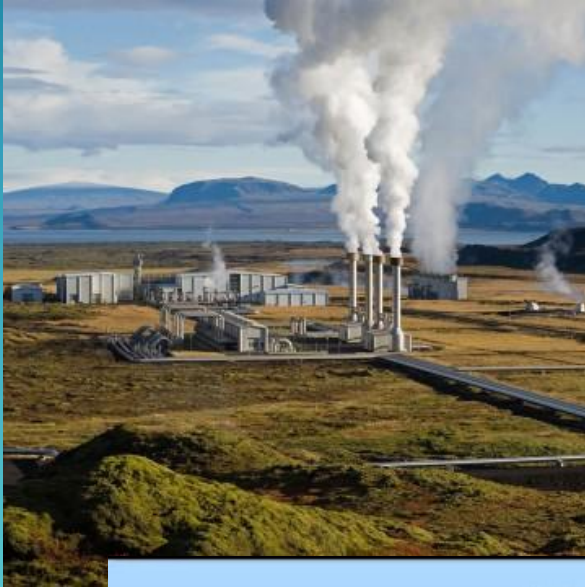

Biomass Energy

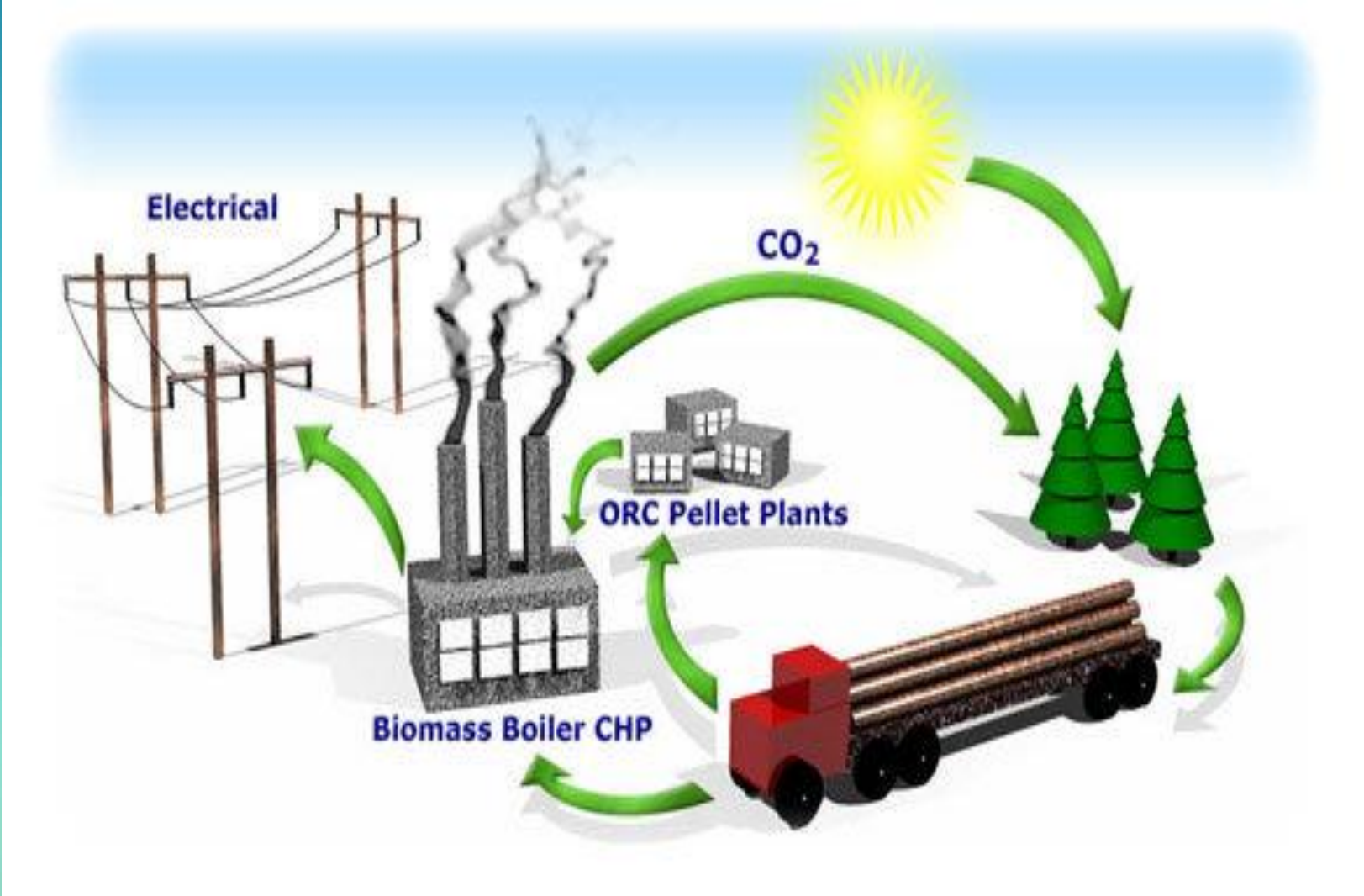

Hydroelectric Dam

Hydropower Energy

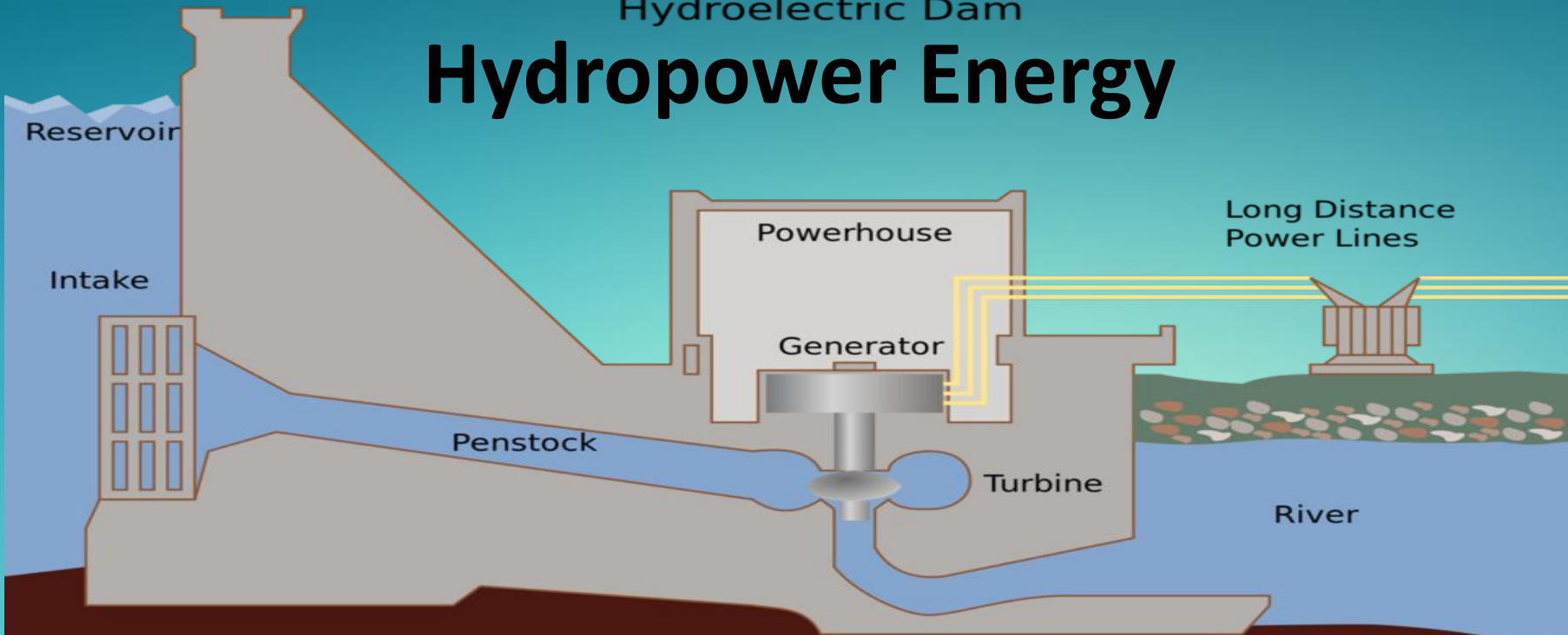



That's all,
thank you for your attention

