



# Оборудование для передвижения инвалидов- колясочников по лестницам

Проект Солодихиной Анны



Рис. 3



Встраиваемая в коляску конструкция

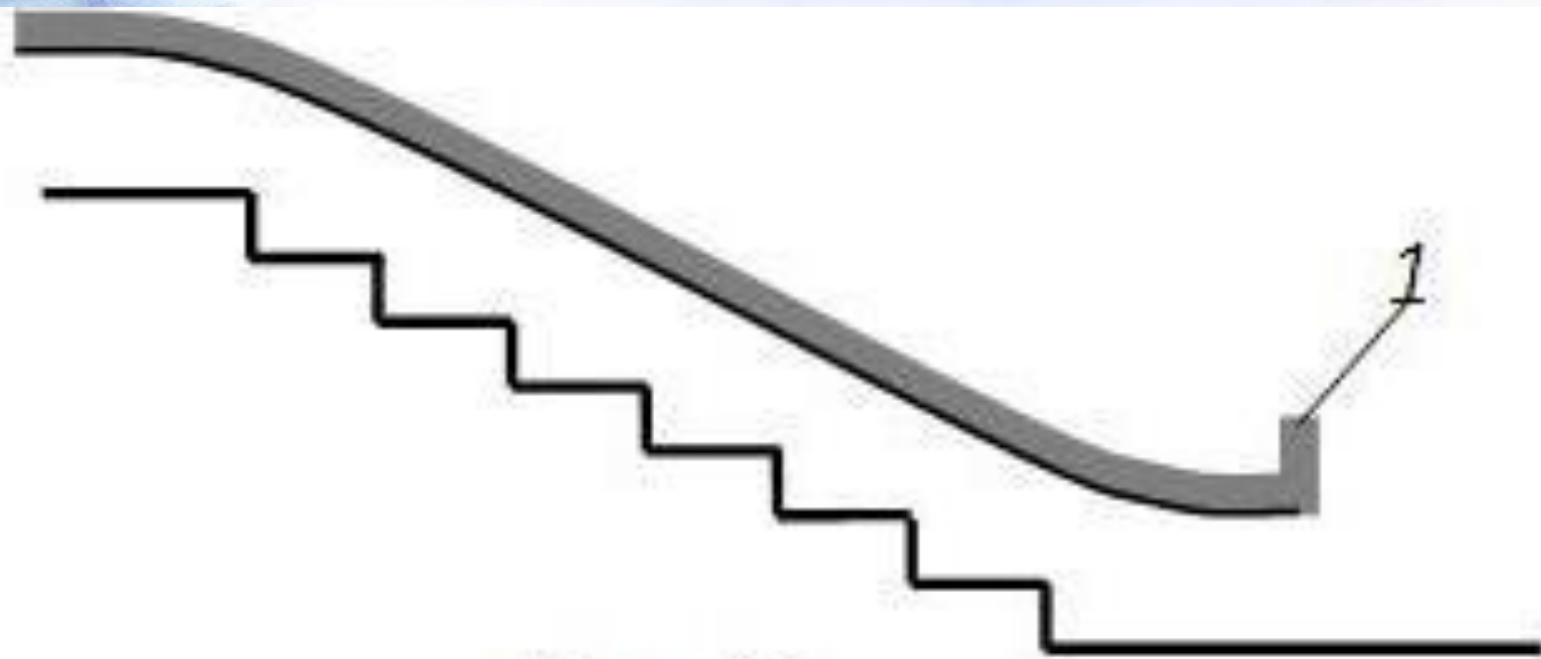
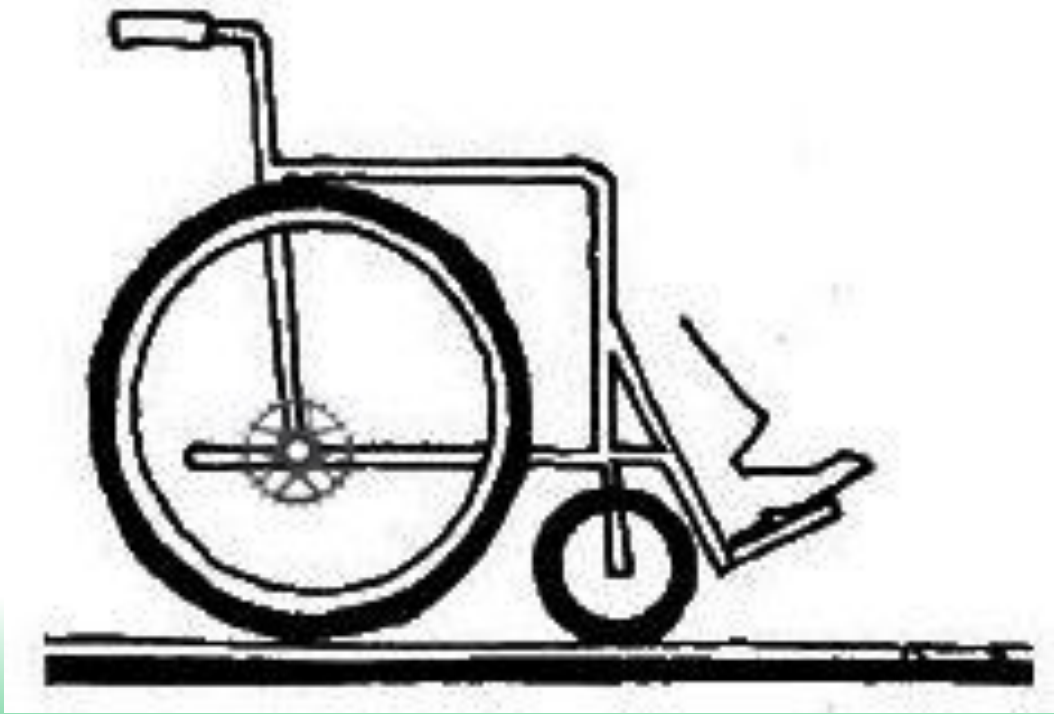

## Схема устройства

Надеваемая на ручки коляски конструкция



Рис. 4

# Принцип действия

1. Надеваем устройство на ручки кресла

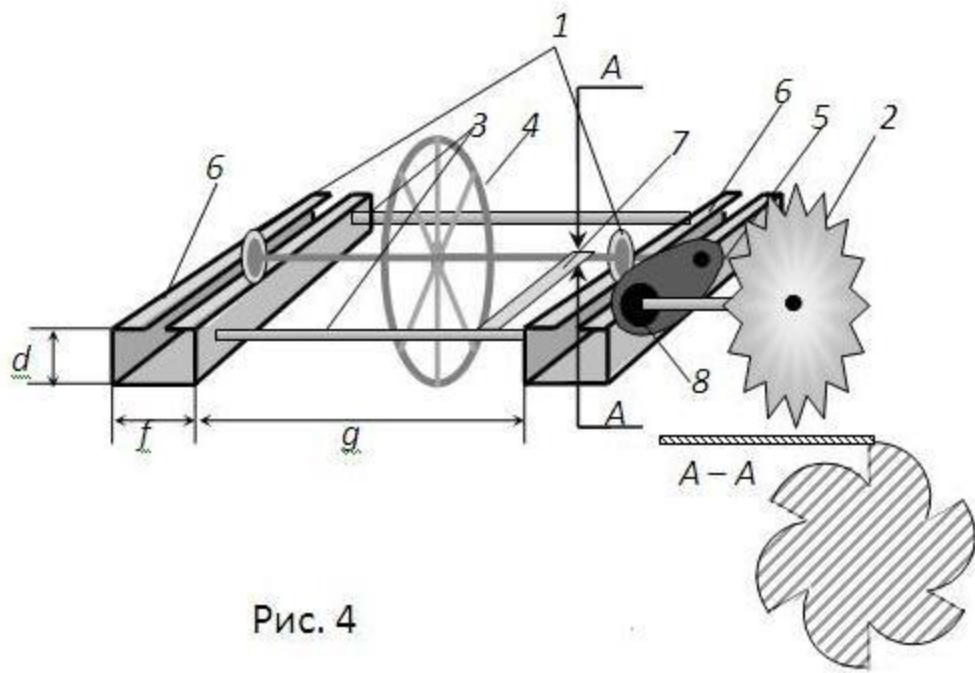
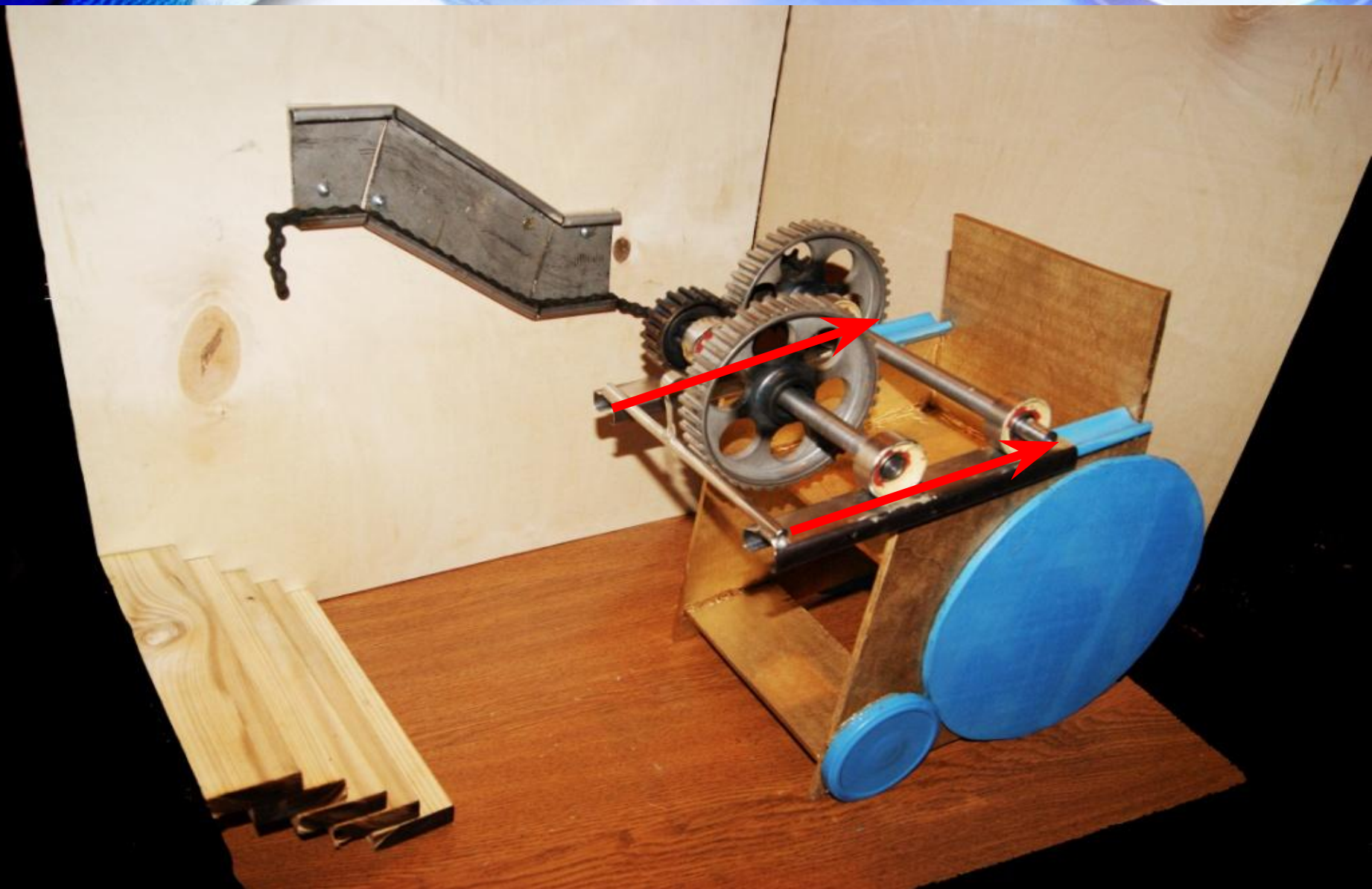

# Принцип действия

2. Вставляем звёздочку в желоб с велосипедной цепью

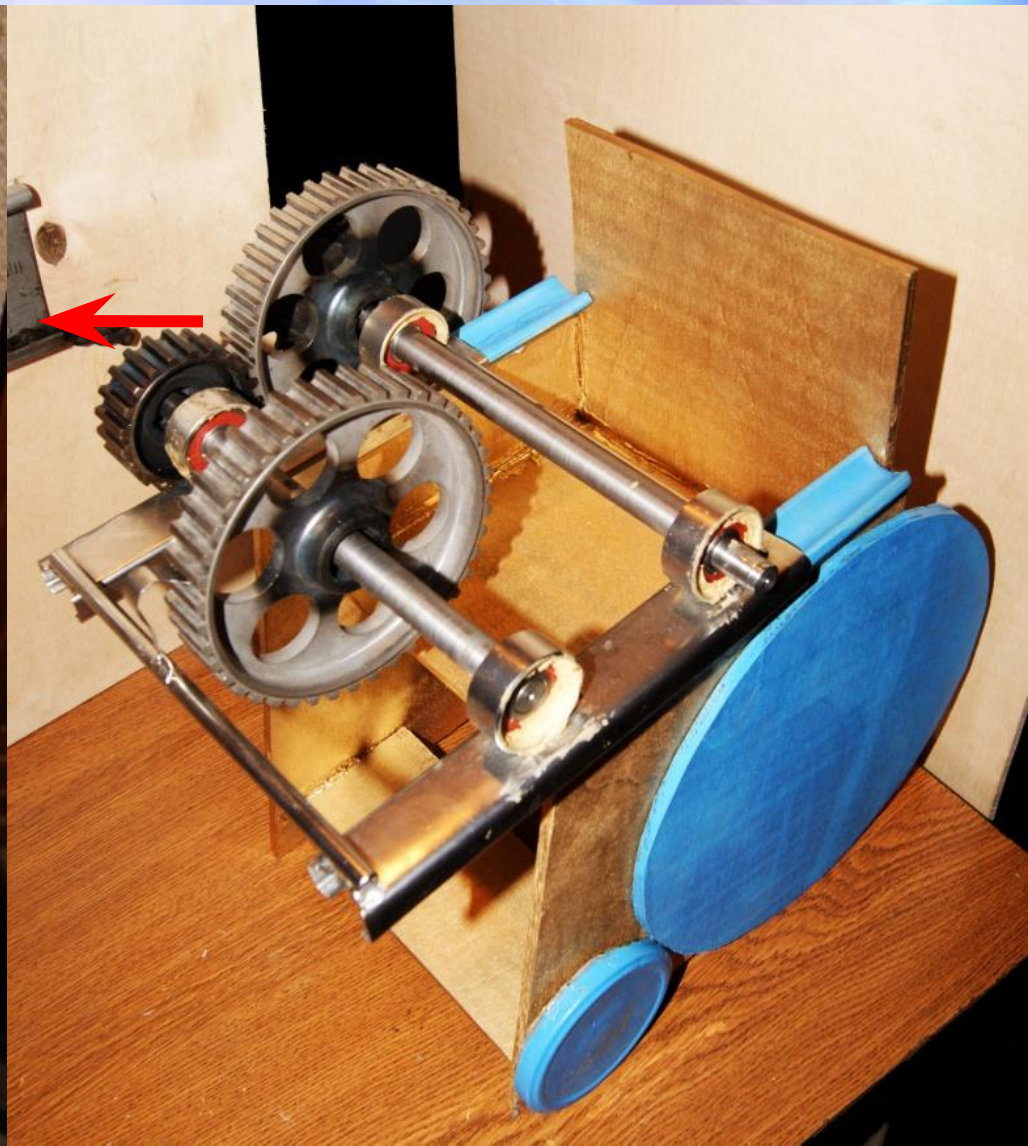

# Принцип действия

3. Вращаем колесо на себя

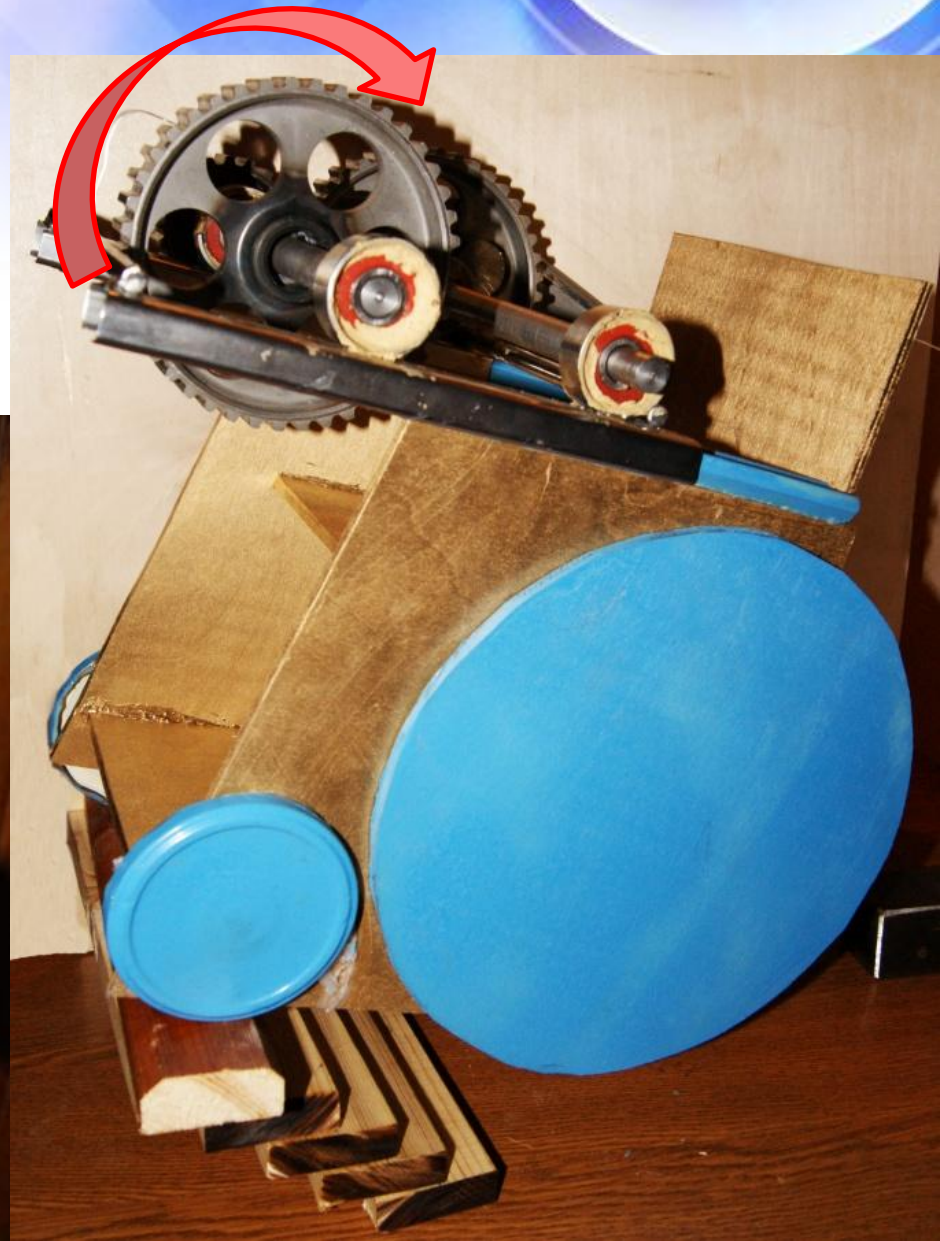
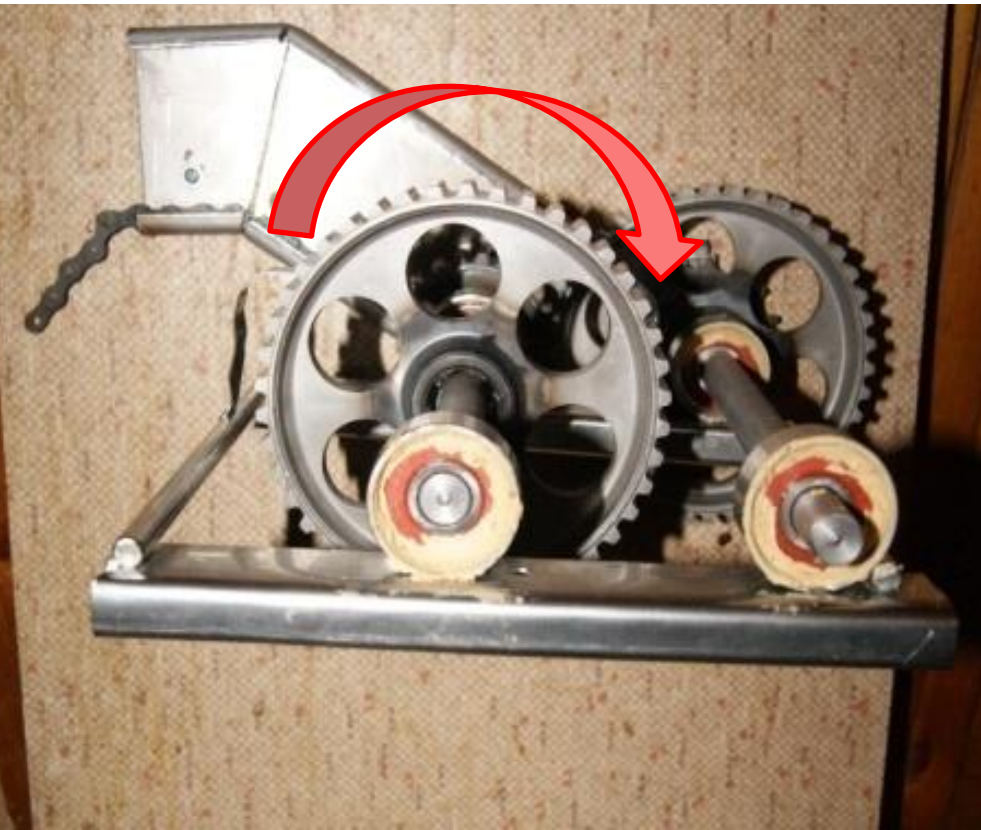

The background features a complex, abstract design. The top portion is dominated by various shades of blue, with overlapping geometric shapes like triangles and squares. On the left side, there are faint, semi-transparent numbers: '6', '5', and '4' are visible in the upper left, and '3' and '2' are visible below them. The bottom portion of the image is a solid, vibrant green gradient that transitions from a lighter shade at the top to a darker shade at the bottom. The overall composition is clean and modern, typical of a professional presentation slide.

**Спасибо за внимание!**