

Робот LEGO Mindstorms EV3



Переносчик кубиков



Сортировщик кубиков

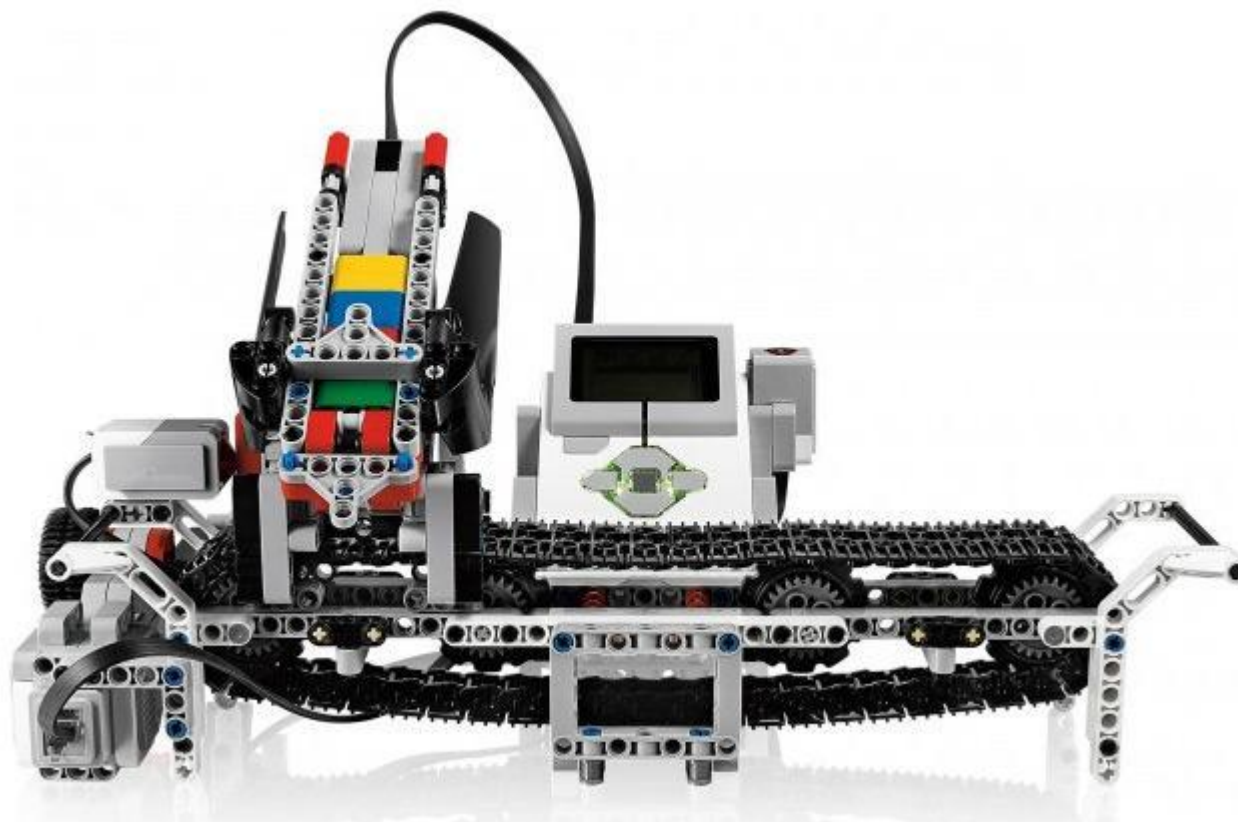

Рука



Змея



Робот - исследователь



Робот с гироскопом на двух колесах



Грозное насекомое



Слон



Пока без названия

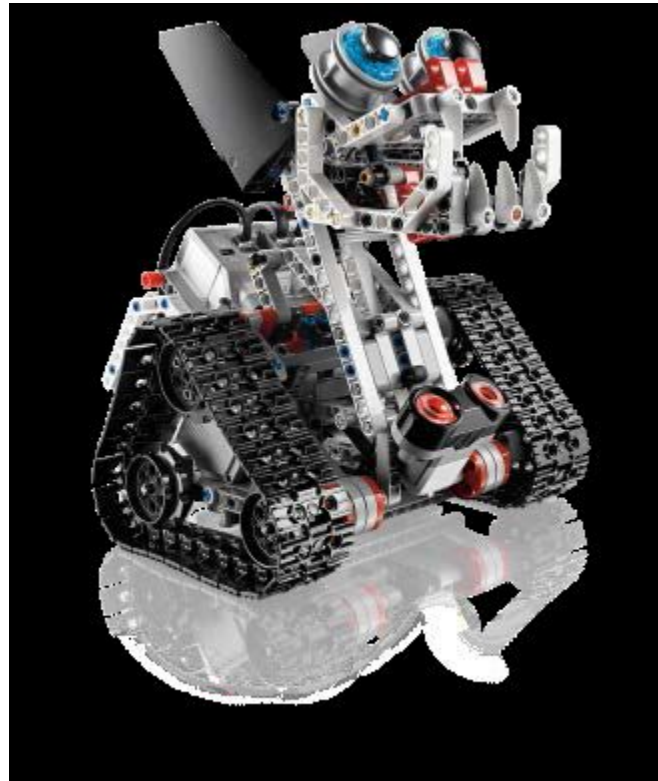

Автопогрузчик



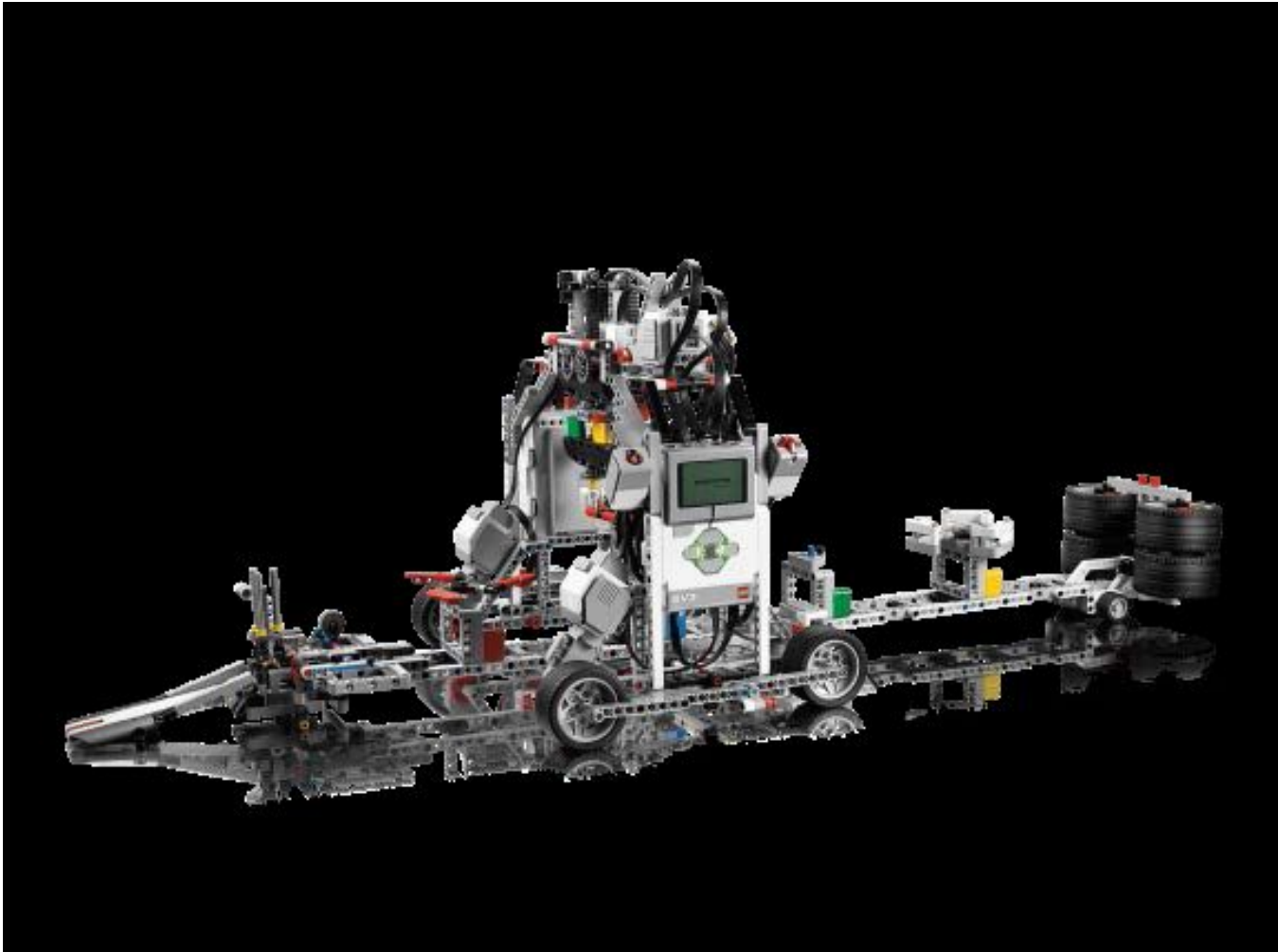

Гусеничный трактор





Собака



Среда графического программирования EV3 Education software

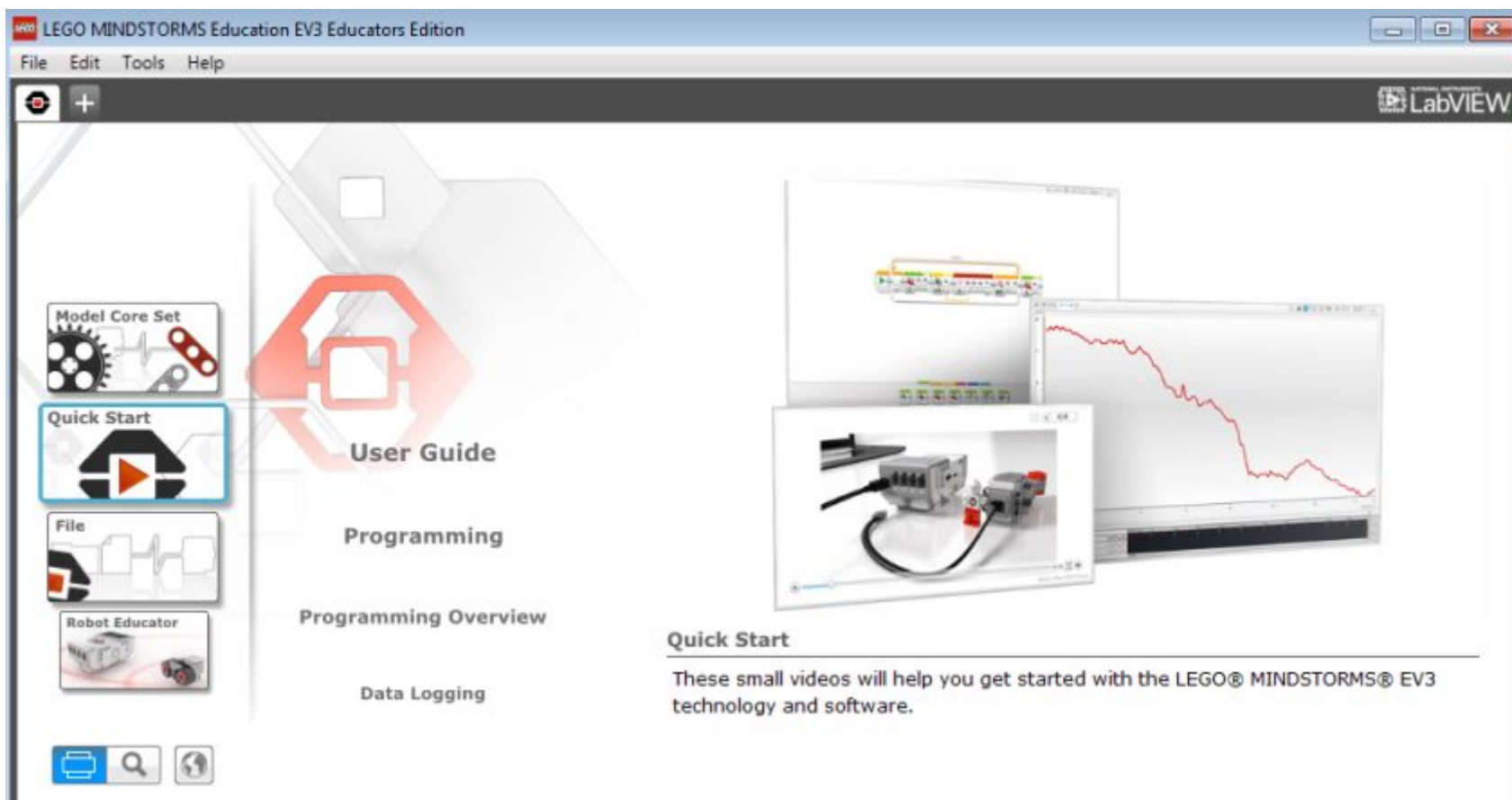

Учебные конструкции в базовом наборе EV3



Model Core Set

These models will inspire and challenge your robotic skills. Take LEGO® MINDSTORMS® EV3 to another level.

Базовые робоконструкции



Gyro Boy

Gyro boy is a self-balancing robot that takes advantage of all EV3 motors and sensors as well as advanced programming to control its behaviors.

Вид окна среды с Gyro Boy

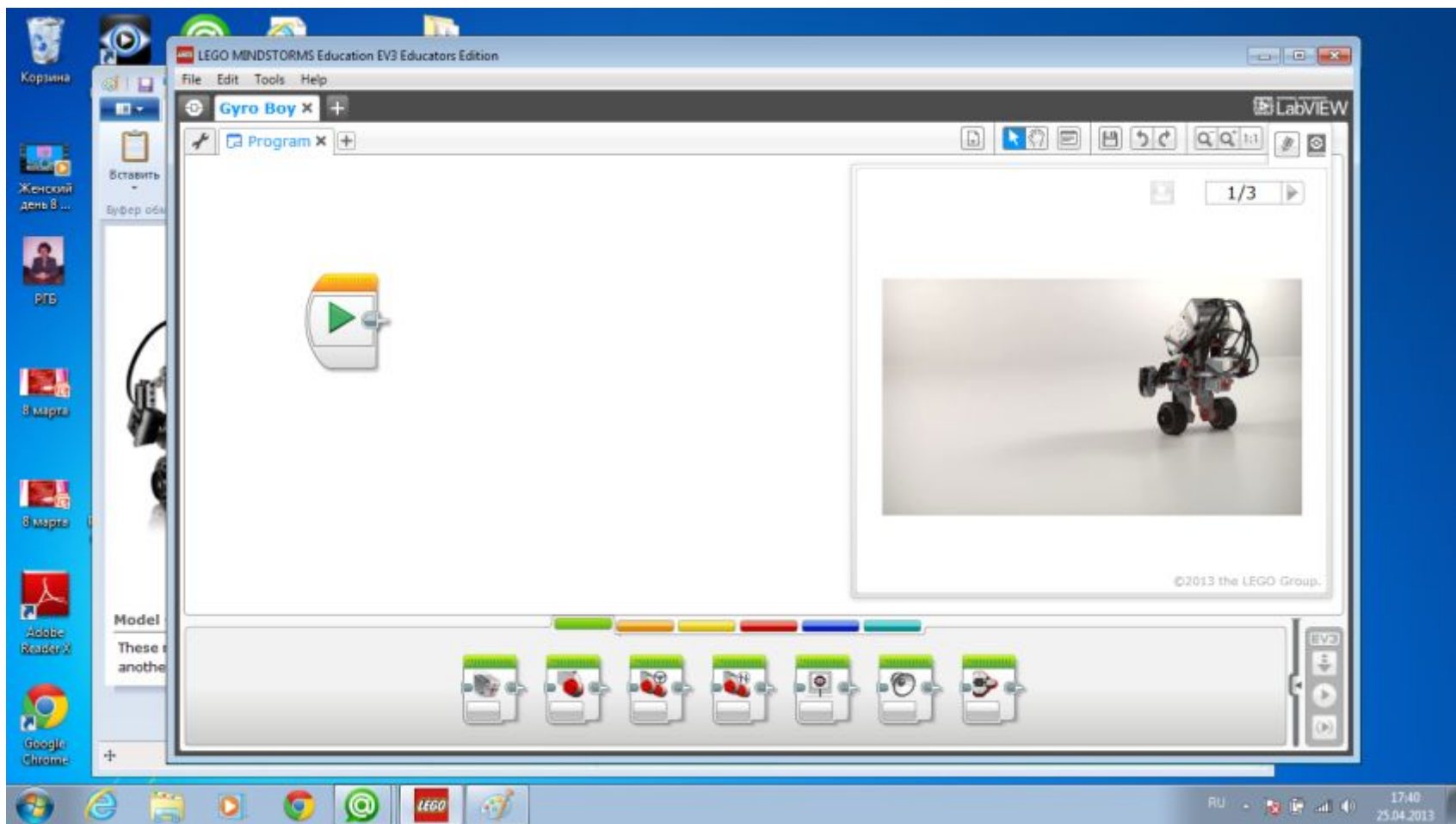

Объемный чертеж Gyro Boy

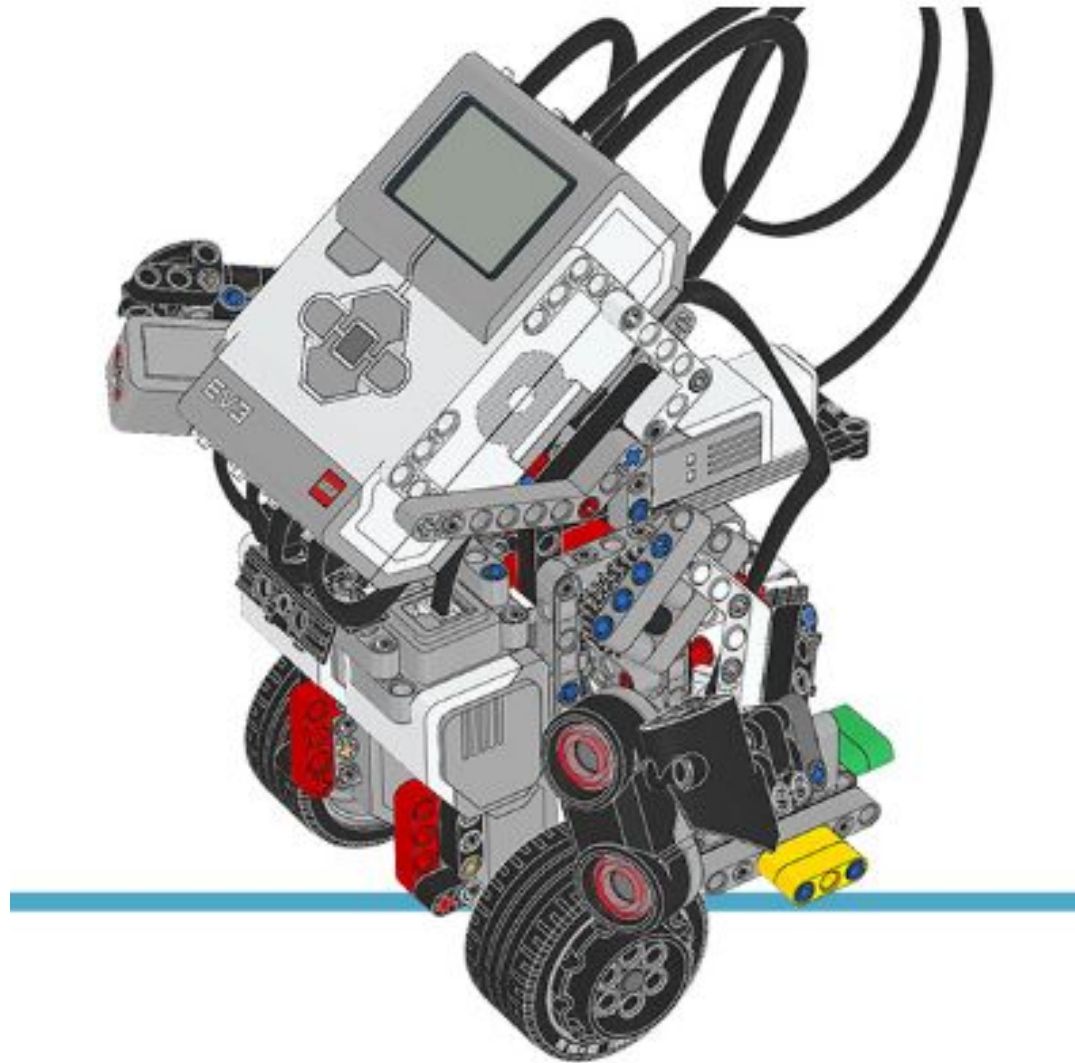

Фрагмент сборочной инструкции

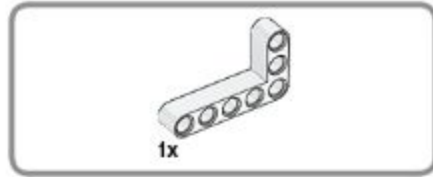

14

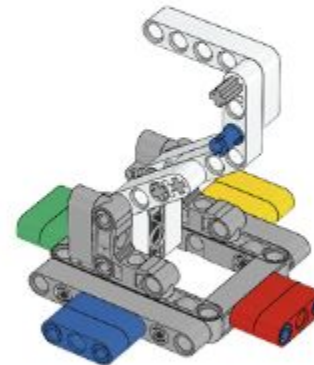

Фрагмент ветви балансировки



Продолжение ветви балансировки

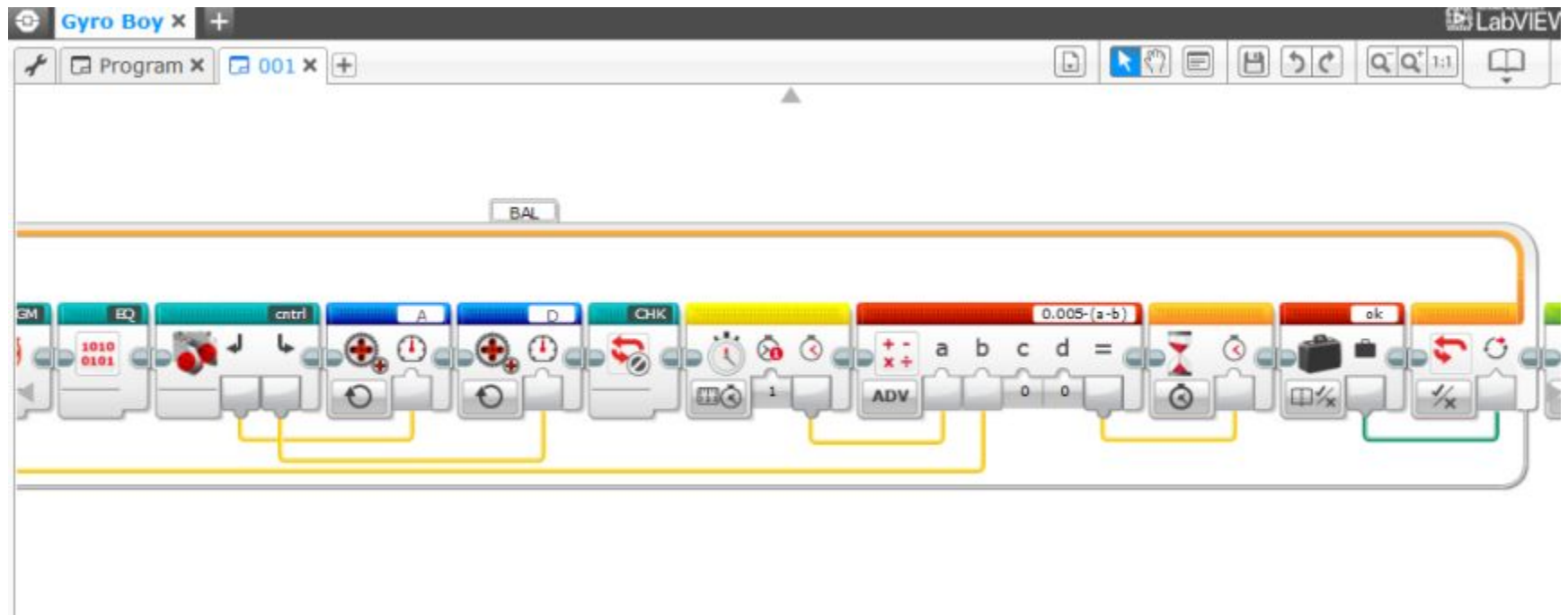

Фрагмент ветви движения

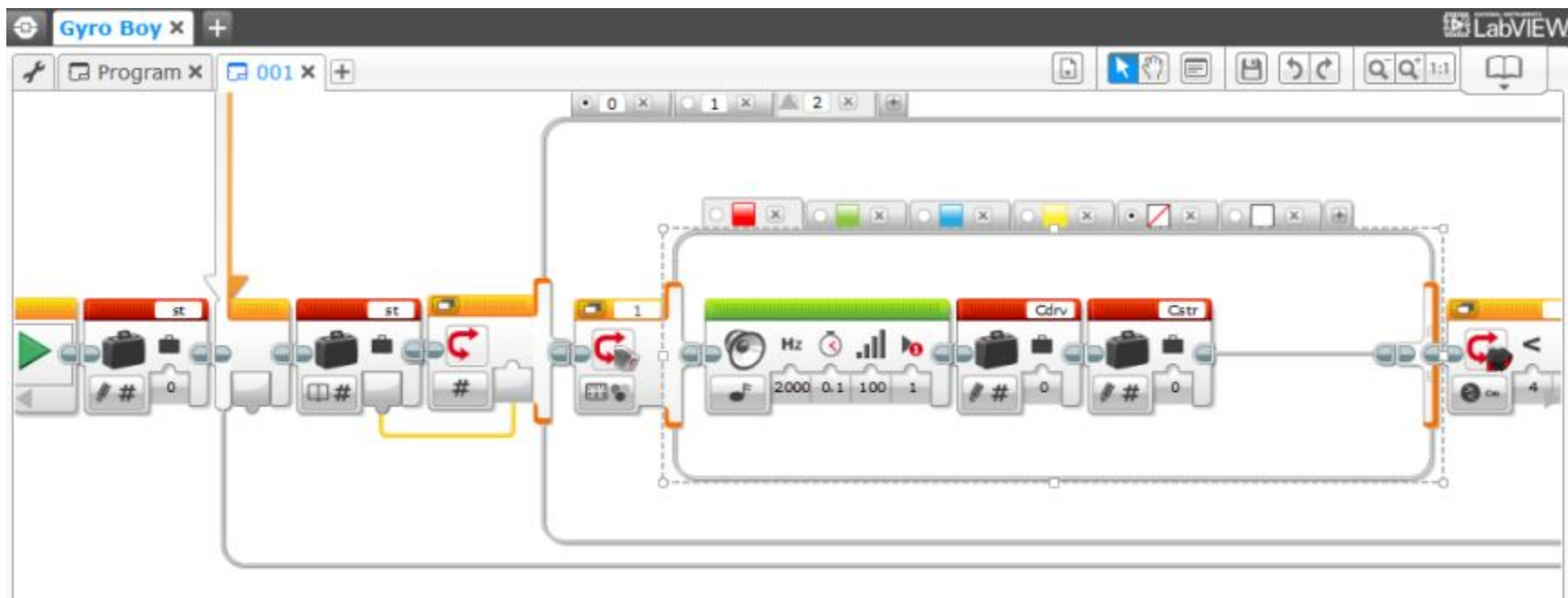

Общий вид программы Guro Boy

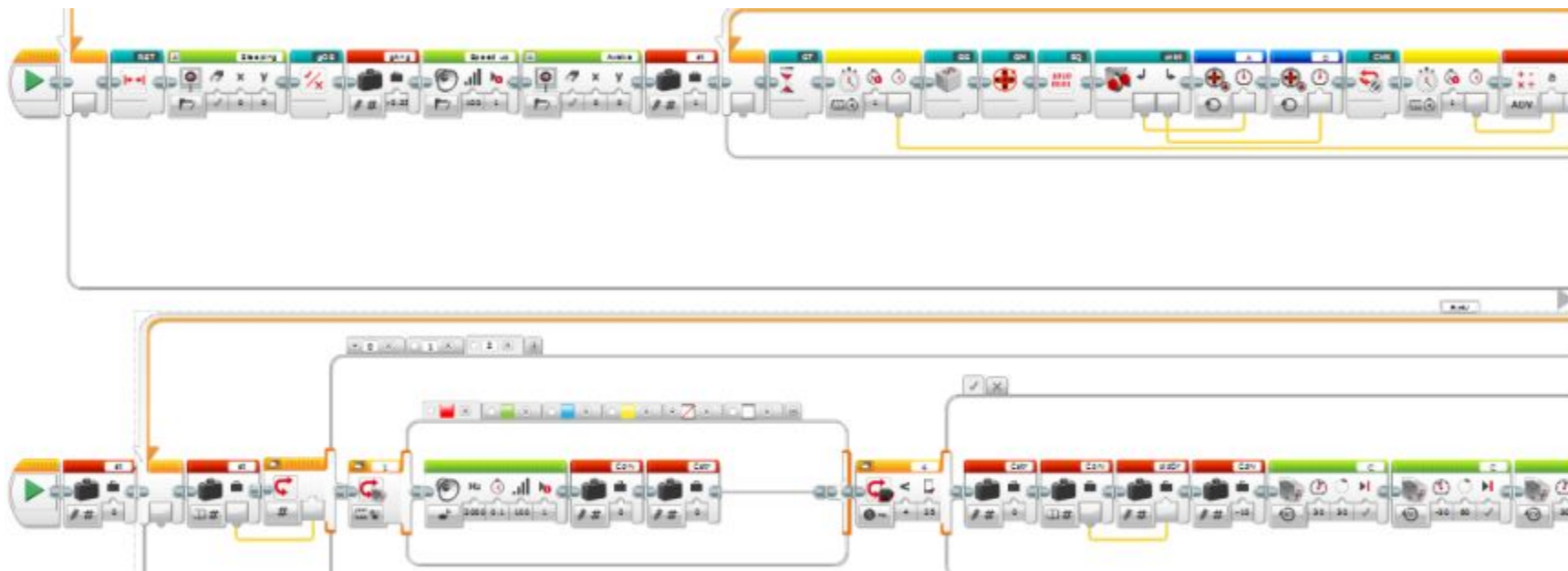

Чертеж сортировщика по цвету

Color sorter

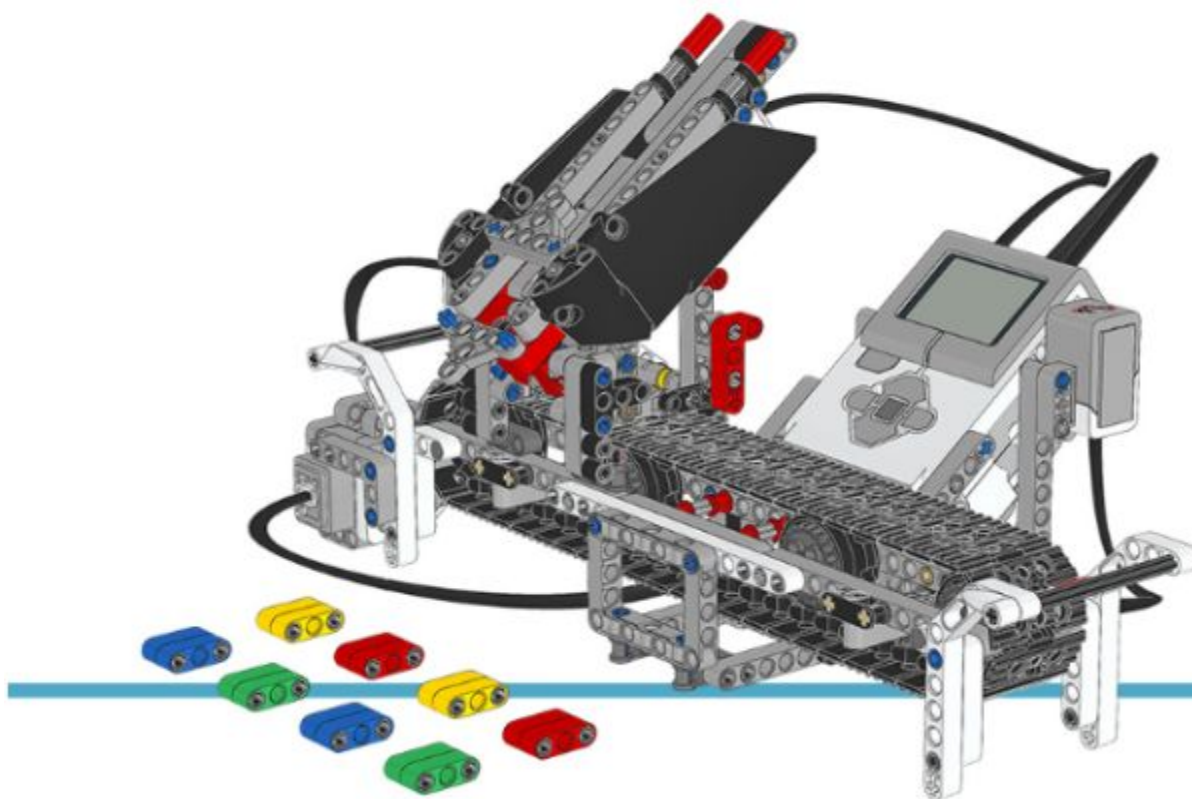

Фрагмент программы сортировщика



Собачка Пуппи - видео

Puppy



1/3



0:49



Пуппи – фрагмент сборочной инструкции

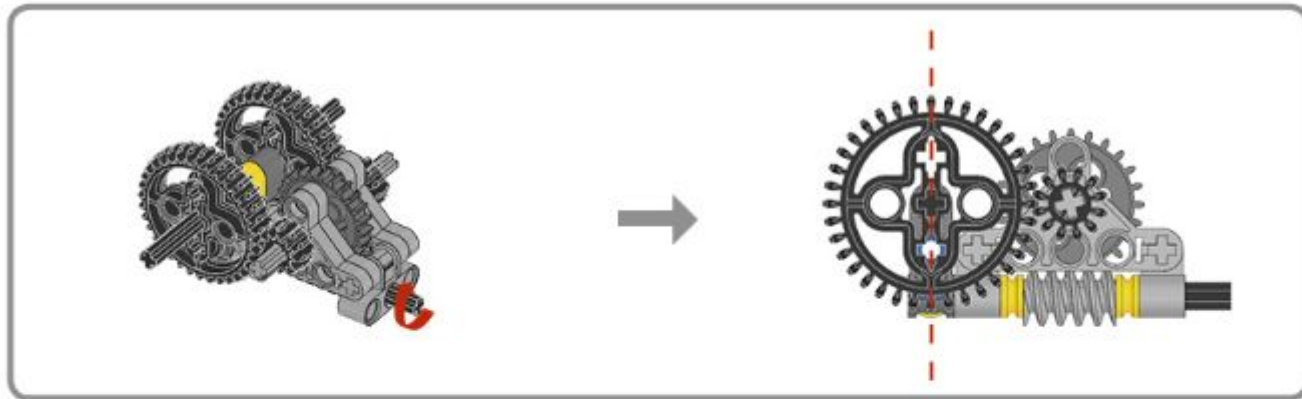

Интерактивная анимация

Interactive Animation (click blocks to play)

3/5



Сборка тестовой программы

Test It



Recreate the program shown, then download and run to test.

Click Blocks

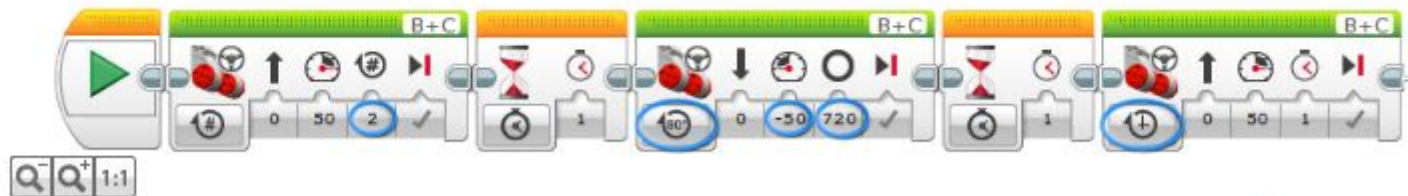

Робот Рука H25

Robot Arm H25

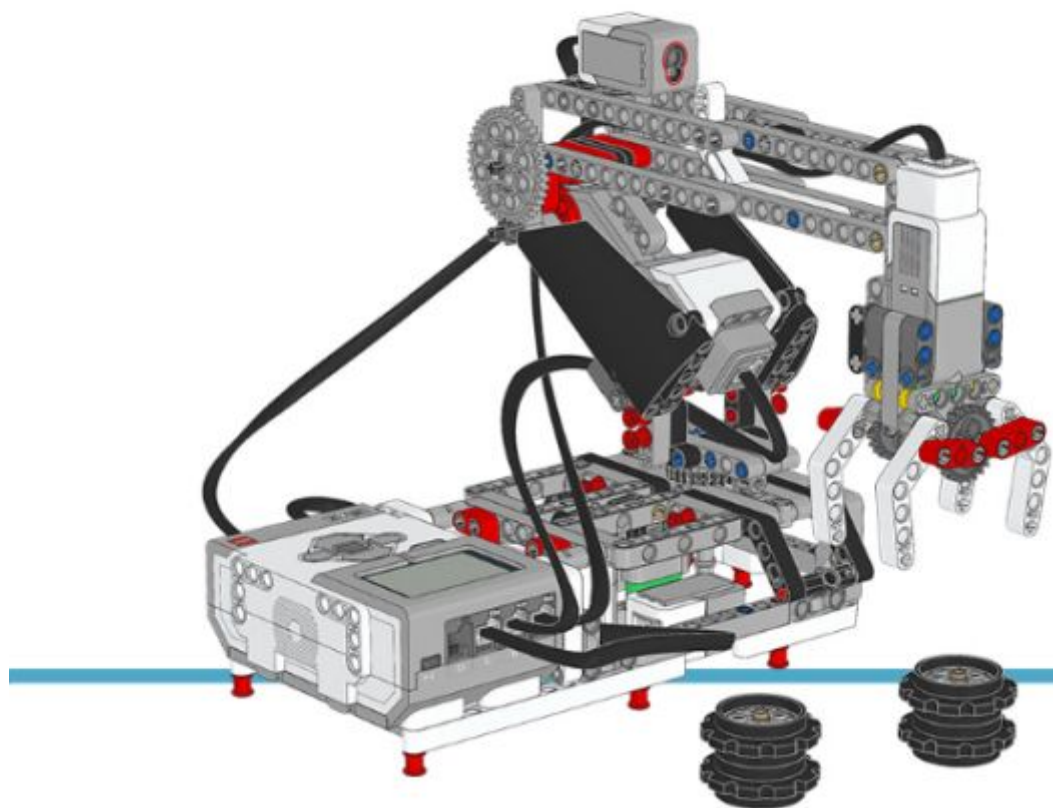

Возможности редактора контента

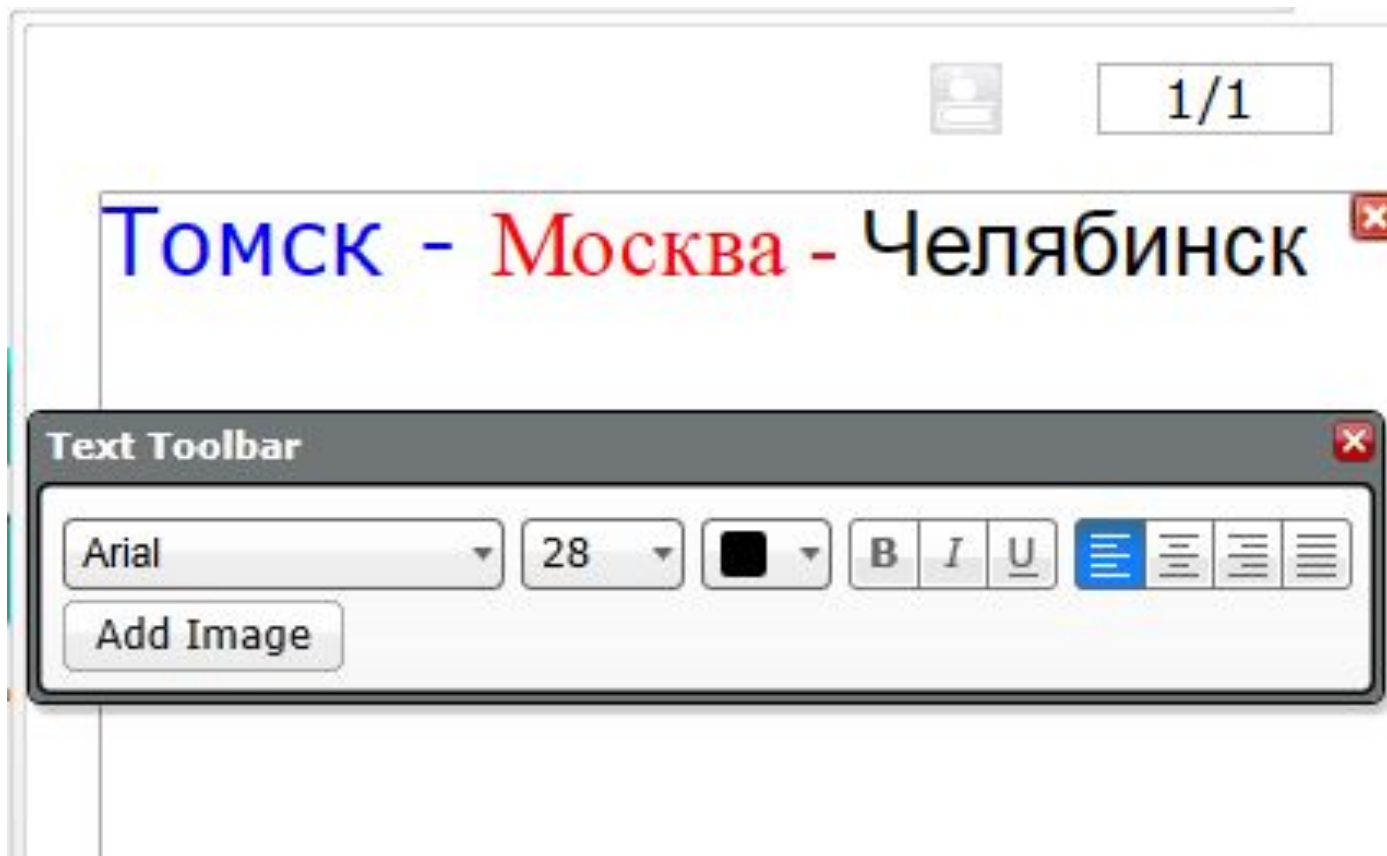

Группа блоков «Действие» (Action)

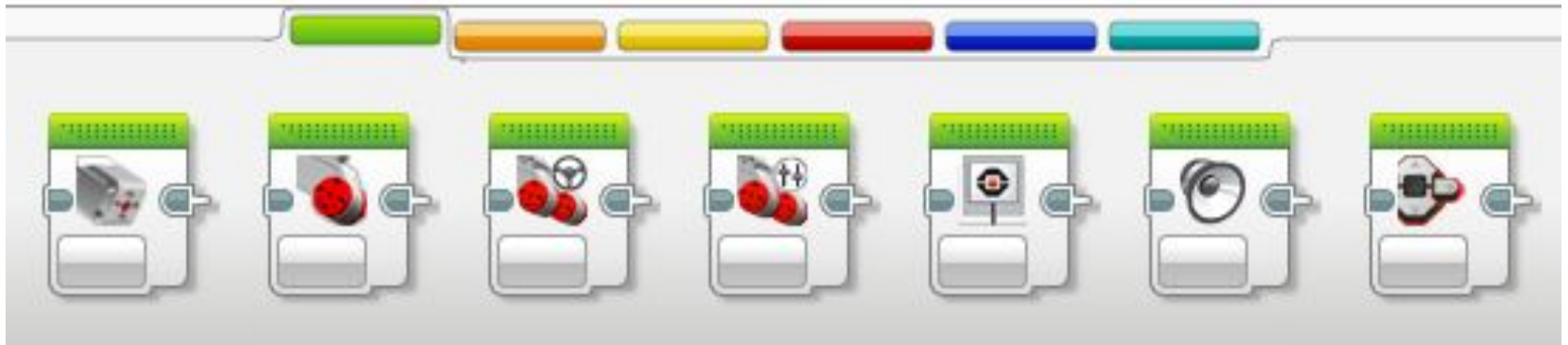

Группа блоков «Поток» (Flow)

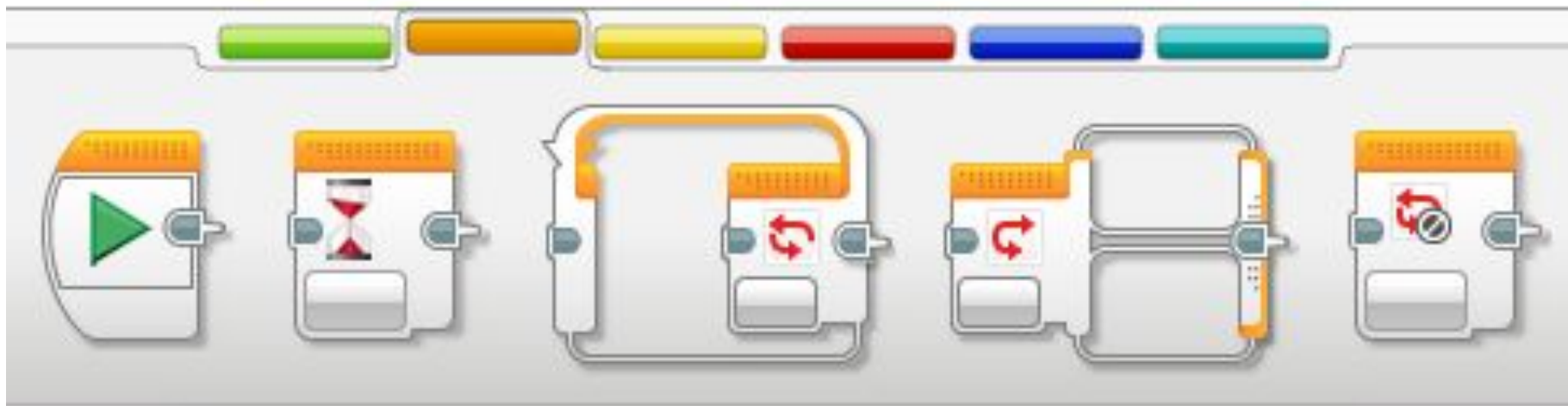

Группа блоков «Датчики» (Sensors)

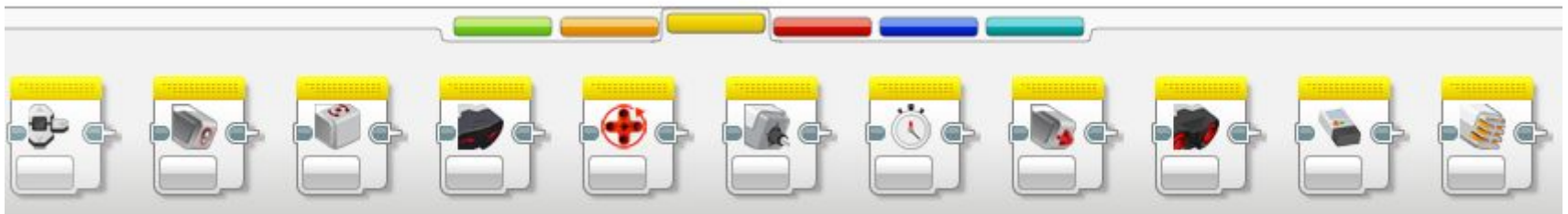

Группа блок «Математика» (Math)

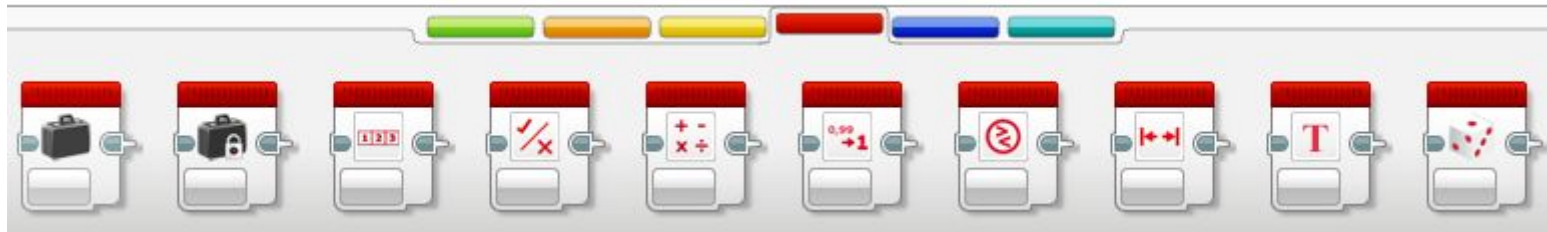

Работа с данными (Data)

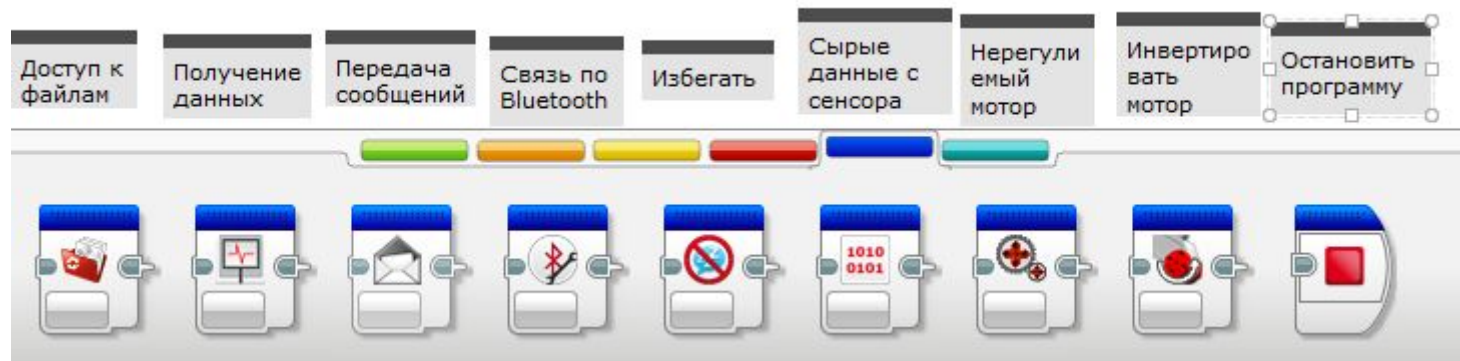

Контроллер загрузки/запуска



Общий вид программы на ВЫЧИСЛЕНИЯ

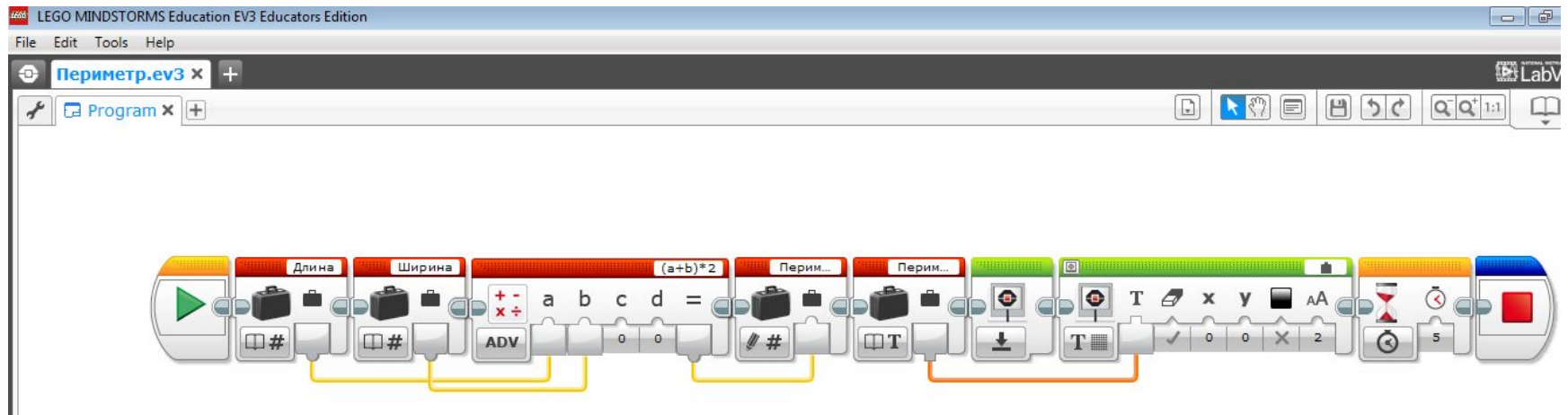

Патенты на софт EV3

