

Fold on the bottom line

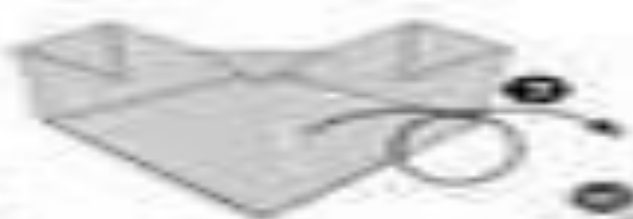

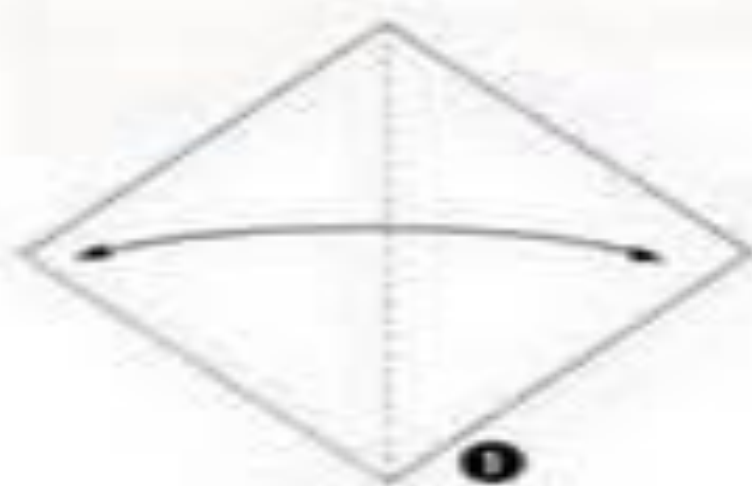

1

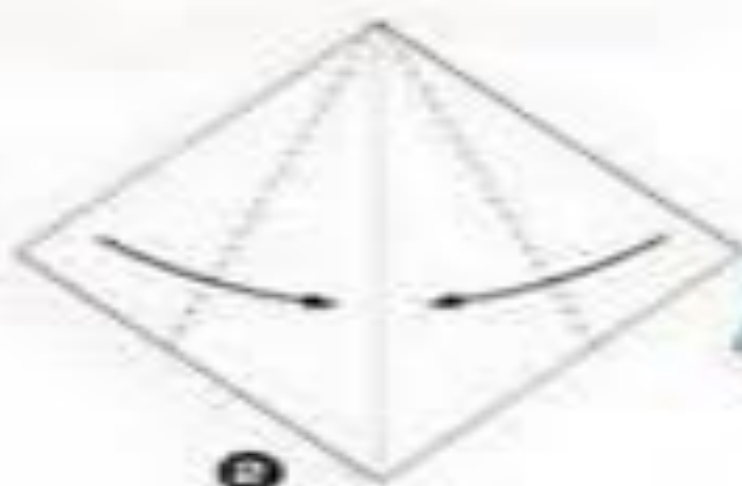

2

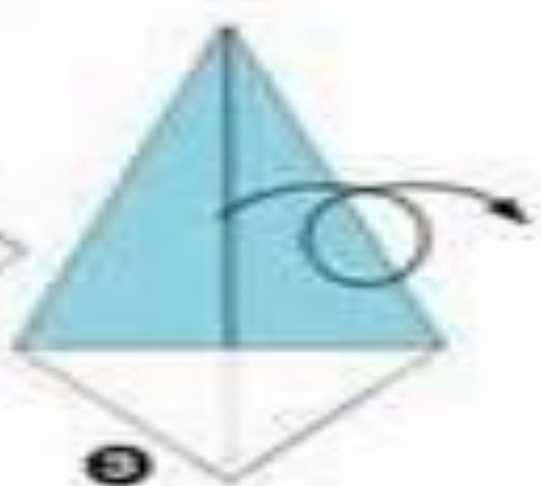

3



4



5



6



7



8

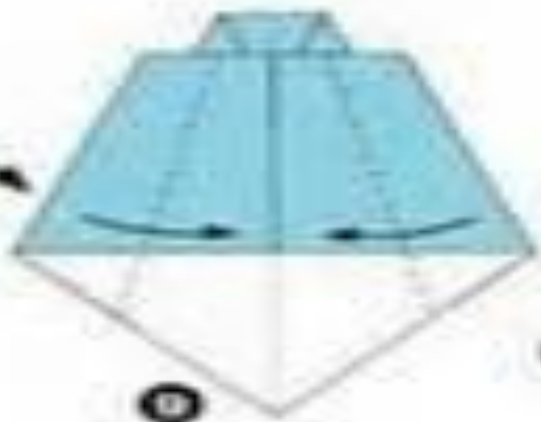

9



10



11

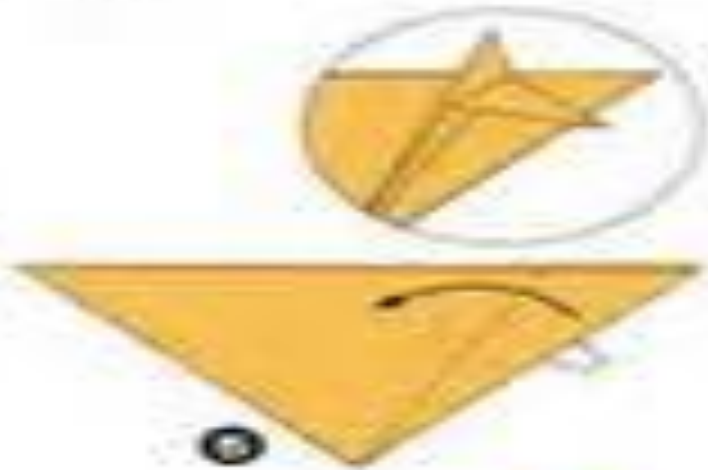
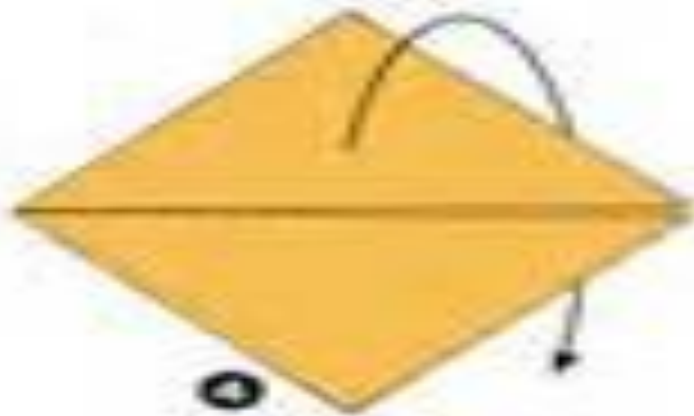
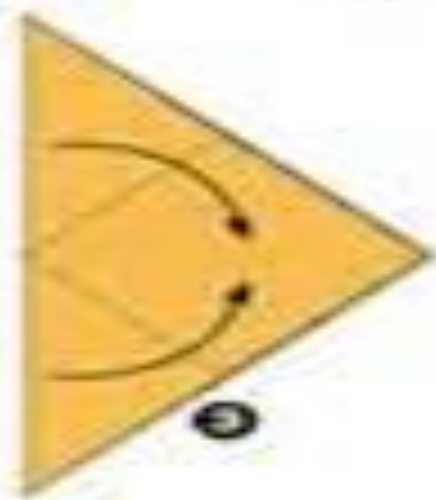
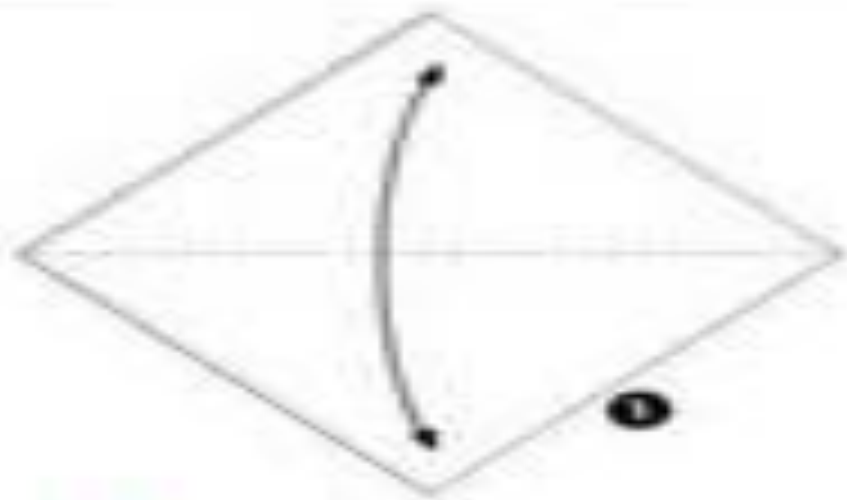

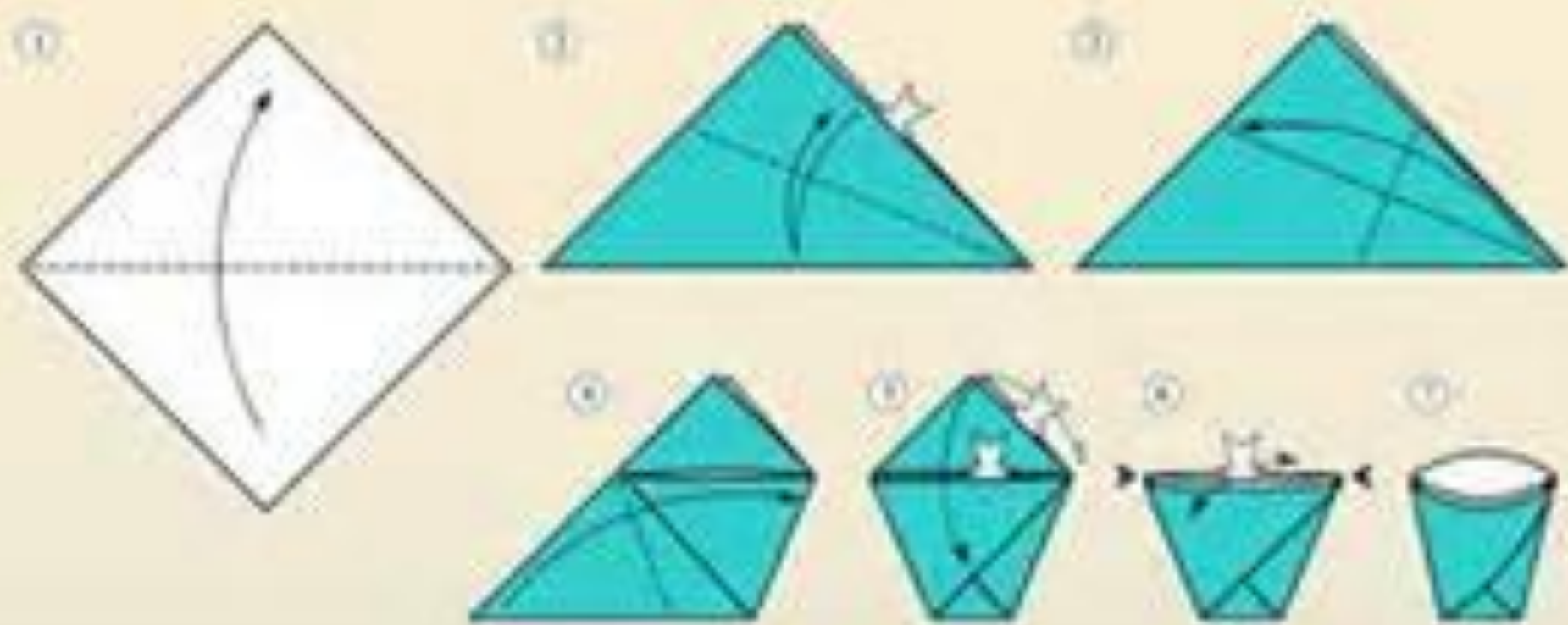



1

<http://stranaorigami.ru>

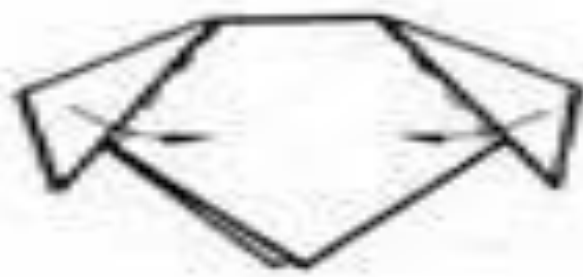

2

<http://stranaorigami.ru>

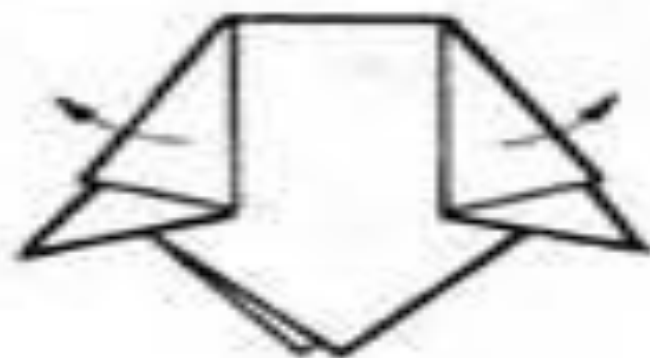

3



4



5

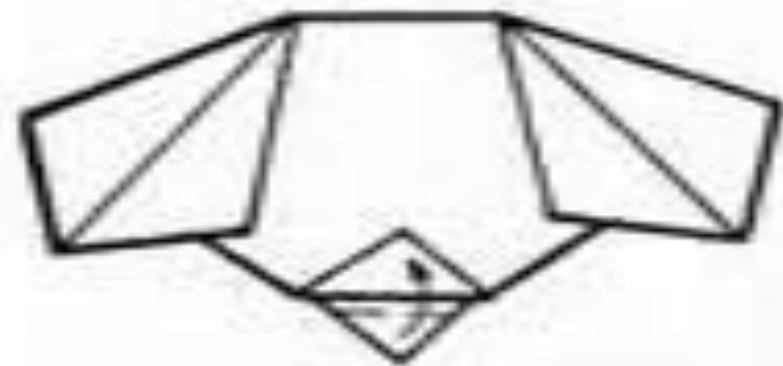

6



7

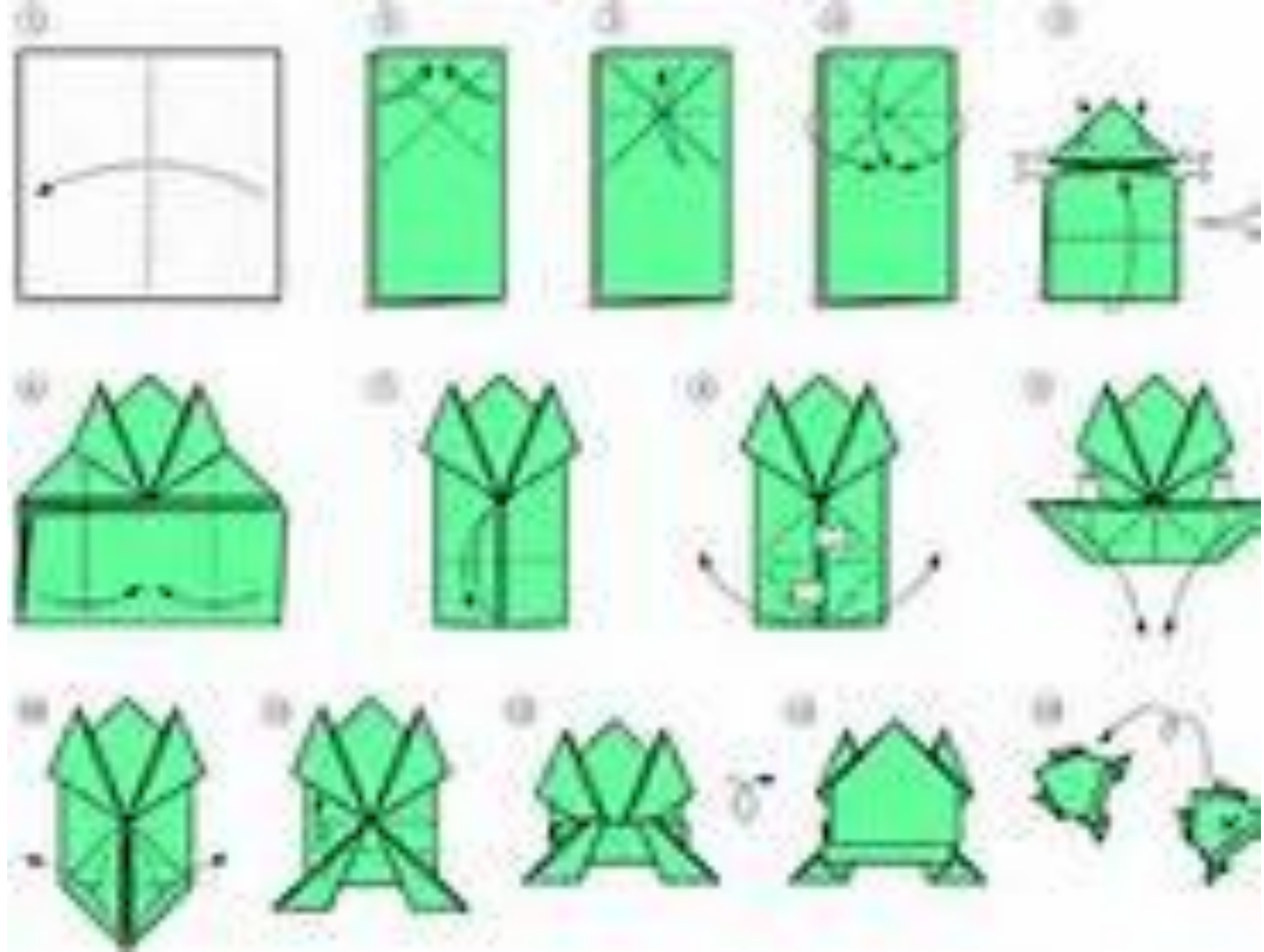



1

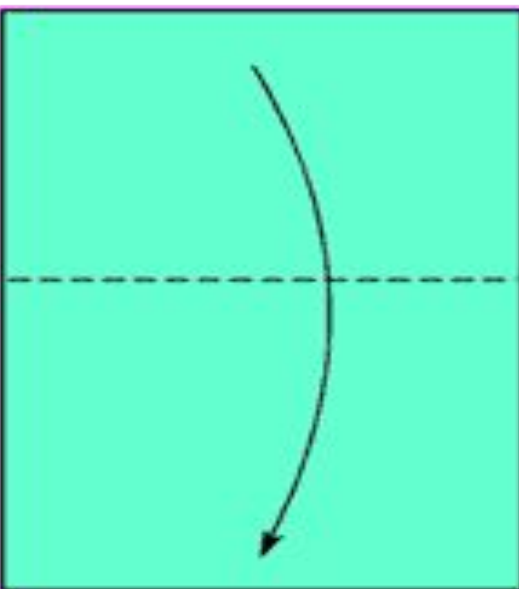

2

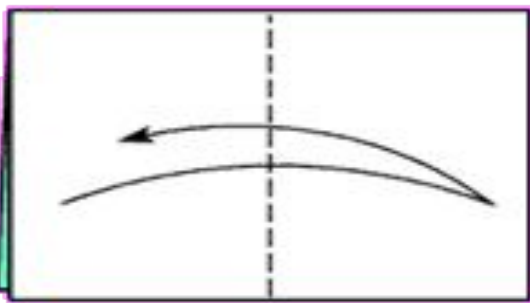

3

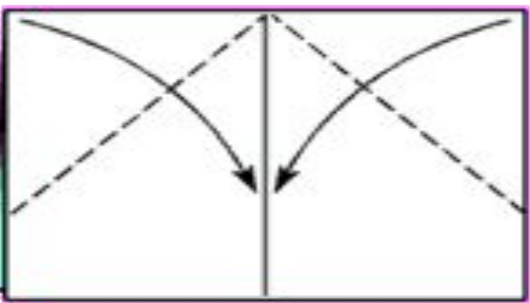

4

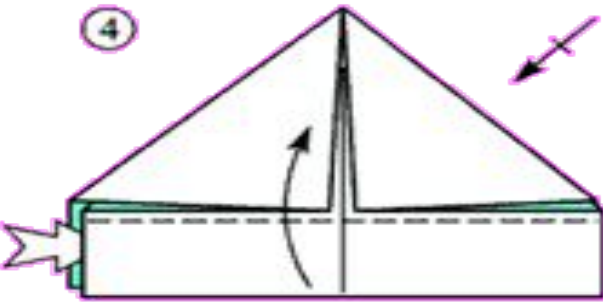

5

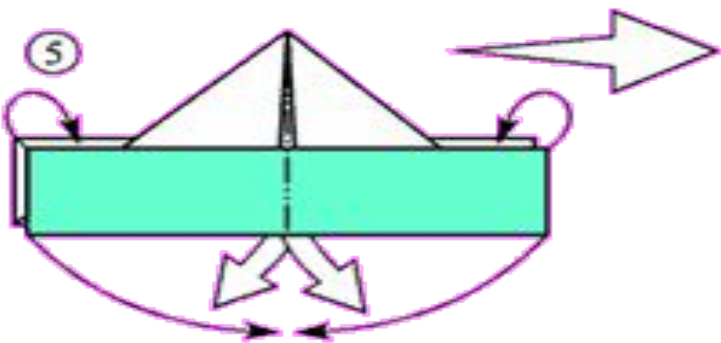

6

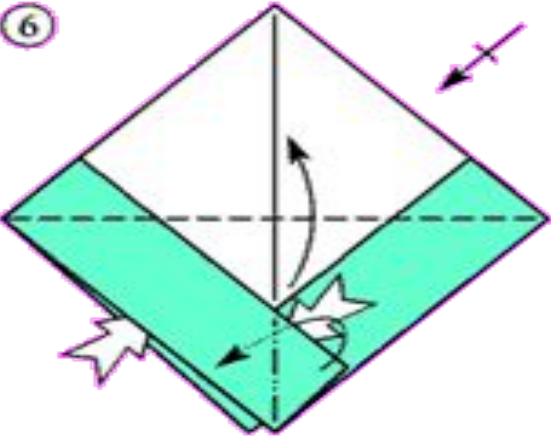

7

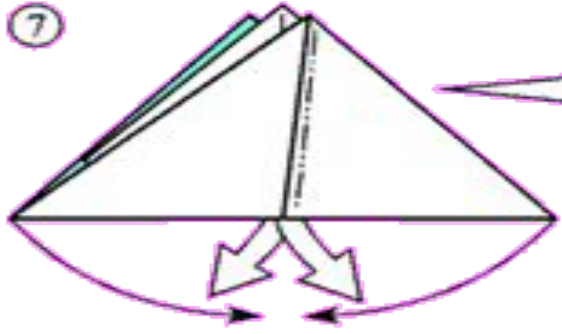

8

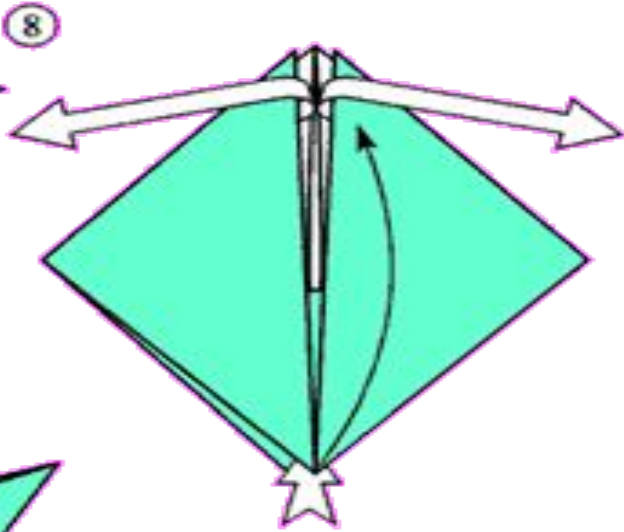

9

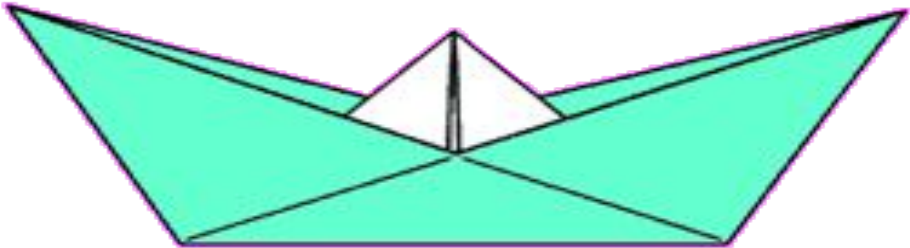

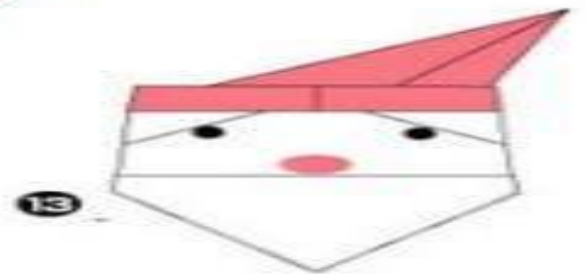
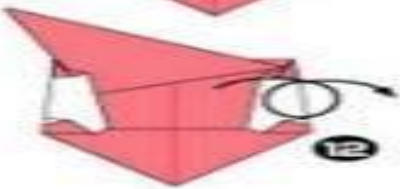
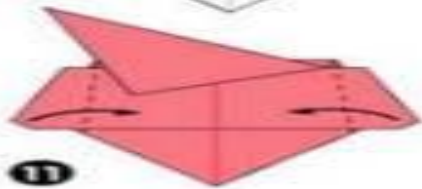
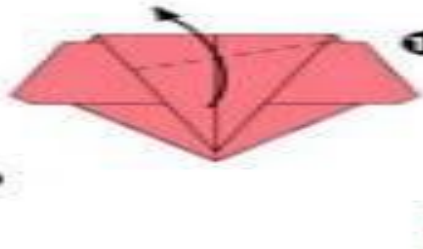
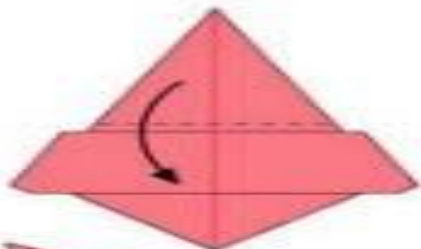
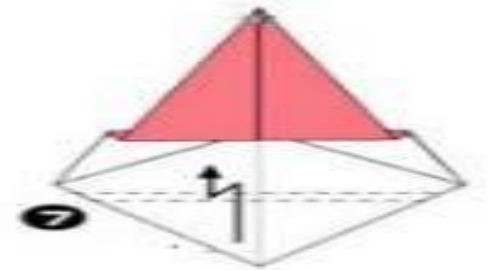
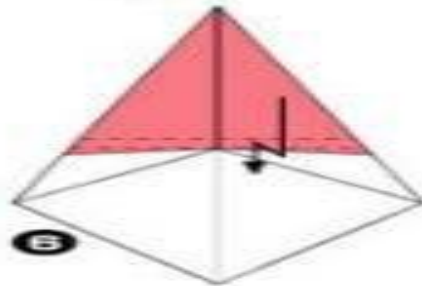
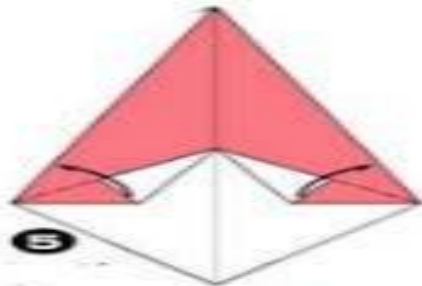
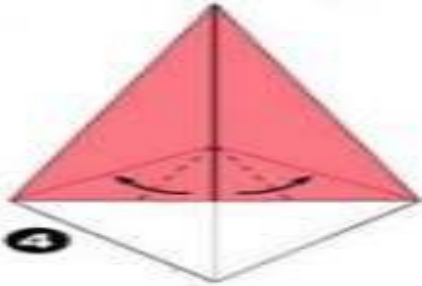
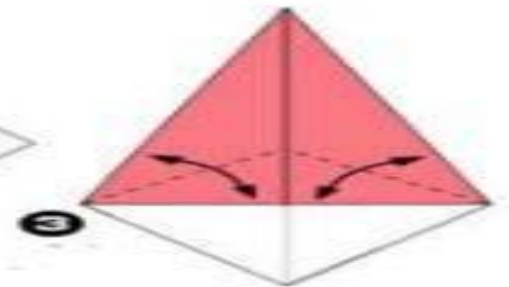
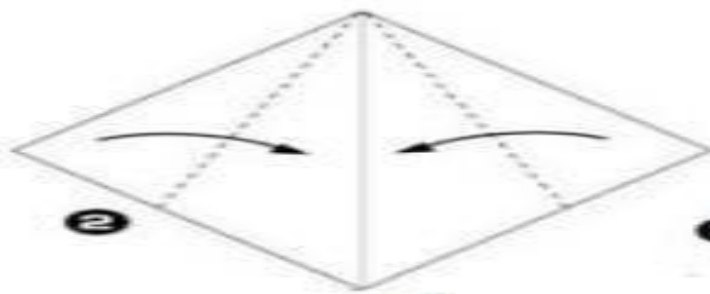
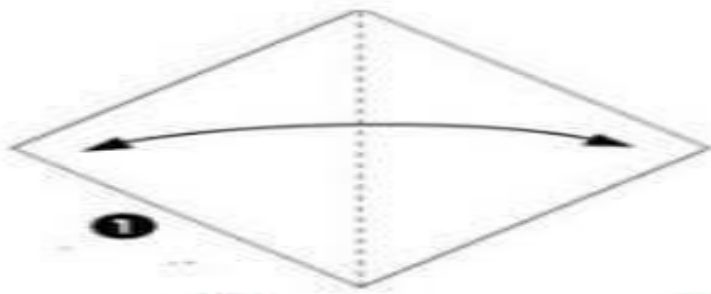



Возьмите лист бумаги



Заверните уголок так, чтобы он совпал с противоположной стороной

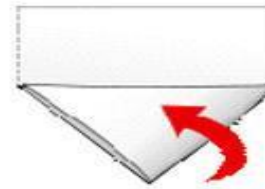

Заверните другой уголок так, чтобы он совпал с противоположной стороной



Обрежьте остаток бумаги сверху



Разверните лист. У вас получился квадрат

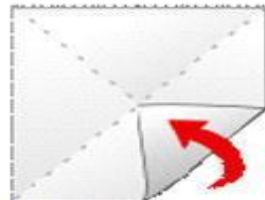

Сложите все четыре уголка так, чтобы они встретились в центре

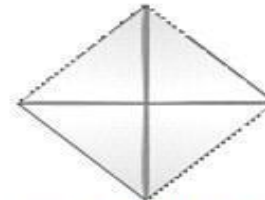

Теперь ваш лист бумаги должен выглядеть так

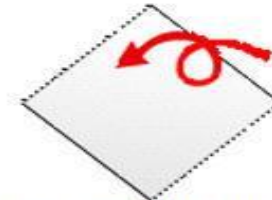

Переверните лист



Снова сложите все четыре уголка так, чтобы они встретились в центре



Теперь ваш лист должен выглядеть так

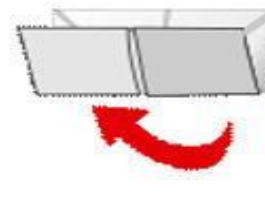

Сложите лист

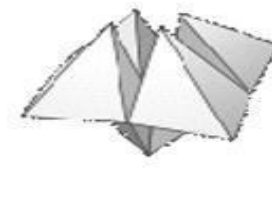

У вас получилось!!!

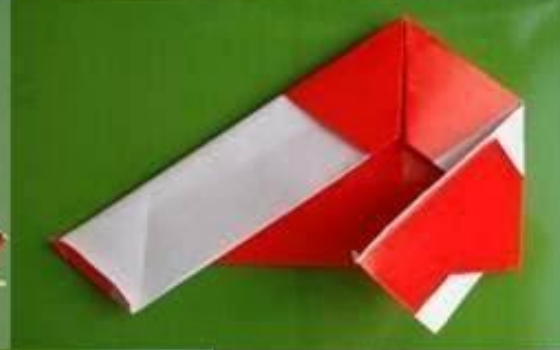
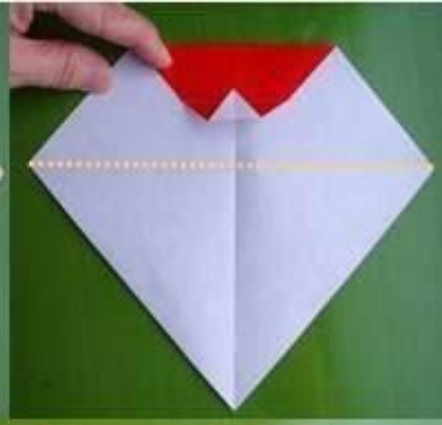
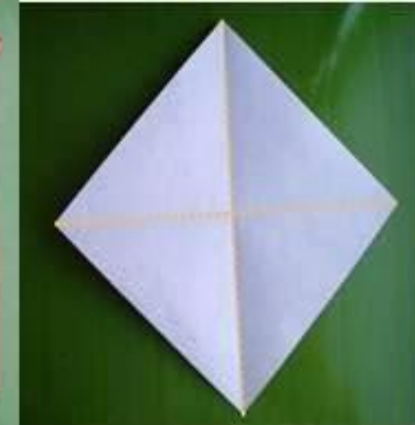

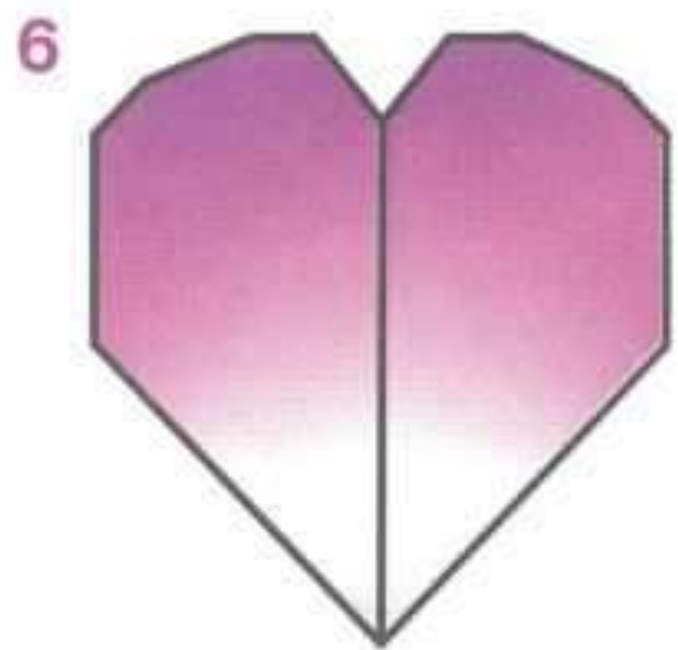
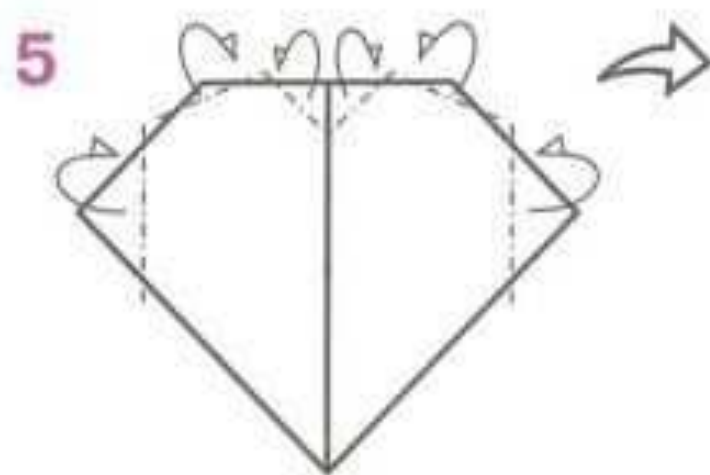
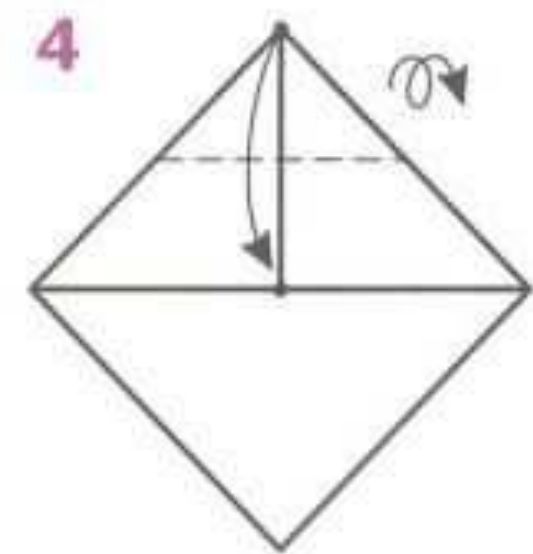
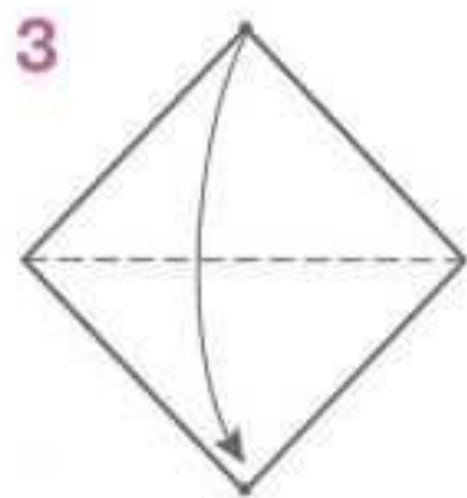
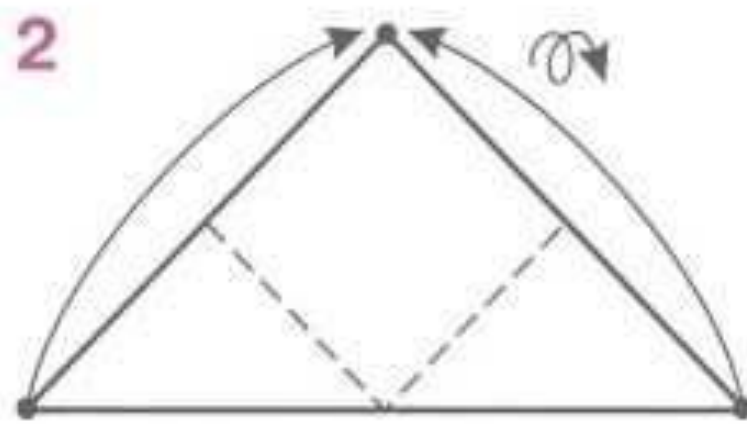
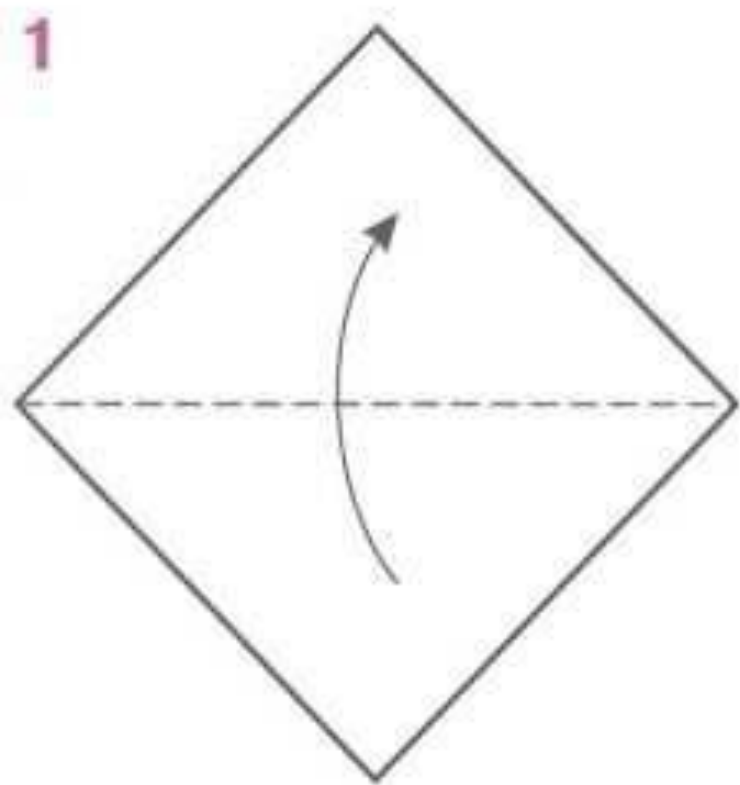

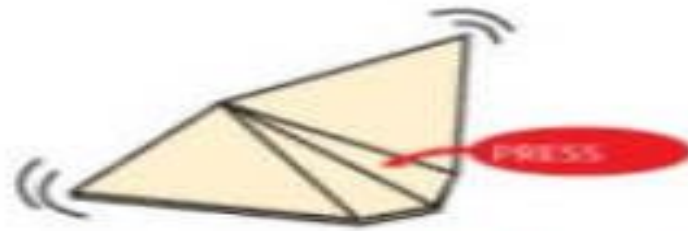
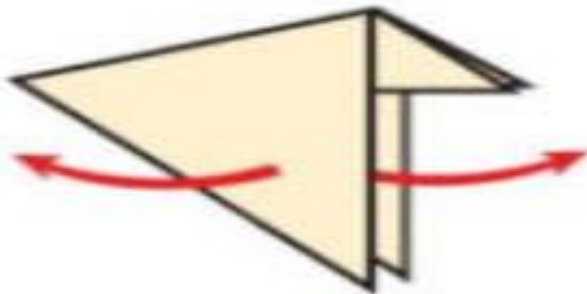
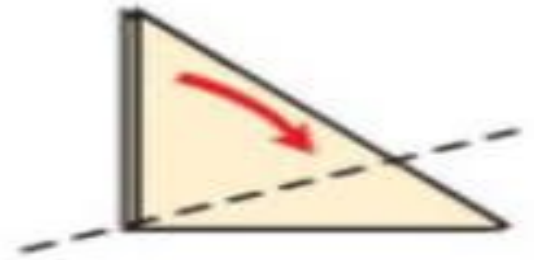
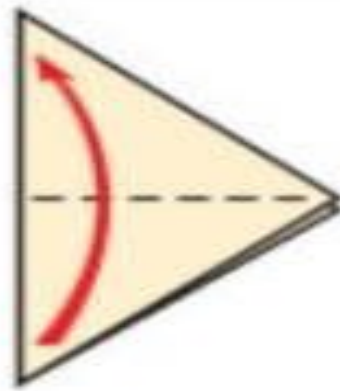
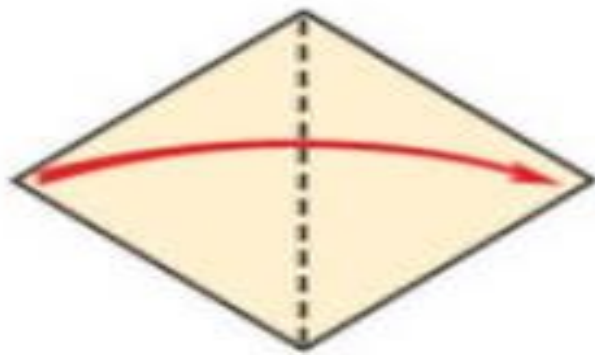

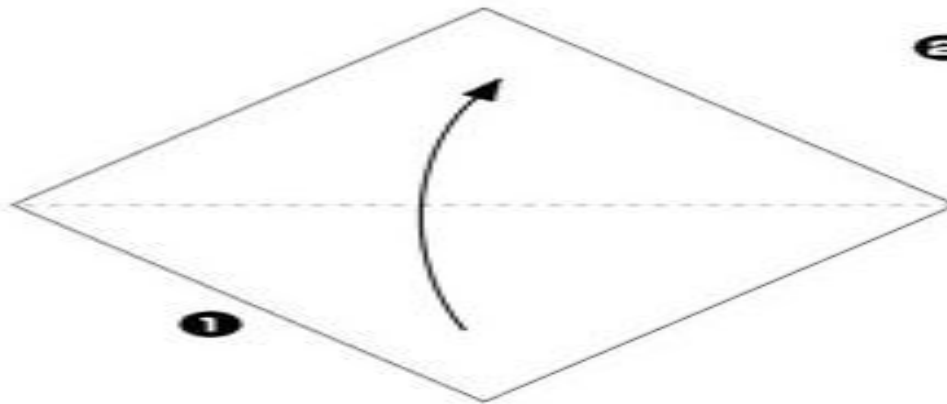

1

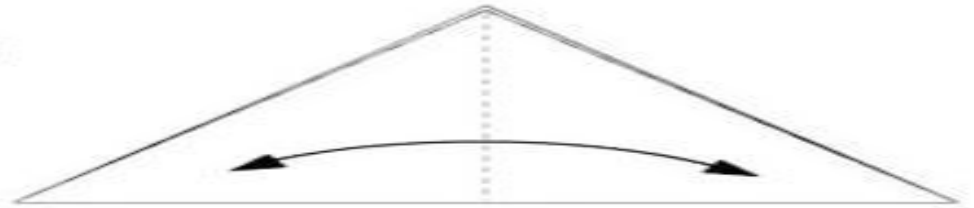

2

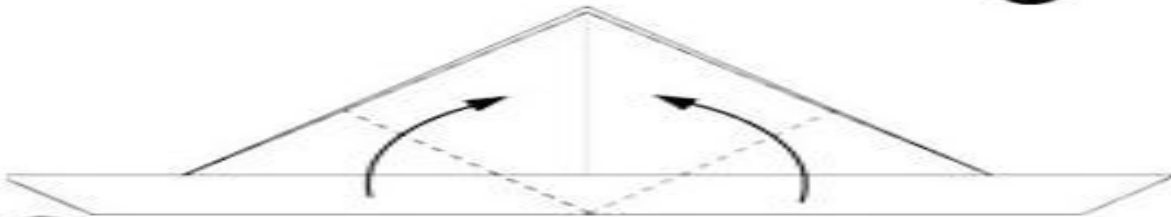

3

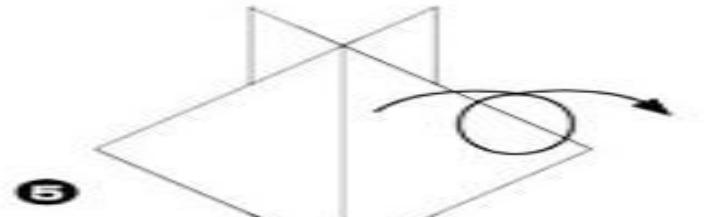

4

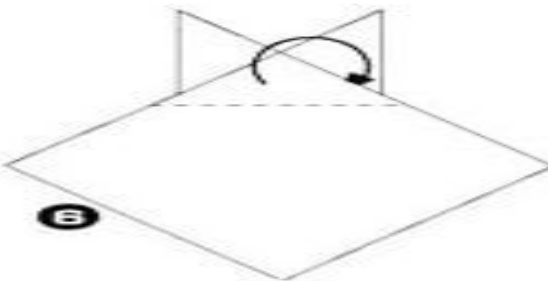

5

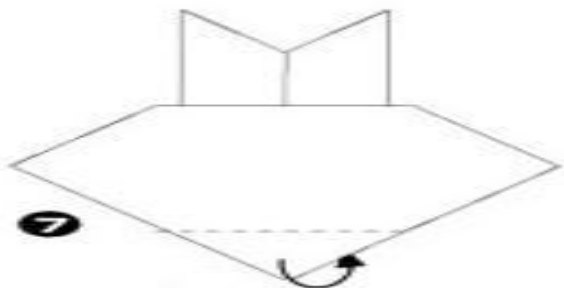

6

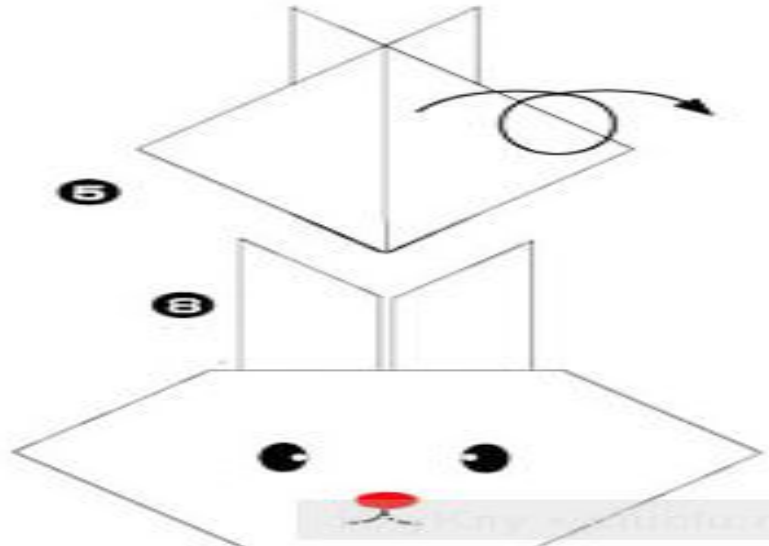

7

